

SCM1733ASA High Performance Current Mode PWM Controller

Features

- Extra Low Standby Loss(<75mW)
- Power-on Soft Start For Reducing MOS Stress
- Built-in 650V Power MOS
- Fixed 65KHz Switching Frequency
- Low VDD Startup and Operating Current
- Frequency Jitter for Softened EMI Signature
- Leading Edge Blanking on Current Sense and Slope Compensation
- Audio Noise Free Operation
- VDD Under Voltage Lockout with Hysteresis
- Cycle-by-Cycle Over Current Limiting
- Over Load Protection (OLP)
- Over Temperature Protection (OTP)
- VDD Over Voltage Protection (OVP)

Package

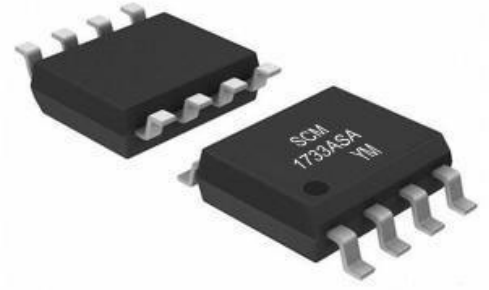

Product optional package: SOP-8, Screen Printing information please see "Order Information"

Applications

- AC/DC Adapter
- Set-Top Box Power Supplies
- Auxiliary Power Supply
- Open-frame SMPS

Features Description

The SCM1733ASA is a low power off-line SMPS Switcher optimized for off-line flyback converter applications in sub 20W power range. It is optimized for high performance, low standby power, and cost effective off line flyback converter application in sub 20W range.

Low startup current and low operating current contribute to a reliable power on startup and low standby loss design with SCM1733ASA.

SCM1733ASA offers complete protection coverage with automatic self recovery feature including Cycle-by-Cycle current limiting(OCP), over load protection(OLP), VDD under voltage lockout (UVLO), over temperature protection (OTP), and over voltage protection (OVP). Excellent EMI performance is achieved with internal frequency jitter technique and soft switching control at the totem pole gate drive output.

The tone energy at below 22KHz is minimized in the design and audio noise is eliminated.

SCM1733ASA is offered in SOP-8 package.

Selection Table

Model	Package	Topo	Control Mode	Protection Function	Power MOS	Power Range
SCM1733ASA	SOP-8	Flyback	Current Mode, SSR	OCP, OLP, OTP, SCP, UVLO, OVP	In Chip : 650V/4A	20W Max

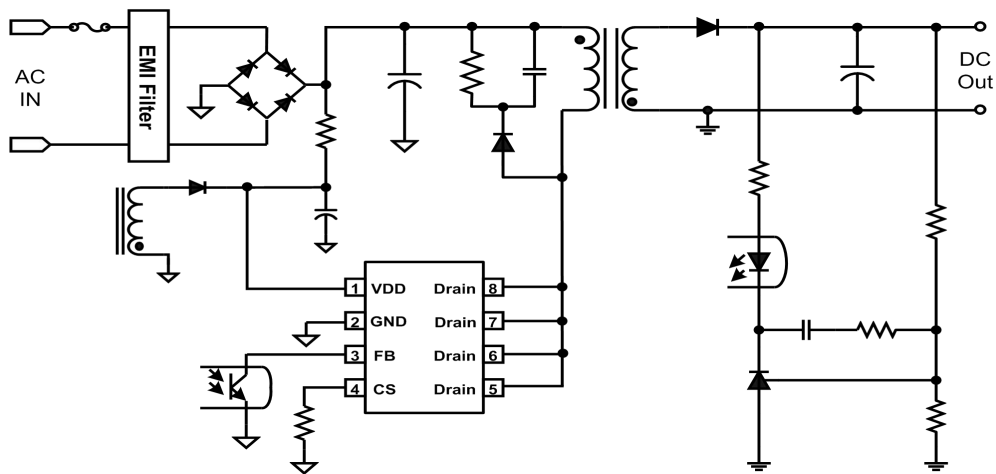

Contents

1 Home Page.....	1	4 Functional Description.....	6
1.1 Features and Package.....	1	4.1 Start up Current and Start Up Control.....	6
1.2 Applications.....	1	4.2 Operating Current.....	6
1.3 Features Description and Selection Table.....	1	4.3 Soft-Start.....	6
1.4 Typical Application.....	2	4.4 Multi-mode Operation for High Efficiency.....	6
2 Pin Package and Descriptions.....	2	4.5 Frequency Jitter for EMI Improvement.....	6
3 IC Relevant Parameter.....	3	4.6 Oscillator Operation.....	6
3.1 Absolute Maximum Ratings.....	3	4.7 Current Sensing and Leading Edge Blanking.....	7
3.2 Recommended Operating Parameters.....	4	4.8 Internal Synchronized Slope Compensation.....	7
3.3 Electrical Characteristics.....	4	4.9 Driver.....	7
3.4 Typical Performance Characteristics.....	5	4.10 Protection Controls.....	7
		5 Power Supply Usage Suggestion	7
		6 Ordering, Encapsulation and Packaging Information	8
		6.1 Ordering Information	8
		6.2 Encapsulation Information.....	8
		6.3 Packaging Information.....	9

Pin Package

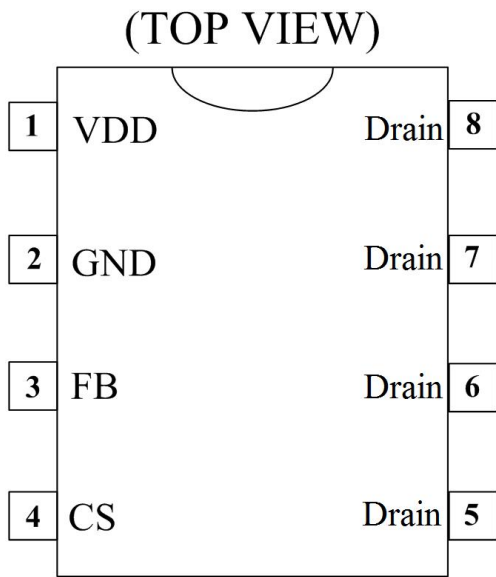

Block Diagram Circuit

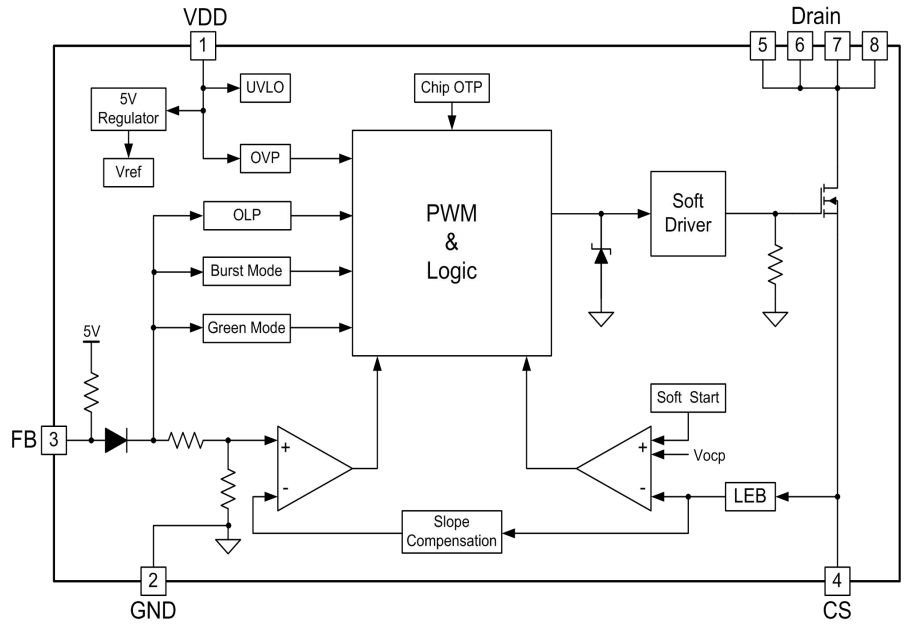

Pin Descriptions

Name	Pin	Description
VDD	1	Power Supply
GND	2	Ground
FB	3	Feedback Input Pin
CS	4	Current Sense Input and Power MOS Source
Drain	5/6/7/8	Power MOS Drain

Absolute Maximum Ratings

Symbol	Parameter	Min.	Max.	Unit
V_{Drain}	Drain Voltage(off state)		BVdss	V
I_{Drain}	Continuous Drain Current		4	A
V_{DD}	DC Supply Voltage		30	V
I_{DD}	VDD DC Clamp Current		10	mA
V_{FB}	FB Input Voltage	-0.3V	5	V
V_{CS}	CS Input Voltage	-0.3V	5	V
R_{JA}	SOP-8 Thermal Resistance (Junction-to-Air)		120	°C/W
T_J	Operating Junction Temperature	-40	150	°C
T_{STG}	Storage Temperature Range	-55	160	°C
T_L	Lead Temperature (Wave Soldering or IR,10Seconds)		260	°C
ESD	Human Body Model,JEDEC:JESD22-A114		2.5	KV
	Machine Model, JEDEC:JESD22- A115		250	V

Stresses beyond those listed under "absolute maximum ratings" may cause permanent damage to the device. These are stress ratings only, functional operation of the device at these or any other conditions beyond those indicated under "recommended operating conditions" is not implied. Exposure to absolute maximum-rated conditions for extended period may affect device's reliability.

Pin Configurations and Functions

Symbol	Parameter	Min.	Max.	Unit
V _{DD}	DC Supply Voltage	10	26	V
T _J	Operating Junction Temperature	-40	125	°C
P _{OMAX}	Output Power@90~264V Input		18	W
	Output Power@230V Input		20	

Maximum practical continuous power in an open frame design with sufficient drain pattern as a heat sink, at 45°C ambient. Higher output power is possible with extra added heat sink or air circulation to reduce thermal resistance.

Electrical Characteristics

T_A = 25°C, V_{DD}=18V, unless otherwise noted

Symbol	Parameter	Conditions	Min.	Typ.	Max.	Unit
Supply Voltage (VDD)						
I _{DD_ST}	Startup Current	V _{DD} =V _{DD_ON} -1V		2	5	uA
I _{DD_OP}	Operation Current	V _{FB} =3V		2.5	3.0	mA
I _{DD_Burst}	Burst Current	V _{CS} =0V, V _{FB} =0.5V		0.6	0.7	mA
V _{DD_ON}	Threshold Voltage to Startup	V _{DD} Rising	16.3	17.3	18.3	V
V _{DD_OFF}	Threshold Voltage to Stop Switching in Normal Mode	V _{DD} Falling	7.0	8.0	9.0	V
V _{Pull-up}	Pull-up PMOS Active			10		V
V _{DD_OVP}	Over Voltage Protection Voltage		27.0	28.0	29.0	V
V _{DD_Clamp}	VDD Clamp Voltage	I _{DD} =10mA		30.0		V
Feedback Input Section(FB Pin)						
V _{FB_Open}	FB Open Loop Voltage			4.8		V
A _V	PWM Input Gain ΔV _{FB} / ΔV _{CS}			1.71		V/V
D _{MAX}	Max Duty Cycle	V _{FB} =3V, V _{CS} =0.3V	77	80	83	%
V _{Ref_Green}	Enter Green Mode Threshold			2.1		V
V _{Ref_Burst_H}	Exit Burst Mode Threshold			1.35		V
V _{Ref_Burst_L}	Enter Burst Mode Threshold			1.25		V
I _{FB_Short}	FB Pin Short Circuit Current	Short FB pin to GND		0.3		mA
V _{TH_PL}	Power Limiting FB Threshold Voltage			3.6		V
T _{D_PL}	Power Limiting Delay			60		mS
Z _{FB_IN}	Input Impedance			20		KΩ
Current Sense Input(CS Pin)						
T _{SS}	Soft Start Time			5		ms
T _{LEB}	Leading Edge Blanking Time			300		ns
T _{D_OC}	Over Current Detection and Control Delay			90		ns
V _{TH_OC}	Current Limiting Threshold Voltage with Zero Duty Cycle			0.75		V
V _{OCP_Clamp}	CS Voltage Clamper			0.9		V
Oscillator						
F _{OSC}	Normal Oscillation Frequency	V _{FB} =3V, V _{CS} =0V	60	65	70	KHz
F _{JR}	Frequency Jitter Range			+/-4		%
F _{Jitter}	Jitter Frequency			25		Hz
F _{DT}	Frequency Variation vs. Temperature Deviation			5		%
F _{DV}	Frequency Variation vs. V _{DD} Deviation			1		%

Symbol	Parameter	Conditions	Min.	Typ.	Max.	Unit
F _{Burst}	Burst Mode Switch Frequency			22		KHz
Power MOS						
BV _{dss}	Drain-CS Breakdown Voltage	I _{Drain} =250uA	650			V
R _{DS(ON)}	Drain-CS ON Resistance	I _D =2.0A		2.1	2.5	Ω
In-chip OTP						
T _{OTP_EN}	OTP Enter			150		°C
T _{OTP_EX}	OTP Exit			120		°C

Typical Performance Characteristics

T_A = 25°C, V_{DD}=18V, unless otherwise noted

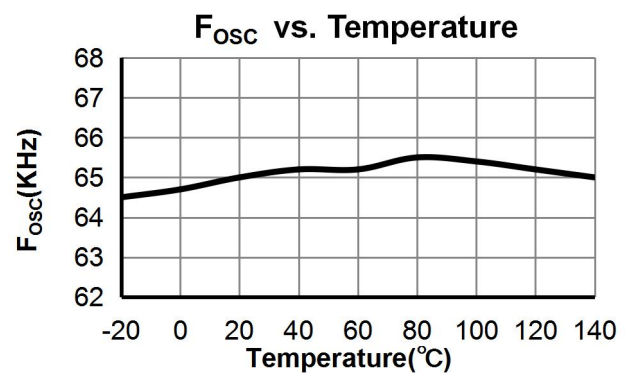
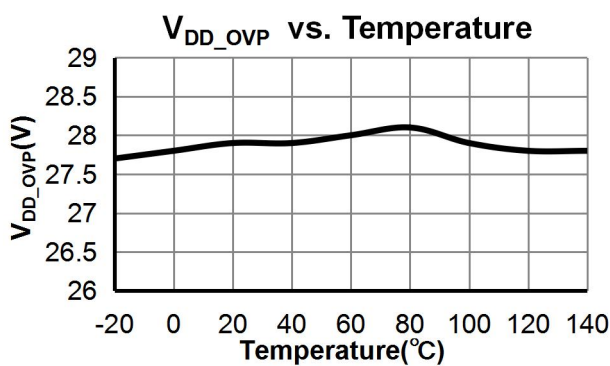
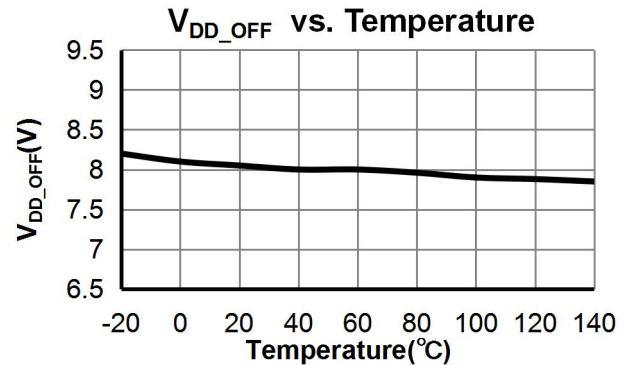
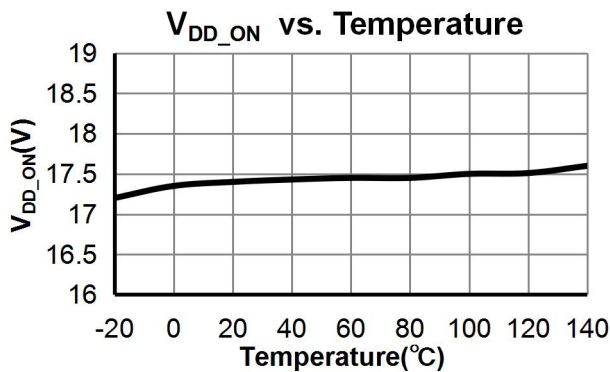
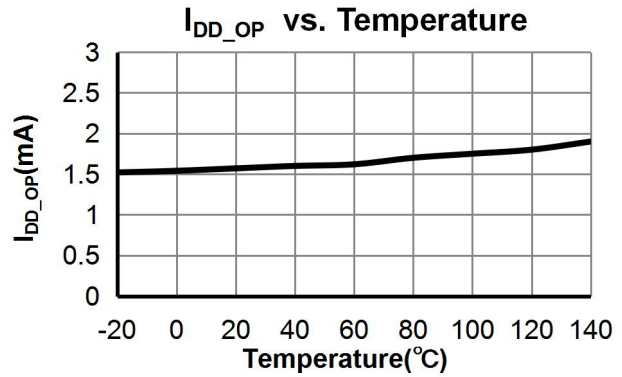
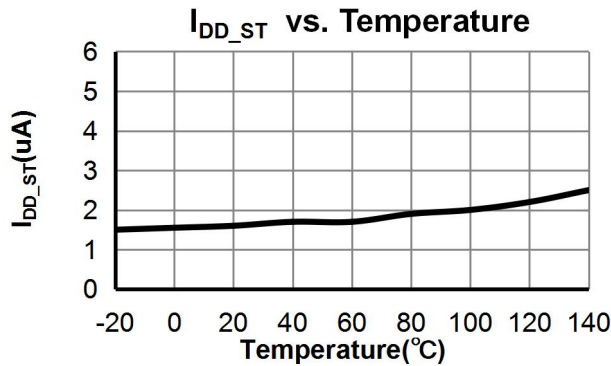

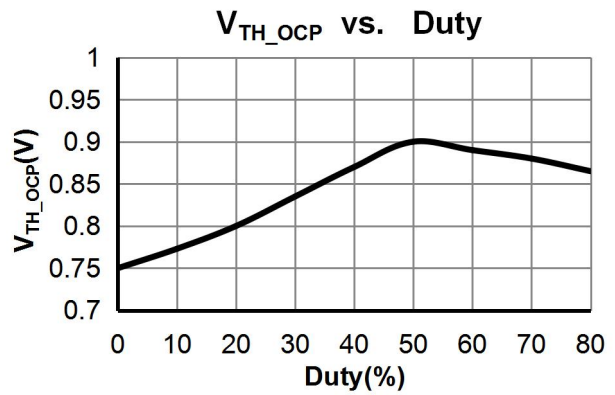
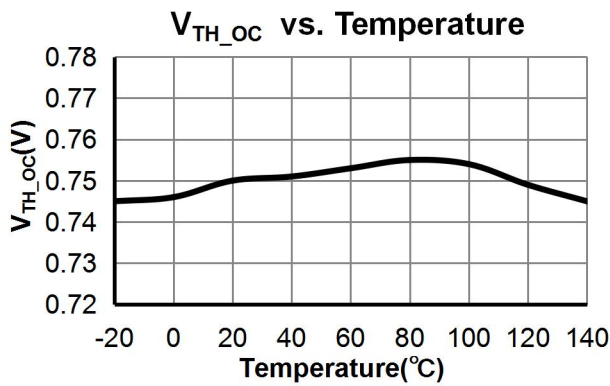

Functional Description

The SCM1733ASA is a low power off-line SMPS Switcher optimized for off-line flyback converter applications in sub 20W power range. The Burst Mode control greatly reduces the standby power consumption and helps the design easily to meet the international power conservation requirements.

Startup Current and Start up Control

Startup current of SCM1733ASA is designed to be very low so that VDD could be charged up above V_{DD_ON} and device starts up quickly. A large value startup resistor can be used to minimize the power loss to achieve a reliable startup in application.

Operating Current

The operating current of SCM1733ASA is low at 2.5mA(typical) and the burst mode working current is low at 600uA(typical), which can obtain good average efficiency and no-load power consumption.

Soft Start

SCM1733ASA features an internal 5ms (typical) soft start to soften the electrical stress occurring in the power supply during startup. It is activated during the power on sequence. As soon as VDD reaches V_{DD_ON}, the CS peak voltage is gradually increased from 0.05V to the maximum level. Every restart up is followed by a soft start.

Multi-mode Operation for High Efficiency

SCM1733ASA is a multi-mode controller. The controller changes the mode of operation according to the FB pin voltage. At the normal operating condition, the IC operates in traditional fix frequency (65KHz) PWM mode. As the output load current is decreased, the IC enter into green mode smoothly from the PWM mode. In this mode, the switching frequency will start to linearly decrease from 65KHz to 22KHz. So the switching loss is minimized and the high conversion efficiency can be achieved. At light load or no load condition, most of the power dissipation in a switching mode power supply is from switching loss of the MOS, the core loss of the transformer and the loss of the snubber circuit. The magnitude of power loss is in proportion to the switching frequency. Lower switching frequency leads to the reduction on the power loss and thus conserves the energy. The switching frequency is internally adjusted at no load or light load condition. The switch frequency reduces at light/no load condition to improve the conversion efficiency. At light load or no load condition, the FB input drops below V_{Ref_Burst_L} and device enters Burst Mode control. The Gate drive output switches when FB input rises back to V_{Ref_Burst_H}. Otherwise the gate drive remains at off state to minimize the switching loss and reduces the standby power consumption to the greatest extent.

Frequency jitter for EMI improvement

The frequency jitter is implemented in SCM1733ASA. The oscillation frequency is modulated so that the tone energy is spread out. The spread spectrum minimizes the conduction band EMI and therefore eases the system design.

Oscillator Operation

The switching frequency of SCM1733ASA is internally fixed at 65KHz. No external frequency setting components are required for PCB design simplification.

Current Sensing and Leading Edge Blanking

Cycle-by-Cycle current limiting is offered in SCM1733ASA current mode PWM control. The switch current is detected by a sense resistor into the CS pin. An internal leading edge blanking circuit chops off the sensed voltage spike at initial internal power MOSFET on state due to snubber diode reverse recovery and surge gate current of power MOSFET. The current limiting comparator is disabled and cannot turn off the internal power MOSFET during the blanking period. The PWM duty cycle is determined by the current sense input voltage and the FB input voltage.

Internal Synchronized Slope Compensation

Built-in slope compensation circuit adds voltage ramp into the current sense input voltage for PWM generation. This greatly improves the close loop stability at CCM and prevents the sub-harmonic oscillation and thus reduces the output ripple voltage.

Driver

The internal power MOSFET in SCM1733ASA is driven by a dedicated gate driver for power switch control. Too weak the gate driver strength results in higher conduction and switch loss of MOSFET while too strong gate driver strength results the compromise of EMI. A good tradeoff is achieved through the built-in totem pole gate design with right output strength and dead time control. The low idle loss and good EMI system design is easier to achieve with this dedicated control scheme.

Protection Controls

Good power supply system reliability is achieved with auto-recovery protection features including Cycle-by-Cycle current limiting (OCP), Under Voltage Lockout on VDD (UVLO), Over Temperature Protection (OTP), VDD Over Voltage Protection (OVP). The OCP is line voltage compensated to achieve constant output power limit over the universal input voltage range. At overload condition when FB input voltage exceeds power limit threshold value for more than TD_PL, control circuit reacts to shut down the converter. It restarts when VDD voltage drops below UVLO limit.

Power supply usage suggestion

Higher output power is possible with extra added heat sink or air circulation to reduce thermal resistance.

Ordering Information

Part number	Package		TOP MARK	Shipping
SCM1733ASA	SOP-8	Pb-free	SCM 1733ASA YM	Tape & Reel

Product Number and Silk Screen Description

SCM1733XYZ:

(1) SCM1733,Product Code.

(2) X = A-Z,Version Code.

(3) Y = S,Package Code; S,SOP.

(4) Z = C,I,A,M,Temperature Class Code; C,0°C-70°C; I,-40°C-85°C; A,-40°C-125°C; M,-55°C-125°C.

Silk Screen:

(5) YM,Product Traceability Code; Y,Product Birth Year Code; M,Product Birth Year Code.

Dimension Information

THIRD ANGLE PROJECTION 

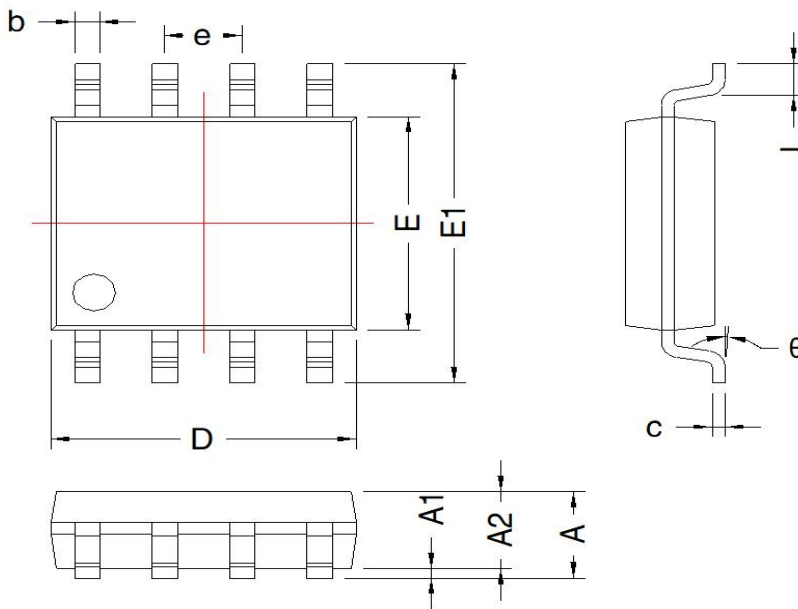

SOP-8				
Mark	Dimension(mm)		Dimension(inch)	
	Min	Max	Min	Max
A	1.35	1.75	0.053	0.069
A1	0.05	0.25	0.002	0.010
A2	1.25	1.65	0.049	0.065
D	4.7	5.15	0.185	0.203
E	3.8	4.0	0.150	0.157
E1	5.8	6.2	0.228	0.244
L	0.4	1.27	0.016	0.050
b	0.31	0.51	0.012	0.020
e	1.27TYP		0.05TYP	
c	0.17	0.25	0.0067	0.001
theta	0°	8°	0°	8°

Package Information

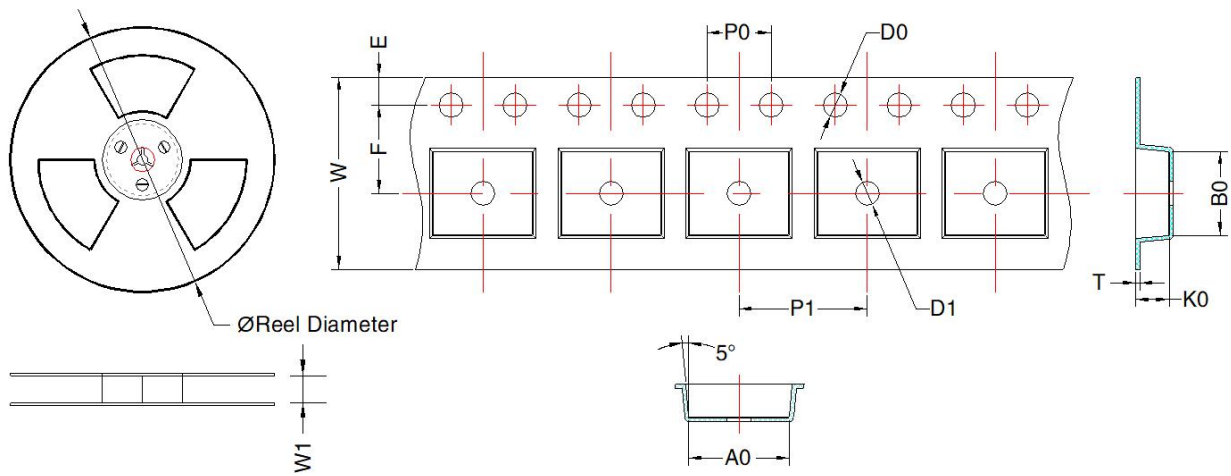

The orientation of IC in tape

 User Direction of Feed

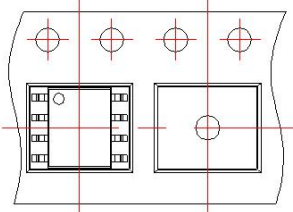

Device	Package Type	MPQ	Reel Diameter (mm)	Reel Width W1 (mm)	A0 (mm)	B0 (mm)	K0 (mm)	T (mm)	W (mm)	E (mm)	F (mm)	P1 (mm)	P0 (mm)	D0 (mm)	D1 (mm)
SCM1733ASA	SOP-8	4000	330.0	12.4	6.25 ± 0.1	5.3 ± 0.1	2.0 ± 0.05	0.2 ± 0.05	12.0 ± 0.3	1.75 ± 0.1	5.5 ± 0.1	8 ± 0.1	4 ± 0.1	1.5 ± 0.1	1.5 ± 0.1

Mornsun Guangzhou Science & Technology Co., Ltd.

Address: No. 5, Kehui St. 1, Kehui Development Center, Science Ave., Guangzhou Science City, Huangpu District, Guangzhou, P. R. China
 Tel: 86-20-38601850 Fax: 86-20-38601272 E-mail: info@mornsun.cn www.mornsun-power.com