

## 0/180 Degrees Bi-Phase Modulator from 500 MHz to 1 GHz with TTL Control, 15nsec Speed and SMA

The FM86GM2000 is a 0° to 180° Bi-Phase Modulator that operates across a frequency range from 500 MHz to 1000 MHz. This modulator takes a TTL level digital bit stream and encodes it onto the RF carrier using 2 Phase Shift Keying (2PSK). 2 Phase Shift Keying utilizes 2 phases which are separated by 180°. Impressive typical performance includes low insertion loss of 2.5 dB, 10 nsec speed (10-90% RF), 15 dB carrier suppression, and 0.5W CW maximum RF input power. The design is bidirectional with input and output RF ports, and employs dual bias voltages (+5/-5 Vdc) and integrated TTL processing to phase modulate the control data onto the RF, and operates across a wide temperature range of -40°C to +85°C. The rugged and compact package uses TTL, Bias, Ground pins, and field replaceable SMA Female connectors. The high reliability design meets MIL-STD-202 environmental test conditions for Humidity, Shock, Vibration, Altitude, and Temperature Cycle.

### Electrical Specifications

Description	Min	Typ	Max	Units
Frequency Range	500		1,000	MHz
RF Input Power (CW)			+20	dBm
Maximum Peak RF (Survival) 1μs Pulse Width			0.5	Watts
Impedance		50		Ohms
VSWR			2:1	
Insertion Loss		2.5	3	dB
Carrier Suppression		15		dB
Switching Speed		10	15	ns
Switching Speed (Falltime)		10	15	ns
Switch Delay (On)		50	75	ns
Switch Delay (Off)		55	75	ns
Phase State (Off)		0		degrees
Phase State (On)		180		degrees
Bias Voltage (+)		5		Volts
Bias Voltage (-)		-5		Volts
Bias Current @ +5 VDC			75	mA
Bias Current @ -5 VDC			20	mA

### Mechanical Specifications

<b>Size</b>		
Length	1 in	[25.4mm]
Width	1 in	[25.4 mm]
Height	0.5 in	[12.7 mm]
Weight	0.125 lbs	[56.7 g]

### Configuration

Design	Bi-Phase Modulator
Connector Option	Field Replaceable
RF Connector	SMA Female



### Features:

- 0° to 180° Bi-Phase Modulator module
- 2 Phase Shift Keying (2PSK) Modulation
- Frequency Range: 500 MHz to 1000 MHz
- Insertion Loss: 2.5 dB typ
- 10 nsec typ Speed (10-90% RF)
- Carrier Suppression: 15 dB
- Compact Package Design
- Field Replaceable SMA Connectors
- Dual Bias Voltage: +5/-5 Vdc
- Integrated TTL Driver
- -40°C to +85°C Operating Temperature
- Designed to meet MIL-STD-202 Test Conditions
- Bi-Directional Operation

### Applications:

- Communication Systems
- Microwave Radio
- Radar
- High Data Rate Test & Measurement
- Serial Data Transmission
- Basestation Infrastructure

Fairview Microwave  
301 Leora Ln., Suite 100  
Lewisville, TX 75056  
Tel: 1-800-715-4396 / (972) 649-6678  
Fax: (972) 649-6689  
[www.fairviewmicrowave.com](http://www.fairviewmicrowave.com)  
[sales@fairviewmicrowave.com](mailto:sales@fairviewmicrowave.com)

**Environmental Specifications**

**Temperature**

Operating Range -40°C to +85°C  
Storage Range -40°C to +100°C

**Other**

Humidity MIL-STD-202F, Method 103B Cond. B  
Shock MIL-STD-202F, Method 213B Cond. B  
Vibration MIL-STD-202F, Method 204D Cond. B  
Altitude MIL-STD-202F, Method 105C Cond. B  
Temperature Cycle MIL-STD-202F, Method 107D Cond. A

**Compliance Certifications** (see [product page](#) for current document)

**Plotted and Other Data**

Notes:

**Typical Performance Data**

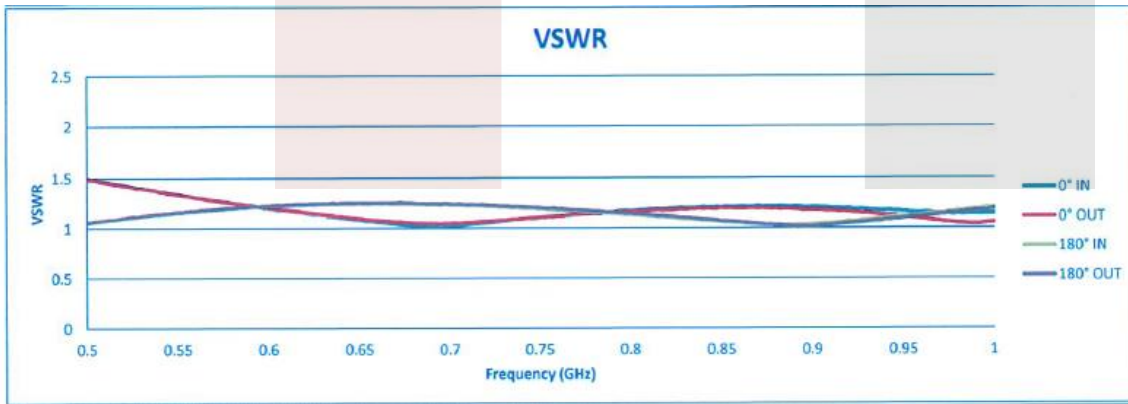
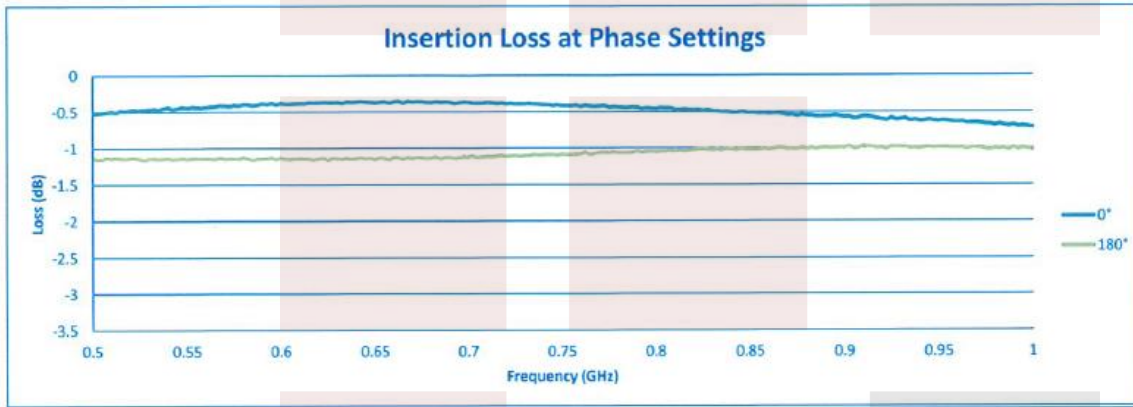

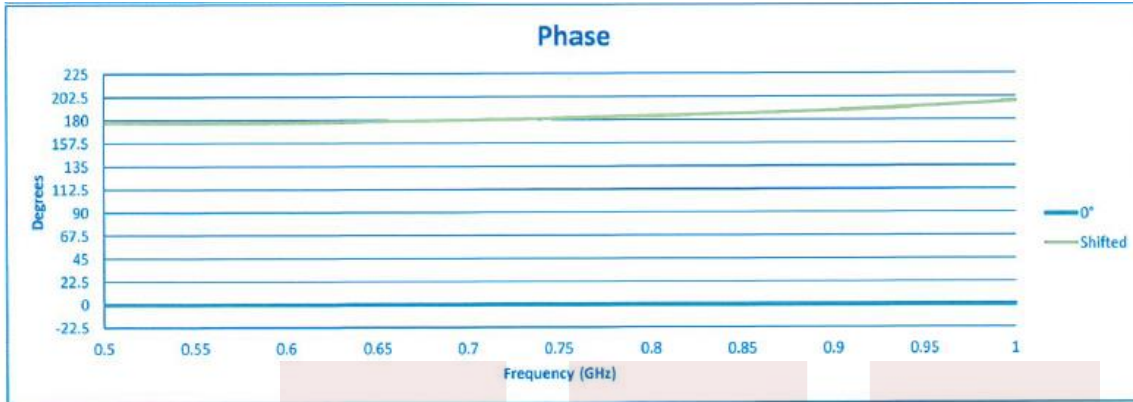

0/180 Degrees Bi-Phase Modulator from 500 MHz to 1 GHz with TTL Control, 15nsec Speed and SMA from Fairview Microwave is in-stock and available to ship same-day. All of our RF/microwave products are available off-the-shelf from our ISO 9001:2008 certified facilities in Lewisville, Texas. Fairview Microwave is RF on-demand.

For additional information on this product, please click the following link: [0/180 Degrees Bi-Phase Modulator from 500 MHz to 1 GHz with TTL Control, 15nsec Speed and SMA FM86GM2000](#)

URL: <https://www.fairviewmicrowave.com/undefined-url-for-pn-fm86gm2000-fm86gm2000-p.aspx>

The information contained in this document is accurate to the best of our knowledge and representative of the part described herein. It may be necessary to make modifications to the part and/or the documentation of the part, in order to implement improvements. Fairview Microwave reserves the right to make such changes as required. Unless otherwise stated, all specifications are nominal. Fairview Microwave does not make any representation or warranty regarding the suitability of the part described herein for any particular purpose, and Fairview Microwave does not assume any liability arising out of the use of any part or documentation.

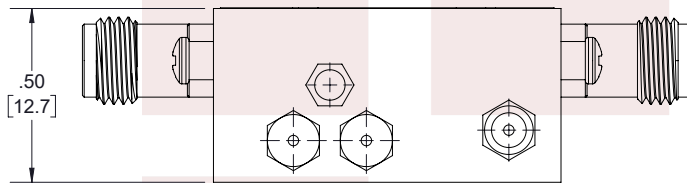
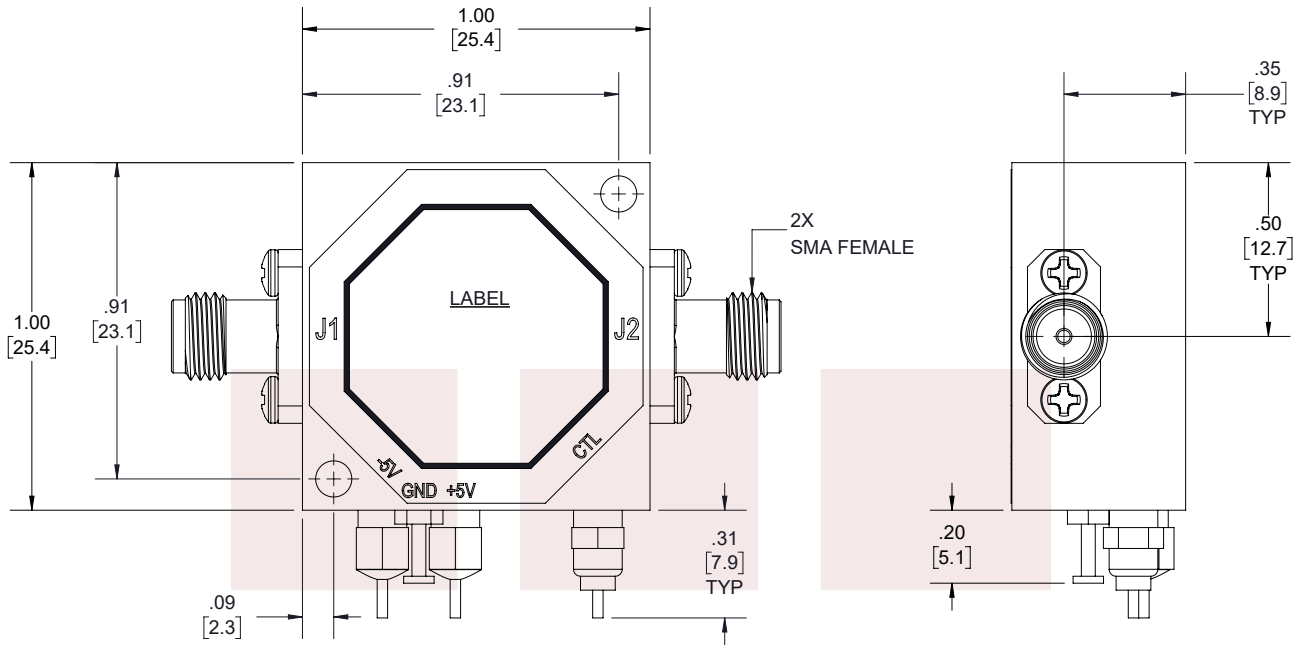

**LABEL**



**Fairview Microwave**  
 an INFINIT<sup>®</sup> brand  
 PHASE SHIFTER  
 MODEL NO:  
**FM86GM2000**  
 SERIAL NO:  
 PLXXXX/XXXX 

**STANDARD TOLERANCES**

- .X ±0.2
- .XX ±0.01
- .XXX ±0.005

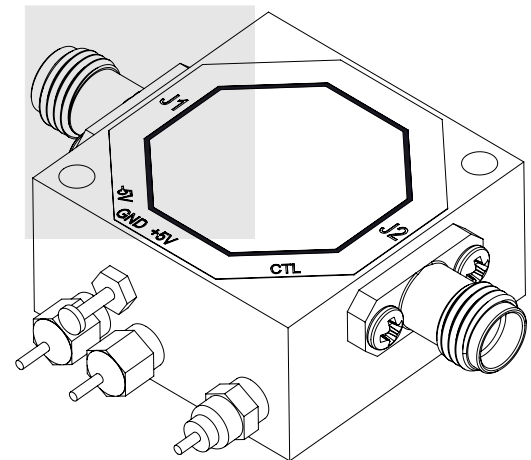
\*STANDARD TOLERANCES APPLY ONLY TO DIMENSIONS IN INCHES



 <b>Fairview Microwave</b> an INFINIT <sup>®</sup> brand		NOTES: 1. UNLESS OTHERWISE SPECIFIED ALL DIMENSIONS ARE NOMINAL. 2. ALL SPECIFICATIONS ARE SUBJECT TO CHANGE WITHOUT NOTICE AT ANY TIME. 3. DIMENSIONS ARE IN INCHES [mm].				
TITLE 0/180 Degrees Bi-Phase Modulator from 500 MHz to 1 GHz with TTL Control, 15nsec Speed and SMA		DWG NO <b>FM86GM2000</b>		CAGE CODE <b>3FKR5</b>		
CAD FILE	05/09/18	SHEET	1 OF 1	SCALE	N/A	SIZE A 7361