

Features

Regulated Converter

- 1.8"x3.2"x1.2", encapsulated module
- 40W power from -40°C up to +65°C ambient
- Operating temp. up to +85°C with derating
- 4 kVac/1min reinforced isolation
- 2MOPP medical certified, B and BF compliant
- 5000m (medical/ITE) operating altitude
- Class B EMC filter built-in



RACM40-K

40 Watt
1.8" x 3.2"
Single Output



Description

The ultra-compact encapsulated industrial + household + medical grade AC/DC converter series RACM40-K delivers 40 watts of output power from -40°C to +65°C with natural air convection only, and up to +85°C with derating or forced air cooling. With a clear focus on extended thermal performance for systems where space is limited, these 1.8" x 3.2" compact modules are designed to gain highest overall efficiency levels over the full output load range from universal AC inputs. The RACM40-K has ANSI/AAMI/IEC 60601-1 medical safety and EN 60601-1-2 medical EMC certifications and offers 4kVac/1 min isolation, 2MOPP, and is designed to meet B and BF requirements. It is additionally certified (CB Report) to IEC/EN 62368-1; IEC61010 and IEC61558-1/-2-16 for industrial applications and IEC/EN 60335-1 for household appliances. The robust built-in class B EMC filter has sufficient margin to allow either Class II or Class I PELV with grounded output installations. The mechanically rugged construction with fully potted encapsulation, 1,6mm pins and additional threaded inserts gives the series enhanced stability against shock and vibrations.

Selection Guide

Part Number	Input Voltage Range [VAC]	Output Voltage [VDC]	Output Current [mA]	Efficiency typ. ⁽¹⁾ [%]	Max. Output Power [W]
RACM40-05SK-T	80-264	5	6000	87	30
RACM40-12SK-T	80-264	12	3334	90	40
RACM40-15SK-T	80-264	15	2667	90	40
RACM40-24SK-T	80-264	24	1667	90	40
RACM40-48SK-T	80-264	48	833	90	40

Notes:

Note1: Efficiency is tested at +25°C with constant resistant mode at full load and 230VAC

Selection Guide (on request MOQ ≥1008pcs)

Part Number	Input Voltage Range [VAC]	Output Voltage [VDC]	Output Current [mA]	Efficiency typ. ⁽¹⁾ [%]	Max. Output Power [W]
RACM40-18SK-T	80-264	18	2222	90	40
RACM40-36SK-T	80-264	36	1111	90	40

- IEC/EN62368-1 (pending)
- ANSI/AAMI ES60601-1 certified
- CSA/CAN-C22.2 No. 60601-1:14 certified
- IEC/EN60601-1 certified
- IEC/EN60335-1 (pending)
- IEC/EN61010-1 (pending)
- EN62233 (pending)
- IEC/EN61558-1 (pending)
- IEC/EN61558-2-16 (pending)
- EN55032/35 compliant
- IEC/EN60601-1-2 compliant
- CB Report (pending)

Model Numbering

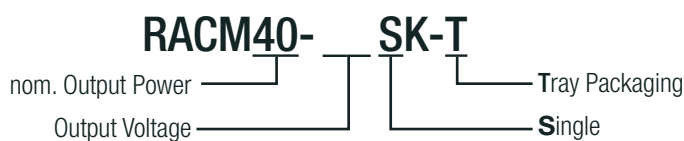

Specifications (measured @ Ta= 25°C, nom. Vin, full load and after warm-up unless otherwise stated)

BASIC CHARACTERISTICS					
Parameter	Condition		Min.	Typ.	Max.
Nominal Input Voltage	60Hz 50Hz		100VAC		240VAC
Operating Range ⁽²⁾	47-63Hz DC		80VAC 120VDC		264VAC 370VDC
Input Current	115VAC 230VAC				1000mA 500mA
Inrush Current	cold start	115VAC 230VAC			15A 30A
No load Power Consumption	230VAC			100mW	
ErP Standby Mode Conformity (Maximum output power available for stated maximum input power)	115VAC	RACM40 input power max. 0.5W	0.3W		
		RACM40 input power max. 1.0W	0.7W		
	230VAC	RACM40 input power max. 0.5W	0.27W		
		RACM40 input power max. 1.0W	0.65W		
Input Frequency Range			47Hz		63Hz
Minimum Load			0%		
Power Factor	115VAC 230VAC		0.6 0.5		
Start-up Time				160ms	
Rise Time				70ms	
Hold-up Time	115VAC 230VAC		16ms 60ms		
Internal Operating Frequency	100% load at nominal Vin			100kHz	
Output Ripple and Noise ⁽³⁾	20MHz BW	5Vout others			80mVp-p 1% of Vout

Notes:

Note2: The products were submitted for safety files at AC-Input operation

Note3: Measurements are made with a 0.1µF MLCC & 10µF E-cap in parallel across output. (low ESR)

Efficiency vs. Load

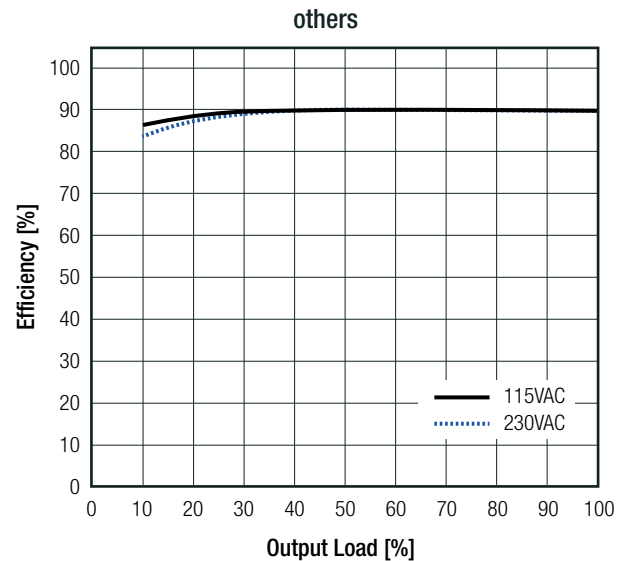
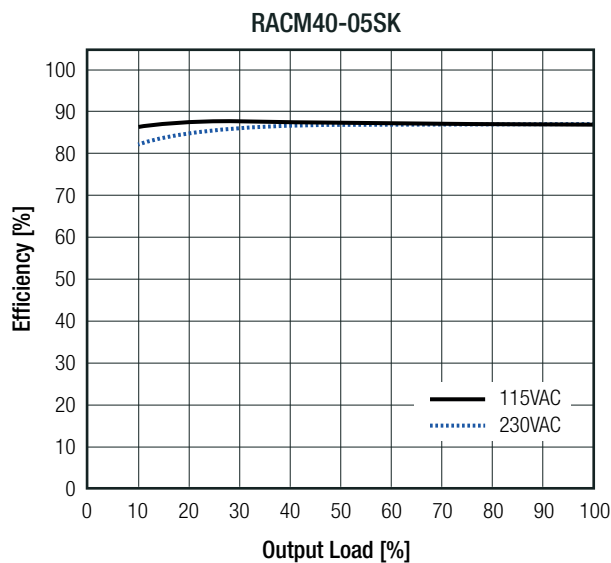

Specifications (measured @ Ta= 25°C, nom. Vin, full load and after warm-up unless otherwise stated)

REGULATIONS			
Parameter	Condition		Value
Output Accuracy			±1.0% typ. / ±2.0% max.
Line Regulation	low line to high line	5Vout others	±0.1% typ. ±0.05% typ.
Load Regulation ⁽⁴⁾	10% to 100% load	5, 12, 15Vout	0.7% typ.
		24, 48Vout	0.5% typ.
Transient Response	25% load step change		3.0% max.
	recovery time		500µs max.

Notes:

Note4: Operation below 10% load will not harm the converter, but specifications may not be met

Deviation vs. Load

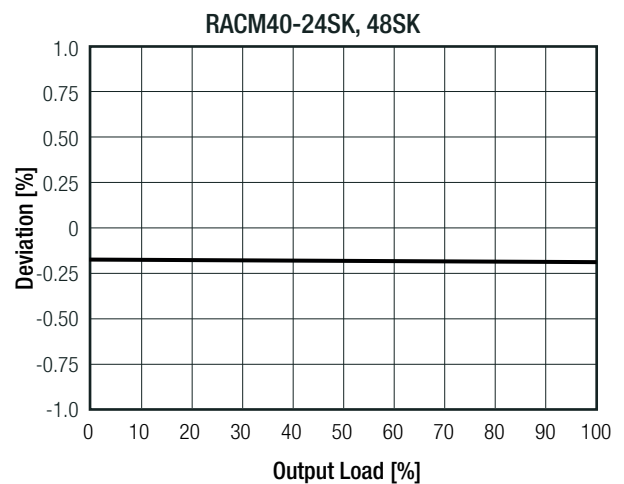
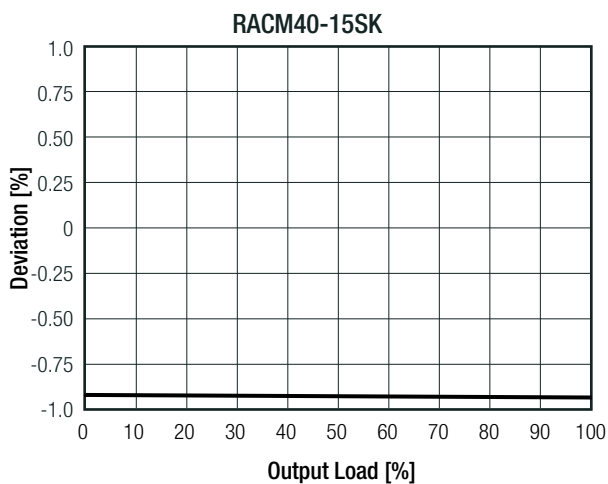
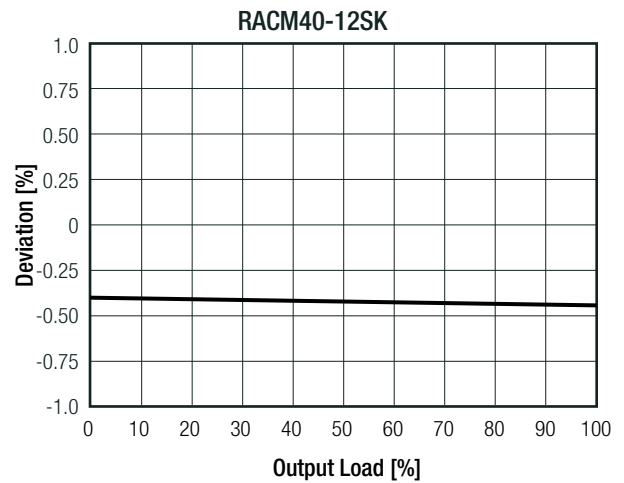
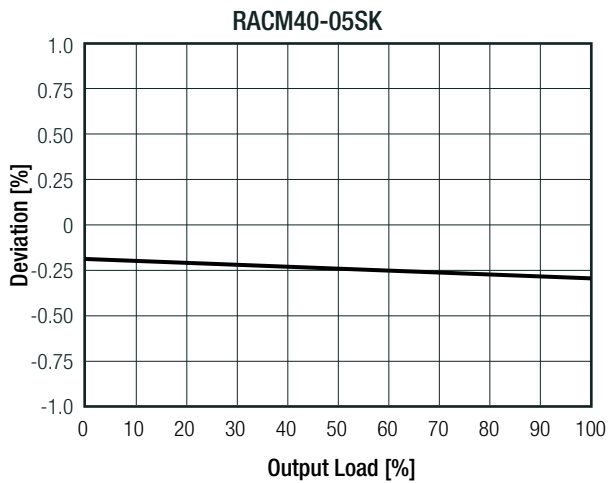

PROTECTIONS		
Parameter	Type	Value
Internal Input Fuse		T3.15A, slow blow type
Short Circuit Protection (SCP)	below 100mΩ	hiccup, auto recovery
Over Voltage Protection (OVP)		105% - 120% of nom. Vout, hiccup mode
Output reverse Voltage Protection	overrun rate of nominal output	107% - 145% of nom. Vout, hiccup mode

continued on next page

Specifications (measured @ Ta= 25°C, nom. Vin, full load and after warm-up unless otherwise stated)

Parameter	Type/Condition		Value
Over Current Protection (OCP)			130% - 180% of nom. Iout, hiccup mode
Thermal Shutdown	measured on TC point refer to <i>"Dimension Drawing (mm)"</i>		+130°C typ.
Over Voltage Category (OVC)			OVCII
Class of Equipment			Class II
Isolation Voltage (safety certified) ⁽⁵⁾	I/P to O/P	1 minute	4kVAC
Isolation Resistance	I/P to O/P	I/P to O/P, Viso= 500VDC	1GΩ min.
Isolation Capacitance	I/P to O/P	I/P to O/P, 100KHz/0.1V	100pF max.
Leakage Current			1.5mA max.
Insulation Grade			reinforced

Notes:

Note5: For repeat Hi-Pot testing, reduce the time and/or the test voltage

ENVIRONMENTAL

Parameter	Condition		Value
Operating Temperature Range	@ natural convection 0.1m/s (refer to <i>"Derating Graph"</i>)	without derating with derating	-40°C to +60/65°C -40°C to +85°C
Max. Case Temperature			100°C
Temperature Coefficient			±0.02%/K
Thermal Impedance			6.3K/W
Operating Altitude ⁽⁶⁾	according to 62368-1/61010 and 60601-1		5000m
Operating Humidity	non-condensing		20% - 95% RH max.
Pollution Degree			PD2
Vibration	according to MIL-STD-202G		10-500Hz, 2G 10min./1cycle, period 60min. along x,y,z axes
MTBF	according to MIL-HDBK-217F, G.B.	+25°C +40°C	>1006 x 10 ³ hours >790 x 10 ³ hours
Design Lifetime	230VAC/60Hz and full load +40°C		>98 x 10 ³ hours

Notes:

Note6: Recognized by safety agency for safe operation up to 5000m. High altitude operation may impact the performance and lifetime. Please contact RECOM tech support for advice

Derating Graph

(@ Chamber and natural convection 0.1m/s)

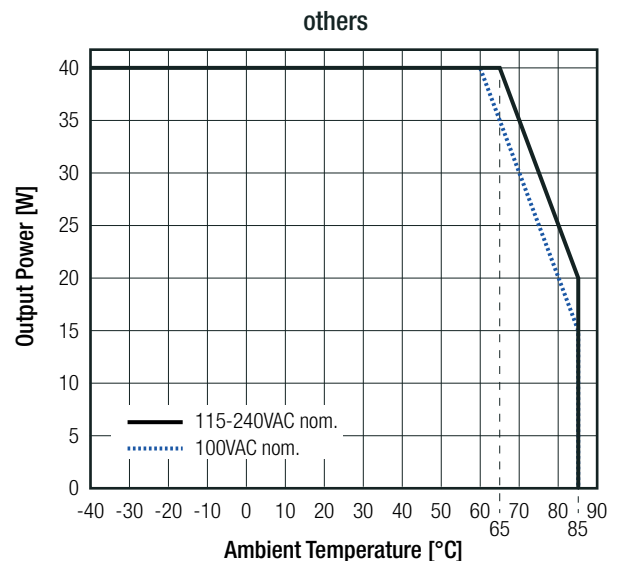
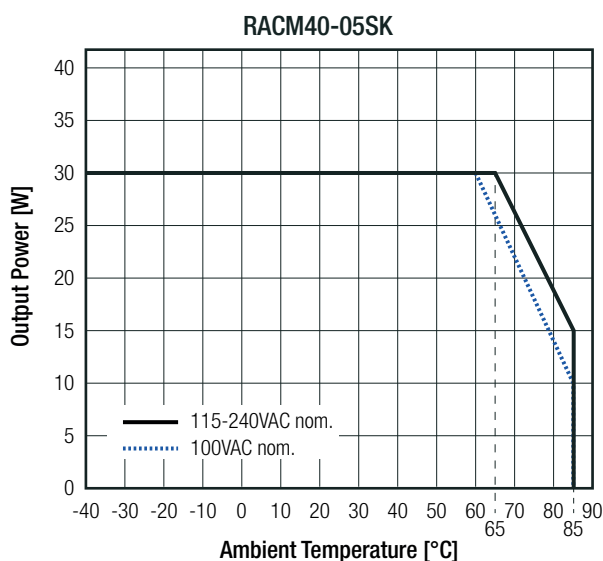

Notes:

Note7: Output power derating for Line-input of less than 90VAC (derate linearly from 100% at 90VAC to 80% at 80VAC)

Specifications (measured @ Ta= 25°C, nom. Vin, full load and after warm-up unless otherwise stated)

SAFETY AND CERTIFICATIONS		
Certificate Type (Safety)	Report / File Number	Standard
Medical electrical equipment Part 1: General requirements for basic safety and essential performance	E511305-D1001-1/A0/C0-UL	ANSI/AAMI ES60601-1:2005 + A2:2010/2012 CAN/CSA-C22.2 No. 60601-1:14, 3rd Edition
Medical electrical equipment Part 1: General requirements for basic safety and essential performance		IEC60601-1:2005, 3rd Edition + AM1:2012 EN60601-1:2006 + A1:2013
Audio/Video, information and communication technology equipment - Safety requirements (CB Scheme)	pending	IEC62368-1:2014 2nd Edition
Audio/Video, information and communication technology equipment - Safety requirements (LVD)	pending	EN62368-1:2014 + A11:2017
Household and similar electrical appliances – Safety – Part 1: General requirements	pending	IEC60335-1:2010 5th Edition + C1:2016
Household and similar electrical appliances – Safety – Part 1: General requirements (LVD)	pending	EN60335-1:2012 + A14:2019
Electrical Equipment For Measurement, Control, and Laboratory Use; Part 1: General Requirements (CB Scheme)	pending	IEC61010-1:2010+A1:2016, 3rd Edition
Electrical Equipment For Measurement, Control, and Laboratory Use; Part 1: General Requirements	pending	EN61010-1:2010+A1:2019
Measurement methods for electromagnetic fields of household appliances and similar apparatus with regard to human exposure	pending	EN62233:2008
Safety of power transformers, power supplies, reactors & similar products for supply voltages up to 1100V (CB Scheme)	pending	IEC61558-1:2005 2nd Edition + A1:2009
Safety of power transformers, power supplies, reactors & similar products for supply voltages up to 1100V	pending	EN61558-1:2005 + A1:2009
Safety of power transformers, power supplies, reactors & similar products for supply voltages up to 1100 V Part 2: Particular requirements (CB Scheme)	pending	IEC61558-2-16:2009 1st Edition + A1:2013
Safety of power transformers, power supplies, reactors & similar products for supply voltages up to 1100 V Part 2: Particular requirements	pending	EN61558-2-16:2009 + A1:2013
RoHS2		RoHS 2011/65/EU + AM2015/863
EMC Compliance (Medical)		
	Condition	Standard / Criterion
Medical electrical equipment - Part 1-2: General requirements for basic safety and essential performance - Collateral standard: Electromagnetic compatibility - Requirements and tests 4th Ed.	4789293779	EN60601-1-2:2015
ESD Electrostatic discharge immunity test	Air ±2, 4, 8, 15kV; Contact ±8kV	IEC61000-4-2:2008 , Criteria A EN61000-4-2:2009, Criteria A
Radiated, radio-frequency, electromagnetic field immunity test	9V/m (710, 745, 780, 5240, 5500, 5785MHz) 10V/m (80-2700MHz) 27V/m (385MHz) 28V/m (450, 810, 870, 930, 1720, 1845, 1970, 2450MHz)	IEC/EN61000-4-3:2006 + A2:2010, Criteria A
Fast Transient and Burst Immunity	AC Port: L, N, L-N ±2kV	IEC/EN61000-4-4:2012, Criteria A
Surge Immunity	AC Port L-N: ±0.5, 1, 2kV L-PE, N-PE: ±0.5, 1, 2, 4kV	IEC/EN61000-4-5:2014, Criteria B
Immunity to conducted disturbances, induced by radio-frequency fields	AC Port: 3Vrms (0.15-80MHz) 6Vrms (IMS Band)	IEC61000-4-6:2013, Criteria A EN61000-4-6:2014, Criteria A
Power Magnetic Field Immunity	30A/m	IEC61000-4-8:2009, Criteria A EN61000-4-8:2010, Criteria A
Voltage Dips and Interruptions	Voltage Dips 30% Voltage Dips 100% (0.5P) Voltage Dips 100% (1.0P) Voltage Interruptions 100%	IEC/EN61004-11:2004, Criteria A IEC/EN61004-11:2004, Criteria A IEC/EN61004-11:2004, Criteria A IEC/EN61004-11:2004, Criteria B

continued on next page

Specifications (measured @ Ta= 25°C, nom. Vin, full load and after warm-up unless otherwise stated)

EMC Compliance (Industrial)	Condition	Standard / Criterion
Electromagnetic compatibility of multimedia equipment – Emission Requirements	LCS200616044BE	EN55032:2015
Electromagnetic compatibility of multimedia equipment – Immunity requirements		EN55035:2017
ESD Electrostatic discharge immunity test	Air ±2, 4, 8kV; Contact ±2, 8kV	IEC61000-4-2:2008 , Criteria A EN61000-4-2:2009, Criteria A
Radiated, radio-frequency, electromagnetic field immunity test	3V/m (4800-1000MHz, 1800, 2600, 3500, 5000MHz)	IEC/EN61000-4-3:2006 + A2:2010, Criteria A
Fast Transient and Burst Immunity	AC Port: L, N, L-N ±1kV	IEC/EN61000-4-4:2012, Criteria B
Surge Immunity	AC Port: L-N: ±1kV	IEC/EN61000-4-5:2014, Criteria B
Immunity to conducted disturbances, induced by radio-frequency fields	AC Port: 3Vrms (0.15-80MHz) 3Vrms (10-30MHz) 1Vrms (30-80MHz)	IEC61000-4-6:2013, Criteria A EN61000-4-6:2014, Criteria A
Power Magnetic Field Immunity	1A/m	IEC61000-4-8:2009, Criteria A EN61000-4-8:2010, Criteria A
Voltage Dips and Interruptions	Voltage Dips 30% Voltage Dips 100% Voltage Interruptions 100%	IEC/EN61004-11:2004, Criteria C IEC/EN61004-11:2004, Criteria B IEC/EN61004-11:2004, Criteria C
EMC Compliance (Low voltage power supply)		
Low voltage power supplies, d.c. output Part 3: Electromagnetic compatibility (EMC)	LCS200616049BE	IEC/EN61204-3:2018
ESD Electrostatic discharge immunity test	Air ±2, 4, 8kV; Contact ±2, 8kV	IEC61000-4-2:2008 , Criteria A EN61000-4-2:2009, Criteria A
Radiated, radio-frequency, electromagnetic field immunity test	10V/m (80-1000MHz) 3V/m (1400-2000MHz) 1V/m (2000-2700MHz)	IEC/EN61000-4-3:2006 + A2:2010, Criteria A
Fast Transient and Burst Immunity	AC Port: L, N, L-N ±2kV	IEC/EN61000-4-4:2012, Criteria B
Surge Immunity	AC Port: L-N: ±1kV	IEC/EN61000-4-5:2014, Criteria B
Immunity to conducted disturbances, induced by radio-frequency fields	AC Port: 10Vrms (0.15-80MHz)	IEC61000-4-6:2013, Criteria A EN61000-4-6:2014, Criteria A
Power Magnetic Field Immunity	30A/m	IEC61000-4-8:2009, Criteria A EN61000-4-8:2010, Criteria A
Voltage Dips and Interruptions	Voltage Dips 20, 30,60% Voltage Dips 100% (0.5P) Voltage Dips 100% (1.0P) Voltage Interruptions 100%	IEC/EN61004-11:2004, Criteria C IEC/EN61004-11:2004, Criteria B IEC/EN61004-11:2004, Criteria B IEC/EN61004-11:2004, Criteria C
Limits of Voltage Fluctuations & Flicker		EN61000-3-3:2013
Limitations on the amount of electromagnetic interference allowed from digital and electronic devices		FCC 47 CFR Part 15 Subpart B, Class B
Limitations on the amount of electromagnetic interference allowed from digital and electronic devices, industrial, scientific, and medical equipment		FCC 47 CFR Part 18

DIMENSION AND PHYSICAL CHARACTERISTICS

Parameter	Type	Value
Material	PCB	FR4, (UL94 V-0)
	potting	PU, (UL94 V-0)
	baseplate	plastic, (UL94V-0)
Dimension (LxWxH)		83.23 x 46.43 x 30.40mm
Weight		185g typ.

continued on next page

Specifications (measured @ Ta= 25°C, nom. Vin, full load and after warm-up unless otherwise stated)

Dimension Drawing (mm)

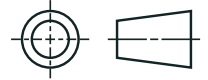
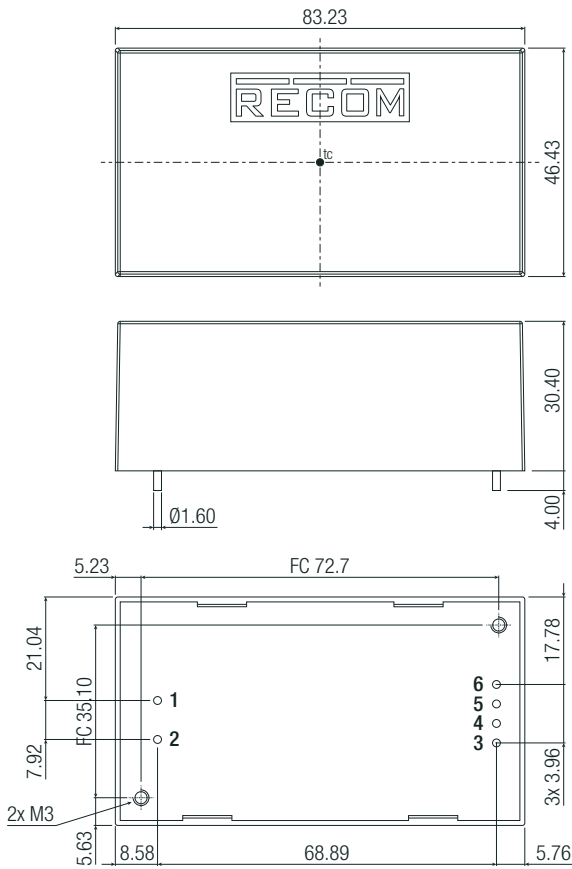

General tolerances according to ISO 2768-m (table for reference only)	
Dimension range	Tolerances
0.5 - 6 mm	±0.1 mm
6 - 30 mm	±0.2 mm
30 - 120 mm	±0.3 mm
120 - 400 mm	±0.5 mm

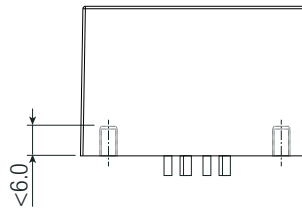

Recommend Footprint Details

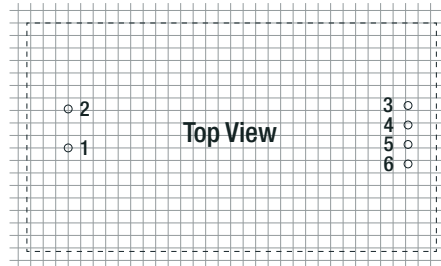

Pinning information

Pin #	Function
1	VAC in (N)
2	VAC in (L)
3	-Vout
4	-Vout
5	+Vout
6	+Vout

FC= fixing centers
tc=

Blockdiagram

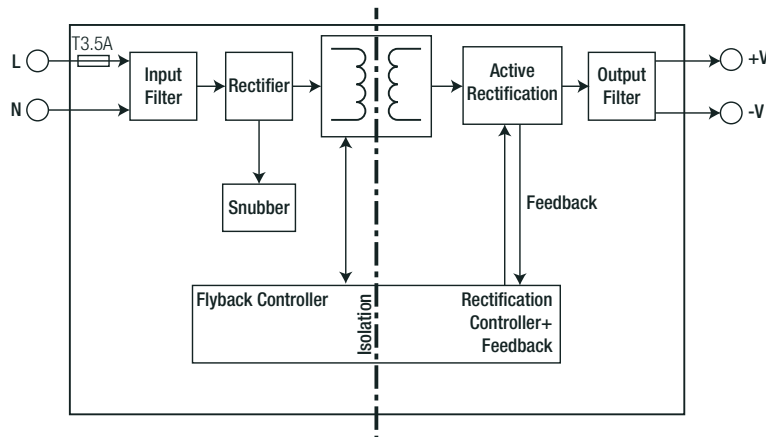

PACKAGING INFORMATION

Parameter	Type	Value
Packaging Dimension (LxWxH)	tray	365.0 x 210.0 x 56.0mm
Packaging Quantity		12pcs
Storage Temperature Range		-40°C to +90°C
Storage Humidity	non-condensing	95% max.

The product information and specifications may be subject to changes even without prior written notice. The product has been designed for various applications; its suitability lies in the responsibility of each customer. The products are not authorized for use in safety-critical applications without RECOM's explicit written consent. A safety-critical application is an application where a failure may reasonably be expected to endanger or cause loss of life, inflict bodily harm or damage property. The applicant shall indemnify and hold harmless RECOM, its affiliated companies and its representatives against any damage claims in connection with the unauthorized use of RECOM products in such safety-critical applications.