

NFC Type 5 / RFID tag IC with up to 2.5 Kbits of EEPROM, product identification and protection

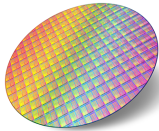

UDFPN5
1.7 x 1.4 mm



Wafer



Product status link
ST25TV02KC
ST25TV512C

Features

Contactless interface

- Compliant with ISO/IEC 15693
- NFC Forum Type 5 tag certified by the NFC Forum
- Supports all ISO/IEC 15693 modulations, coding, subcarrier modes, and datarates up to 26 Kbit/s
- Single block reads and writes, multiple block reads
- Internal tuning capacitance: 23 pF

Memory

- Up to 2560 bits (320 bytes) of EEPROM
- Accessible by blocks of four bytes
- Write time from RF: typical 5 ms per block
- Data retention: 60 years at 55°C
- Minimum endurance: 100k write cycles
- 3-digit unique tap code
- Augmented NDEF (contextual automatic NDEF message)

Data protection

- User memory configurable in one or two areas:
 - in single area mode, access protectable by one 64-bit password
 - in flexible dual area mode, access protectable by two 32-bit passwords
- System configuration: access protected by a 32-bit password
- Permanent write lock of specific user area blocks
- Temporary write lock at user area level
- Permanent write lock of specific system configuration blocks

Product identification and protection

- Password features: cover coding, recovery, failed attempt counter
- Tamper detection capability with memorization of open/resealed events
- TruST25™ digital signature

Privacy

- Configurable kill mode for permanent deactivation of the tag
- Untraceable mode with configurable responsiveness

Temperature range

- From - 40 to 85 °C

Package

- 5-pin package, ECOPACK2® (RoHS compliant)
- Bumped and sawn wafer

1 Description

The **ST25TV02KC** and **ST25TV512C** devices are NFC/RFID tag ICs with an Augmented NDEF feature, a tamper detection interface, and specific modes to protect customer privacy.

The Augmented NDEF feature is a contextual automatic NDEF message service, allowing the tag to respond dynamic content without an explicit update of the EEPROM by the enduser.

The tamper detection interface is available on ST25TV02KC-T devices only. This interface is not available on ST25TV02KC-A and ST25TV512C devices.

The ST25TV02KC and ST25TV512C devices hold a digital signature generated by TruST25™ (a set of software and procedures) to prove the origin of the chip in cloning detection, embeds a configurable EEPROM with 60-year data retention, and can be operated from a 13.56 MHz long range RFID reader or an NFC phone.

The contactless interface is compliant with the ISO/IEC 15693 standard and NFC Forum Type 5 tag specification.

1.1 Block diagram

The ST25TV02KC and ST25TV512C (hereinafter referred to as ST25TVxxxC) devices are depicted in the following block diagram:

Figure 1. ST25TVxxxC block diagram

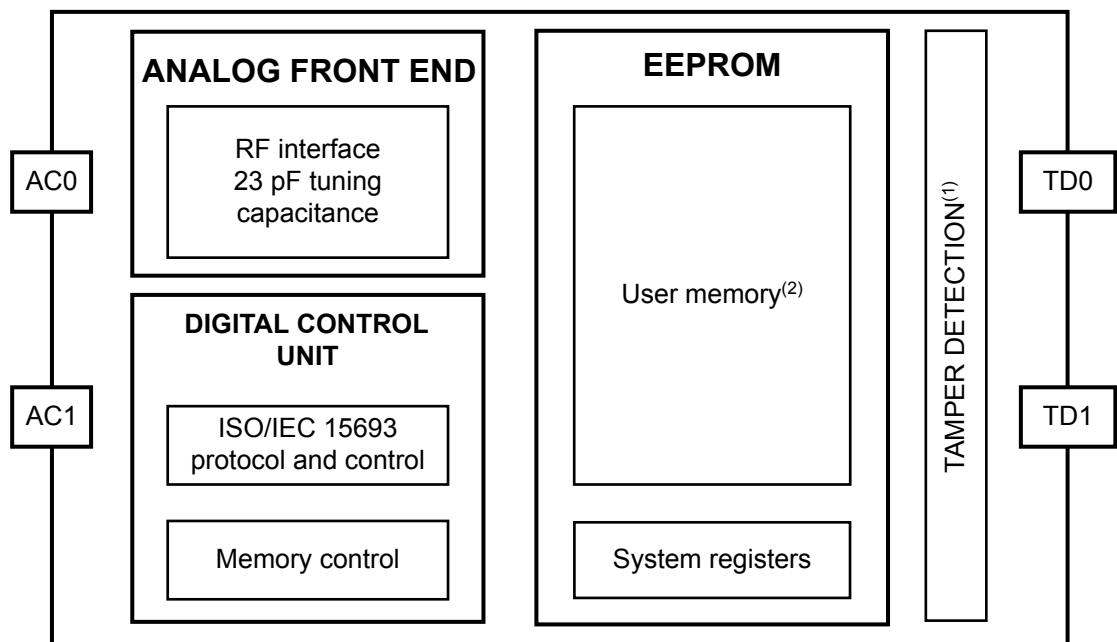

1. The tamper detection interface is available on ST25TV02KC-T devices only.
2. Respectively 512 and 2560 bits on ST25TV512C and ST25TV02KC devices.

1.2 Package connections

ST25TV02KC and **ST25TV512C** are provided in two delivery forms:

- UDFPN5 package (ST25TV02KC-T devices only)
- Sawn and bumped wafer (ST25TV512C, ST25TV02KC-A and ST25TV02KC-T devices)

Table 1. Signal names

Signal name	Function	Direction
AC0	Antenna coils	In-out
AC1	Antenna coils	In-out
TD0	Tamper detection loop	In
TD1	Tamper detection loop	Out

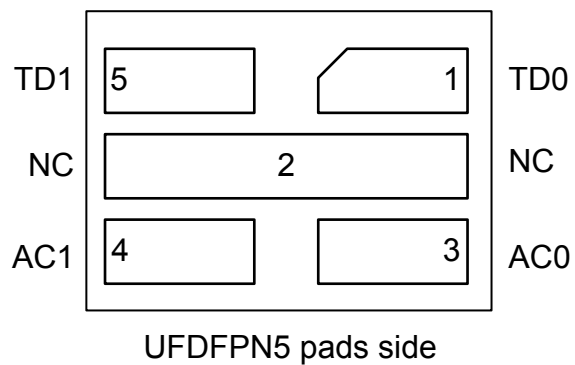
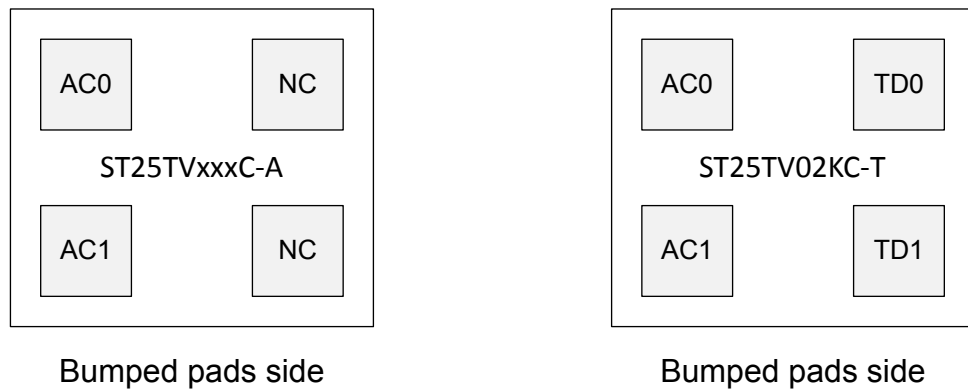
Figure 2. UDFPN5 package connections

Figure 3. Die connections for sawn and bumped wafer

2 Signal descriptions

2.1 Antenna coil (AC0, AC1)

These inputs are used to connect the ST25TVxxxC device to an external coil exclusively. It is advised not to connect any other DC or AC path to AC0 or AC1.

When correctly tuned, the coil is used to power and access the device using the ISO/IEC 15693 and ISO 18000-3 mode 1 protocols.

2.2 Tamper detection (TD0, TD1)

These inputs are used to connect a wire loop to the ST25TVxxxC device to detect an open or a short between the TD0 and TD1 pins.

3 Power management

The ST25TVxxxC device is powered through its contactless interface.

3.1 Device set

To ensure a proper boot of the RF circuitry, the RF field must be turned ON without any modulation for a minimum period of time t_{BOOT_RF} (see Table 172. RF characteristics). During t_{BOOT_RF} , the ST25TVxxxC ignores all received RF commands (see Figure 4).

Figure 4. RF power-up sequence

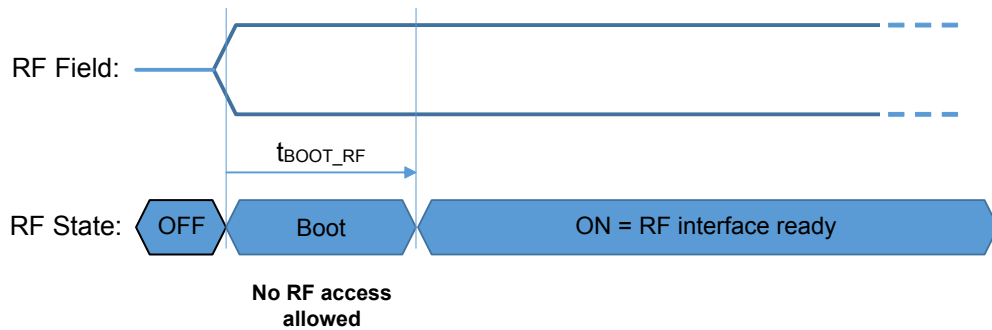

3.2 Device reset

To ensure a proper reset of the RF circuitry, the RF field must be turned off (100% modulation) for a minimum t_{RF_OFF} amount of time (see Table 172. RF characteristics).

4 Memory management

4.1 Memory organization

The ST25TVxxxC memory is organized as follows:

- User memory: it can be configured in one or two different areas, as described in [Section 4.2 User memory](#). Those areas can be used for user data and NFC Forum Type 5 Capability Container (CC) if required.
- System configuration memory: it is composed of different registers, including the device configuration, the ISO15693 AFI and DSFID registers. It also contains the UID and different protection registers. Refer to [Section 4.3 System configuration memory](#) for more details

Figure 5. Memory organization

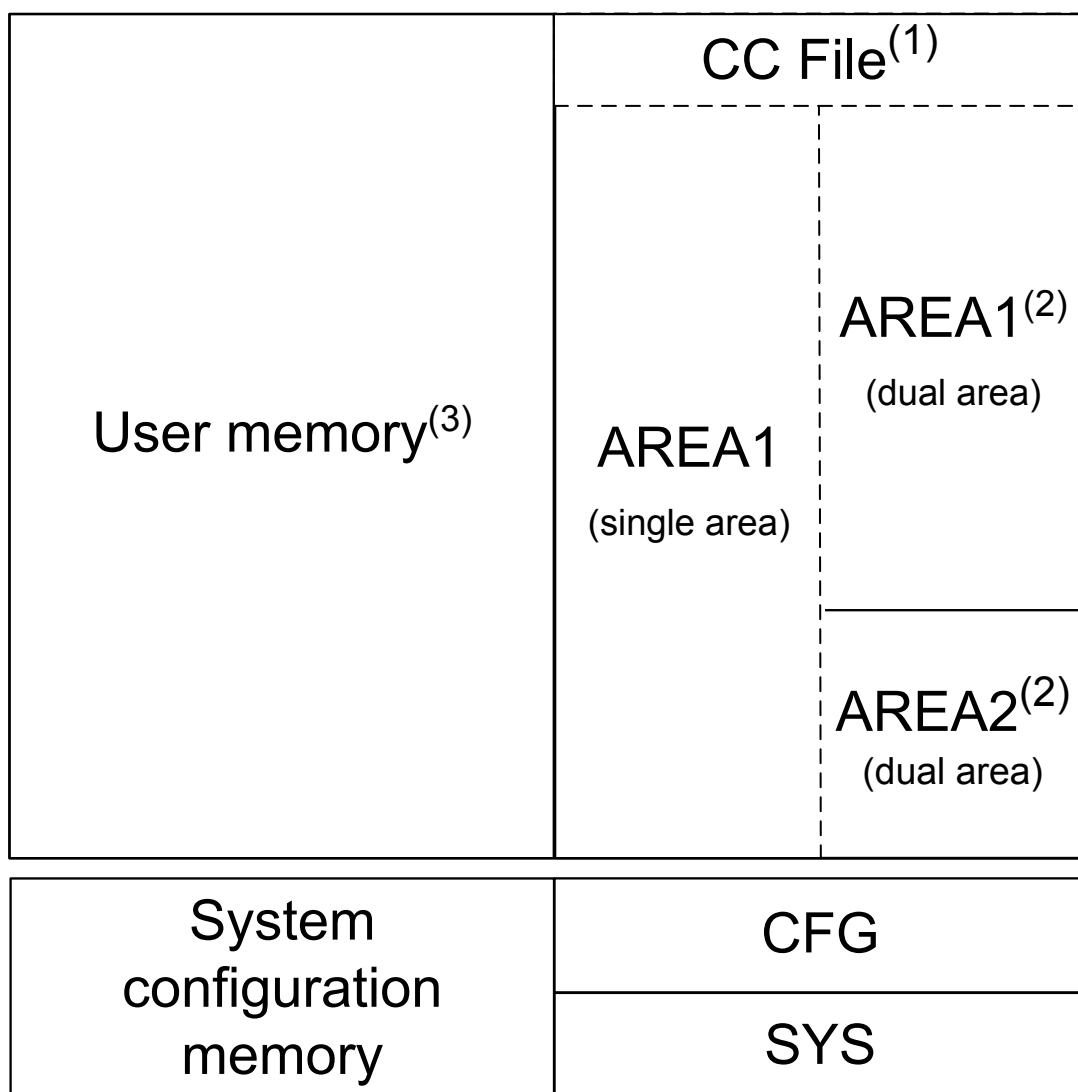

1. NFC Forum T5T CC file is coded on block 00h which is part of AREA1.
2. In dual area mode, the AREA1/AREA2 boundary can be configured with a block granularity.
3. Respectively 16 and 80 blocks of 32 bits for ST25TV512C and ST25TV02KC devices.

4.2 User memory

User memory is addressed as blocks (= pages) of 4 bytes, starting at address 0 and ending at address END_MEM. Value of END_MEM is 0Fh and 4Fh for ST25TV512C and ST25TV02KC devices respectively. The ST25TVxxxC user memory can be configured in single area (AREA1) or in dual area mode (AREA1 and AREA2) depending on the value of the END_A1 register at the start of a RF session (see [Table 2. User memory in single area mode](#), [Table 3. User memory in dual area mode](#) and [Table 13. END_A1 content](#)).

When the value of END_A1 is equal to END_MEM, the ST25TVxxxC user memory is configured in single area mode defined as follows:

- AREA1 starts at address 00h. It is composed of (END_MEM+1) blocks. It can be read- or readwrite-protected by a dedicated 64-bit password. AREA1 is dedicated to user data.

When the value of END_A1 is lower than END_MEM, the ST25TVxxxC user memory is configured in dual area mode defined as follows :

- AREA1 starts at address 00h. It is composed of (END_A1+1) blocks. It can be read- or readwrite-protected by a dedicated 32-bit password. AREA1 is dedicated to user data.
- AREA2 starts at address (END_A1+1). It is composed of (END_MEM-END_A1) blocks. It can be read- or readwrite-protected by a dedicated 32-bit password. AREA2 is dedicated to user data.

Block 00h belongs to AREA1, but can always be read regardless of the read-protection mode of AREA1. This block is dedicated to the CC file content defined by the NFC Forum Type 5 application. An application that does not need to comply with NFC Forum Type 5 specifications can use block 00h for any purpose.

Table 2. User memory in single area mode

RF command	Block address	Byte address				Comment
		LSByte	-	-	MSByte	
ReadSingleBlock ReadMultipleBlocks WriteSingleBlock	00h ⁽¹⁾	0000h	0001h	0002h	0003h	AREA1 ⁽²⁾
	01h	0004h	0005h	0006h	0007h	
	02h	0008h	0009h	000Ah	000Bh	
	
	END_MEM	END_MEM*4+0	END_MEM*4+1	END_MEM*4+2	END_MEM*4+3	

1. Block 00h is always readable

2. For single area mode, set the value of END_A1 register to END_MEM

Table 3. User memory in dual area mode

RF command	Block address	Byte address				Comment
		LSByte	-	-	MSByte	
ReadSingleBlock ReadMultipleBlocks WriteSingleBlock	00h ⁽¹⁾	0000h	0001h	0002h	0003h	AREA1 ⁽²⁾
	01h	0004h	0005h	0006h	0007h	
	02h	0008h	0009h	000Ah	000Bh	
	
	END_A1	END_A1*4+0	END_A1*4+1	END_A1*4+2	END_A1*4+3	AREA2 ⁽²⁾
	END_A1+1	END_A1*4+4	END_A1*4+5	END_A1*4+6	END_A1*4+7	
	
	END_MEM	END_MEM*4+0	END_MEM*4+1	END_MEM*4+2	END_MEM*4+3	

1. Block 00h is always readable

2. For dual area mode, set value of END_A1 register between 00h and (END_MEM-1)

4.3 System configuration memory

In addition to user memory, ST25TVxxxC includes a set of registers located in the system configuration memory. Registers are read during the boot sequence and define basic ST25TVxxxC behaviour.

4.3.1 System configuration registers

Table 4. List of configuration registers lists the configuration registers of the ST25TVxxxC device. They are accessed with the ReadConfiguration and WriteConfiguration commands and two arguments FID and PID, respectively acting as a feature identifier and a parameter identifier.

The write access to the configuration registers is protected by the CONFIG security session which is opened by a successful presentation of the PWD_CFG password (see Section 5.1.2 Password management).

Configuration registers are grouped by FID value. The write access to a group of registers may be permanently locked.

Depending on the configuration register, its read access is either always granted or protected with the same mechanisms as its write access.

Depending on the configuration register, when its content is updated during a RF session, the effect of the new value is activated either immediately or at the start of the next RF session.

Table 4. List of configuration registers

Name	FID	PID	Bytes	Read ⁽¹⁾	Write ⁽²⁾	Activation time ⁽³⁾	Section
RW_PROTECTION_A1	00h	00h	1	Y	W	B	Section 5.1.1
END_A1	00h	01h	1	Y	W'	B	Section 5.1.1
RW_PROTECTION_A2	01h	00h	1	Y	W	B	Section 5.1.1
UTC_EN	02h	00h	1	Y	W	B	Section 5.2.1
UTC	02h	01h	3	Y	N	-	Section 5.2.1
TD_EVENT_UPDATE_EN ⁽⁴⁾	03h	00h	1	Y	W	B	Section 5.3.1
TD_SEAL_MSG ⁽⁴⁾	03h	01h	2	R	W	I	Section 5.3.1
TD_UNSEAL_MSG ⁽⁴⁾	03h	02h	2	R	W	I	Section 5.3.1
TD_RESEAL_MSG ⁽⁴⁾	03h	03h	2	R	W	I	Section 5.3.1
TD_SHORT_MSG ⁽⁴⁾	03h	04h	1	R	W	I	Section 5.3.1
TD_OPEN_MSG ⁽⁴⁾	03h	05h	1	R	W	I	Section 5.3.1
TD_STATUS ⁽⁴⁾	03h	06h	3	Y	N	-	Section 5.3.1
ANDEF_EN	04h	00h	1	Y	W	B	Section 5.4.1
ANDEF_CFG	04h	01h	2	Y	W	B	Section 5.4.1
ANDEF_SEP	04h	02h	1	R	W	I	Section 5.4.1
ANDEF_CUSTOM_LSB	04h	03h	4	R	W	I	Section 5.4.1
ANDEF_CUSTOM_MSB	04h	04h	4	R	W	I	Section 5.4.1
PRIVACY	05h	00h	1	Y	W	B	Section 5.5.1
AFI_PROT	08h	00h	1	Y	W	B	Section 5.7.1
REV	FEh	00h	1	Y	N	-	Section 5.9
UID	FEh	01h	8	Y	N	-	Section 5.9
LCK_CONFIG	FFh	00h	2	Y	W''	I	Section 5.1.1

1. Y: read access not protected, R: read access granted if LCK_CONFIG[FID]=0b and CONFIG security session open

2. N: write access not available, W: write access granted if LCK_CONFIG[FID]=0b and CONFIG security session open, W': write access granted if LCK_CONFIG[1:0]=00b and CONFIG security session open, W'': write access granted if CONFIG security session open

3. B: update is effective on next RF boot sequence, I: update is effective immediately

4. Registers with FID=03h are available only on ST25TV02KC-T devices (see section 10)

4.3.2 System registers

Table 5 lists the system registers of the ST25TVxxxC device. They are accessed with other RF commands than ReadConfiguration and WriteConfiguration.

When the write access to a system register is available, it may be protected by a password and/or a lock mechanism.

When the read access to a system register is available, it is always granted through the relevant RF command.

When the content of a system register is updated, the effect of the new value is activated immediately.

Table 5. List of system registers

Name	Bytes	Read ⁽¹⁾	Write ⁽²⁾	Activation time	Section
LCK_BLOCK	10	R	W	I	Section 5.1.1
LCK_DSFD	1	N	W	I	Section 5.9
LCK_AFI	1	N	W	I	Section 5.9
DSFD	1	Y	W	I	Section 5.9
AFI	1	Y	W	I	Section 5.9
IC_REF	1	Y	N	-	Section 5.9
UID	8	Y	N	-	Section 5.9
ANDEF_UID	16	Y	N	-	Section 5.4.1
KILL_CMD	1	N	W	I	Section 5.5.1
UNTR_CMD	1	N	W	I	Section 5.5.1
RND_NUMBER	2	Y	N ⁽³⁾	-	Section 5.1.1
PWD_CFG	4	N	W	I	Section 5.1.1
PWD_A1	4	N	W	I	Section 5.1.1
PWD_A2	4	N	W	I	Section 5.1.1
PWD_UNTR	4	N	W	I	Section 5.1.1

1. Y: read access granted without condition, R: read access granted with condition

2. N: write access not available, W: write access granted with condition

3. The content of the RND_NUMBER register is updated internally on a successful GetRandomNumber request

5 Specific features

ST25TVxxxC offers the following features:

- [Section 5.1 Data protection](#)
- [Section 5.2 Unique tap code](#)
- [Section 5.3 Tamper detection](#)
- [Section 5.4 Augmented NDEF](#)
- [Section 5.5 Consumer privacy protection](#)
- [Section 5.6 TruST25™ digital signature](#)
- [Section 5.7 AFI protection](#)
- [Section 5.8 Inventory Initiated](#)

The features from [Section 5.1](#) to [Section 5.7](#) can be programmed by accessing registers of the ST25TVxxxC using the ReadConfiguration and WriteConfiguration commands. Update of configuration registers is only possible when the access right has been granted by presenting the configuration password (PWD_CFG), and if the configuration of the feature was not previously locked (see register LCK_CONFIG).

Depending on the configuration register, the effect of a valid write access may be applied immediately or during the boot sequence of the next RF session.

An additional set of registers allows to identify and customize the product (see [Section 5.9 Device identification registers](#)).

5.1 Data protection

ST25TVxxxC provides a special data protection mechanism based on passwords that unlock security sessions.

Read and/or write access to the user memory can be protected. Write access to the configuration registers is always protected. Read access to some configuration registers is protected.

Other lock mechanisms are supported (LockBlock, lock by feature), as described in this section.

5.1.1 Data protection registers

Table 6. LCK_CONFIG access

RF Command	Access type
ReadConfiguration @(FID=FFh, PID=00h)	R : always possible
WriteConfiguration @(FID=FFh, PID=00h)	W : if the CONFIG security session is open
	W effective time : immediate

Table 7. LCK_CONFIG content

Bit	Name	Function	Factory value
b0	LCK_A1	0: configuration registers with FID=00h are not locked 1: configuration registers with FID=00h are locked	0b
b1	LCK_A2	0: configuration registers with FID=01h are not locked 1: configuration registers with FID=01h are locked	0b
b2	LCK_UTC	0: configuration registers with FID=02h are not locked 1: configuration registers with FID=02h are locked	0b
b3	LCK_TD	0: configuration registers with FID=03h are not locked 1: configuration registers with FID=03h are locked	0b
b4	LCK_ANDEF	0: configuration registers with FID=04h are not locked 1: configuration registers with FID=04h are locked	0b
b5	LCK_PRIV	0: configuration registers with FID=05h are not locked 1: configuration registers with FID=05h are locked	0b
b7-b6	RFU	-	00b
b8	LCK_AFIP	0: configuration registers with FID=08h are not locked 1: configuration registers with FID=08h are locked	0b
b15-b9	RFU	-	0000000b

Note: Refer to [Table 4. List of configuration registers for the LCK_CONFIG register.](#)

If value 1b is issued for a field already set to 1b, the WriteConfiguration command has no effect and error 11h shall be responded.

Otherwise, if value 0b is issued for a field set to 1b, the corresponding feature remains locked and no errorcode is responded to the WriteConfiguration command.

Table 8. LCK_BLOCK access

RF Command	Access type
ReadSingleBlock	R : if Option_flag=1 and write access to parent area is allowed ⁽¹⁾
ReadMultipleBlocks	R : if Option_flag=1 and write access to parent area is allowed ⁽¹⁾
GetMultipleBlockSecurityStatus	R : if write access to parent area is allowed ⁽¹⁾
LockBlock	W : if not already locked and write access to parent area is allowed
-	W effective time : immediate

1. When the write access to an area is not allowed (write access forbidden, or protected with closed security session), then the value of LCK_BLOCK is masked by 1 in a BSS field (see sections [Section 6.4.3 ReadSingleBlock](#), [Section 6.4.6 ReadMultipleBlocks](#) and [Section 6.4.14 GetMultipleBlockSecurityStatus](#))

Table 9. LCK_BLOCK content

Bit	Name	Function	Factory Value
b79-b0	LCK_BLOCK	For each bit b _N : <ul style="list-style-type: none"> • 0: write access of block N not locked • 1: write access of block N permanently 	0

Note: Refer to [Table 5. List of system registers for the LCK_BLOCK register.](#)

Table 10. RW_PROTECTION_A1 access

RF Command	Type
ReadConfiguration @(FID=00h, PID=00h)	R : always possible
WriteConfiguration @(FID=00h, PID=00h)	W : if the CONFIG security session is open and LCK_A1=0b
	W effective time : on next RF boot sequence

Table 11. RW_PROTECTION_A1 content

Bit	Name	Function	Factory Value
b1-b0	RW_PROTECTION_A1	AREA1 access rights (except block 00h): <ul style="list-style-type: none"> 00: read always allowed / write always allowed 01: read always allowed / write allowed if AREA1 security session is open 10: read allowed if AREA1 security session is open / write allowed if AREA1 security session is open 11: read allowed if AREA1 security session is open / write forbidden Block 00h access rights: read always allowed <ul style="list-style-type: none"> 00: write always allowed 01: write allowed if AREA1 security session is open 10: write allowed if AREA1 security session is open 11: write forbidden 	00b
b7-b2	RFU	-	000000b

Note: Refer to Table 4. List of configuration registers for the RW_PROTECTION_A1 register.

Table 12. END_A1 access

RF command	Access type
ReadConfiguration @(FID=00h, PID=01h)	R : always possible
WriteConfiguration @(FID=00h, PID=01h)	W : if the CONFIG security session is open and LCK_A1=LCK_A2=0b
	W effective time : on next RF boot sequence

Table 13. END_A1 content

Bit	Name	Function	Factory Value
b7-b0	END_A1	Number of the last block belonging to AREA1. When lower than END_MEM, user memory is split in two areas : <ul style="list-style-type: none"> AREA1 (blocks 00h to END_A1) AREA2 (blocks END_A1 + 1 to END_MEM). Otherwise user memory contains a single area : AREA1 (blocks 00h to END_MEM)	END_MEM ⁽¹⁾

1. END_MEM value is 0Fh / 4Fh for ST25TV512C / ST25TV02KC devices respectively.

Note: Refer to Table 4. List of configuration registers for the END_A1 register.

Table 14. RW_PROTECTION_A2 access

RF command	Access type
ReadConfiguration @(FID=01h, PID=00h)	R : always possible
WriteConfiguration @(FID=01h, PID=00h)	W : if the CONFIG security session is open and LCK_A2=0b
	W effective time : on next RF boot sequence

Table 15. RW_PROTECTION_A2 content

Bit	Name	Function	Factory Value
b1-b0	RW_PROTECTION_A2	AREA2 access rights: <ul style="list-style-type: none"> • 00: read always allowed / write always allowed • 01: read always allowed / write allowed if AREA2 security session is open • 10: read allowed if AREA2 security session is open / write allowed if AREA2 security session is open • 11: read allowed if AREA2 security session is open / write not allowed 	00b
b7-b2	RFU	-	000000b

Note: Refer to [Table 4. List of configuration registers for the RW_PROTECTION_A2 register.](#)

Table 16. PWD_CFG access

RF command	Access type
-	R: no read access
WritePassword @PID=00h	W: if the CONFIG security session is open
	W effective time: immediate

Table 17. PWD_CFG content

Bit	Name	Function	Factory Value
b31-b0	PWD_CFG	Password for access to configuration registers and Kill command	00000000h

Note: Refer to [Table 5. List of system registers for the PWD_CFG register.](#)

Table 18. PWD_A1 access

RF command	Access type
-	R : no read access
WritePassword @PID=01h	W : if AREA1 security session is open
	W effective time : immediate

Table 19. PWD_A1 content

Bit	Name	Function	Factory Value
b31-b0	PWD_A1_LSB	Password for access to AREA1	00000000h
b63-b32	PWD_A1_MSB ⁽¹⁾	In single area mode, bits 0 to 63 are used.	00000000h
		In dual area mode only bits 0 to 31 are used	

1. *PWD_A1_MSB* is an alias of register *PWD_A2*:

- when switching from dual to single area mode, the value of *PWD_A1_MSB* is the latest known value of *PWD_A2*
- when switching from single to dual area mode, the value of *PWD_A2* is the latest known value of *PWD_A1_MSB*

Note: Refer to [Table 5. List of system registers for the PWD_A1 register.](#)

Table 20. PWD_A2 access

RF command	Access type
-	R : no read access
WritePassword @PID=02h	W : if AREA2 security session is open
	W effective time : immediate

Table 21. PWD_A2 content

Bit	Name	Function	Factory Value
b31-b0	PWD_A2 ⁽¹⁾	Password for access to AREA2	00000000h

1. *PWD_A1_MSB* is an alias of register *PWD_A2*:

- when switching from dual to single area mode, the value of *PWD_A1_MSB* is the latest known value of *PWD_A2*
- when switching from single to dual area mode, the value of *PWD_A2* is the latest known value of *PWD_A1_MSB*

Note: Refer to [Table 5. List of system registers for the PWD_A2 register.](#)

Table 22. PWD_UNTR access

RF command	Access type
-	R : no read access
WritePassword @PID=03h	W : if UNTR security session is open
	W effective time : immediate

Table 23. PWD_UNTR content

Bit	Name	Function	Factory Value
b31-b0	PWD_UNTR	Password used with ToggleUntraceable command	00000000h

Note: Refer to [Table 5. List of system registers for the PWD_UNTR register.](#)

Table 24. RND_NUMBER access

RF command	Access type
GetRandomNumber	R : always possible
-	W : no write access ⁽¹⁾

1. the content of the RND_NUMBER register is updated internally on a successful GetRandomNumber command.

Table 25. RND_NUMBER content

Bit	Name	Function	Factory value
b15-b0	RND_NUMBER	16-bit random number	N/A

Note: Refer to [Table 5. List of system registers](#) for the RND_NUMBER register.

5.1.2 Password management

ST25TVxxxC provides protection of user and system configuration memories. Access to groups of data are controlled by security sessions based on passwords. On successful (respectively failed) presentation of a password, a security session is open (respectively closed) and grants (respectively denies) access to the protected group of data.

Table 26. Security session type

Security session	Open by presenting	Rights granted when session is open
CONFIG	PWD_CFG	Access to configuration registers Update of PWD_CFG
AREA1	PWD_A1	Access to blocks from AREA1 in user memory Update of PWD_A1
AREA2	PWD_A2	Access to blocks from AREA2 in user memory Update of PWD_A2
UNTR	PWD_UNTR	Update of PWD_UNTR

Each of the PWD_CFG and PWD_UNTR passwords is 32-bit long.

In dual area mode (END_A1 < END_MEM), each of the PWD_A1 and PWD_A2 passwords is 32-bit long.

In single area mode (END_A1 = END_MEM), the PWD_A1 password is 64-bit long, and AREA2 security session is not applicable: password commands fail with password identifier 02h when single area mode is used.

Note: In addition to the security session mechanism described in this section, the PWD_CFG and PWD_UNTR passwords are respectively used with the Kill and ToggleUntraceable commands.

Table 27. List of password registers

Password	Password_id	Password_data size
PWD_CFG	00h	4 bytes
PWD_A1	01h	4 bytes if END_A1 < END_MEM
		8 bytes if END_A1 = END_MEM
PWD_A2	02h	4 bytes if END_A1 < END_MEM
		Invalid request if END_A1 = END_MEM
PWD_UNTR	03h	4 bytes

The ST25TVxxxC passwords management is based on three commands:

- WritePassword (see [Section 6.4.18 WritePassword](#))
- PresentPassword (see [Section 6.4.19 PresentPassword](#))
- GetRandomNumber (see [Section 6.4.24 GetRandomNumber](#))

For any of the 4x passwords available, three actions are possible:

- **Open Security Session:**
 - Use GetRandomNumber command if needed
 - Use PresentPassword command with corresponding password identifier and valid encrypted password value (see [Section 5.1.4 User memory protection](#))
- **Update Password:**
 - While the security session for the corresponding password is open, use WritePassword command with same password identifier and the new encrypted password value (see [Section 5.1.4 User memory protection](#)).
- **Close Security Session:**
 - To close the security session corresponding to a password identifier, user can choose one of the following options:
 - Remove tag from RF field
 - Use PresentPassword command with same password identifier and an invalid password value
 - Open a security session corresponding to a different password identifier. Opening a new security session automatically closes the previously opened one (even if the open operation fails)

Figure 6 describes the mechanism to open/close the security sessions.

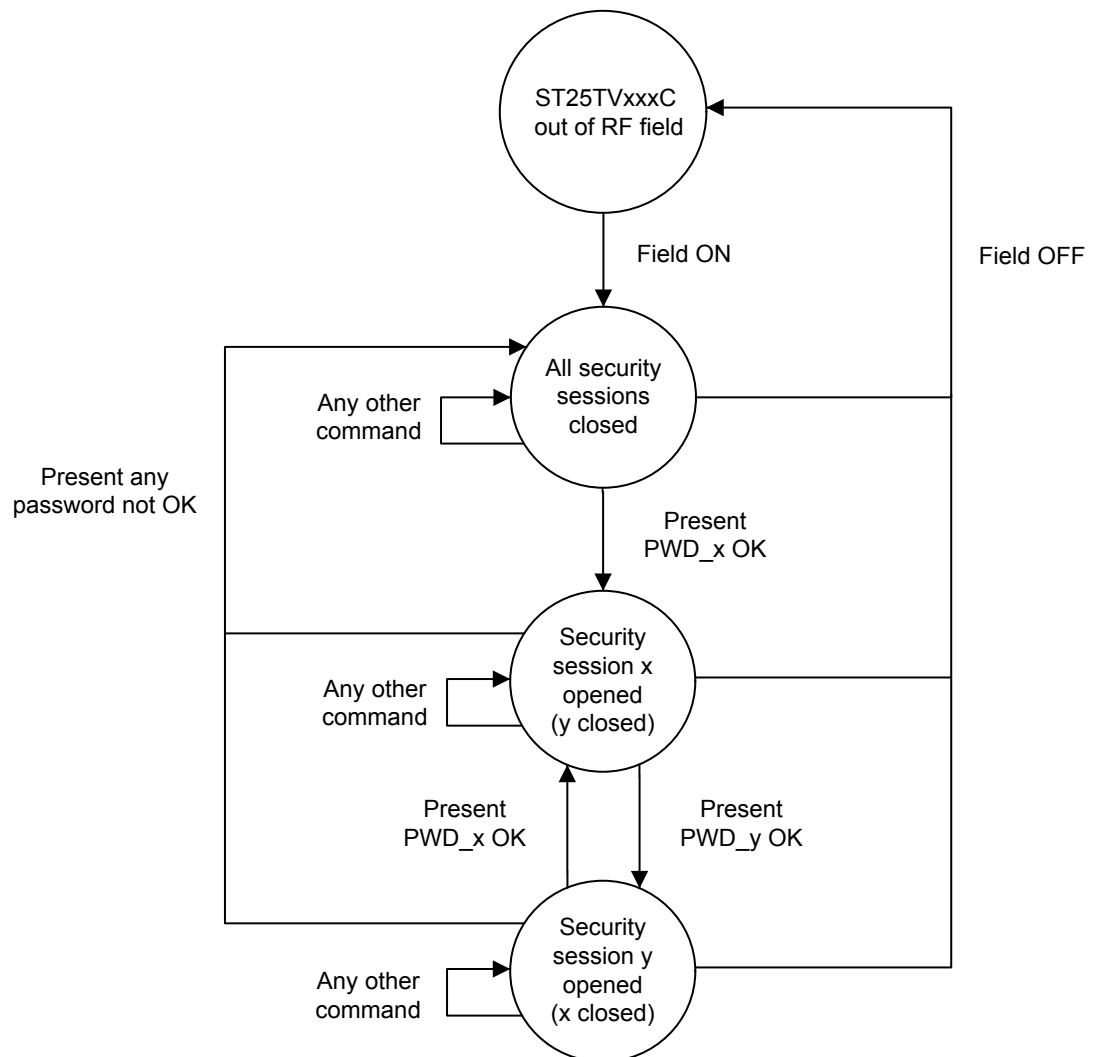
Figure 6. Security sessions management

Password recovery

The ST25TVxxxC devices provide a password recovery feature, which allows the user to reprogram a corrupted password after a RF field failure during a WritePassword command.

Refer to “AN5577 - Password management for ST25TV512C and ST25TV02KC devices”, for more details on how to use it. Contact your STMicroelectronics sales office to get this document.

Password attempt limit

The ST25TVxxxC devices offer the capability to protect a password against brute-force attacks, thanks to a limiter mechanism on failed password attempts.

Refer to “AN5577 - Password management for ST25TV512C and ST25TV02KC devices”, for more details on how to use it. Contact your STMicroelectronics sales office to get this document.

5.1.3 Password encryption

An encryption mechanism - known as cover coding - is used to transmit coded password values in the Password_data field of the following command frames:

- PresentPassword request (see Section 6.4.19 PresentPassword),
- WritePassword request (see Section 6.4.18 WritePassword)
- Kill request (see Section 6.4.20 Kill)
- ToggleUntraceable request (see Section 6.4.23 ToggleUntraceable)

The mechanism requires that a call to the GetRandomNumber command has been issued since the latest boot of the ST25TVxxxC device, otherwise these password commands fail.

Additionally, if the latest call to a PresentPassword / Kill / ToggleUntraceable command failed because of an invalid value of the Password_data field, it is required that a call to the GetRandomNumber command is issued before attempting a new call to either of these three commands, otherwise their execution will fail regardless of the new value of the Password_data field.

Note: If the latest execution of a PresentPassword / ToggleUntraceable command was successful, it is not necessary to issue a new call to the GetRandomNumber command before issuing a new PresentPassword / Kill / ToggleUntraceable request.

Assuming these constraints are fulfilled, let the RND_NUMBER_4B and RND_NUMBER_8B values be computed from the concatenation of the RND_NUMBER register value returned by the latest call to the GetRandomNumber request.

Table 28. RND_NUMBER_4B

b31-b16	b15-b0
RND_NUMBER	RND_NUMBER

Table 29. RND_NUMBER_8B

b63-b48	b47-b32	b31-b16	b15-b0
RND_NUMBER	RND_NUMBER	RND_NUMBER	RND_NUMBER

Let PASSWORD_4B (resp. PASSWORD_8B) be the unencrypted value of a 32-bit (resp. 64-bit) password to be transmitted over a PresentPassword / WritePassword / Kill / ToggleUntraceable request.

The Password_data field in a request frame shall be computed as follows :

- for a 32-bit password :
 - $\text{Password_data} = \text{XOR}(\text{RND_NUMBER_4B}, \text{PASSWORD_4B})$
- for a 64-bit password :
 - $\text{Password_data} = \text{XOR}(\text{RND_NUMBER_8B}, \text{PASSWORD_8B})$

Table 30. Example of 64-bit Password_data value computation

Data name	b63-b56	b55-b48	b47-b40	b39-b32	b31-b24	b23-b16	b15-b8	b7-b0
RND_NUMBER	-	-	-	-	-	-	1Dh	E6h
RND_NUMBER_8B	1Dh	E6h	1Dh	E6h	1Dh	E6h	1Dh	E6h
PASSWORD_8B	FAh	D7h	5Eh	15h	CAh	A5h	D0h	D4h
Password_data	E7h	31h	43h	F3h	D7h	43h	CDh	32h

Note: A field coded on several bytes – such as Password_data – is transmitted in LSB to MSB byte order in ISO15693 request and response frames

When processing a PresentPassword / Kill / ToggleUntraceable request, the ST25TVxxxC device decrypts the Password_data field to obtain the unencrypted value PASSWORD_4B (or PASSWORD_8B), which is used for comparison with the password register identified by the Password_id field.

When processing a WritePassword request, the ST25TVxxxC device decrypts the Password_data field to obtain the unencrypted value PASSWORD_4B (or PASSWORD_8B) , which is used for update of the password register identified by the Password_id field.

5.1.4 User memory protection

A read and/or write access protection can be globally applied to the blocks of an area. Such protection can be individually configured for AREA1 and AREA2, thanks to the RW_PROTECTION_A1 and RW_PROTECTION_A2 registers (see [Table 11. RW_PROTECTION_A1 content](#) and [Table 15. RW_PROTECTION_A2 content](#)).

On factory delivery, access to AREA1 and AREA2 are not protected. When updating RW_PROTECTION_Ax registers, the new protection mode is effective during the boot sequence of the next RF session.

In addition to the area protection mechanism, the write access to each block composing AREA1 and AREA2 can be individually locked thanks to the LockBlock command.

Block 00h is an exception to the area protection mechanism:

- when block 00h is not locked, the protection of its write access is determined by the value of RW_PROTECTION_A1 register, like other blocks of AREA1
- read access to block 00h is always allowed, regardless of the value of RW_PROTECTION_A1 register

The RW_PROTECTION_A1 register is locked when register LCK_A1 is set to 1b.

The RW_PROTECTION_A2 register is locked when register LCK_A2 is set to 1b.

The END_A1 register is locked when either of LCK_A1 and LCK_A2 registers is set to 1b.

Retrieve the security status of a user memory block

User can read a block security status (BSS) by issuing following commands:

- GetMultipleBlockSecurityStatus
- ReadSingleBlock with Option_flag set to 1
- ReadMultipleBlocks with Option_flag set to 1

For each block, ST25TVxxxC will respond with a BSS byte containing a Lock_bit flag (b0 in [Table 31](#)) as specified in ISO 15693 standard.

Table 31. Block security status

b7	b6	b5	b4	b3	b2	b1	b0
0: RFU							0: Write access to current block granted 1: Write access to current block denied

This Lock_bit flag is set to one if write access to the corresponding block is not allowed. This happens when either of the following conditions is met:

- the write access to the block was permanently locked (corresponding bit of LCK_BLOCK register set to 1b) by a successful LockBlock command
- write access to parent area is protected (RW_PROTECTION_Ax = 01b or 10b at start of the RF session) and security session is closed
- write access to parent area is forbidden (RW_PROTECTION_Ax = 11b at start of the RF session)

5.1.5 System configuration memory protection

Configurations registers listed [Table 4. List of configuration registers](#) are accessed using the ReadConfiguration and WriteConfiguration commands.

Configuration registers are grouped by feature. A group is identified by parameter FID, a register from this group is identified by parameter PID.

Write access to configuration registers is protected or forbidden.

Note: Write access to read-only configuration registers is forbidden

Protected write access to a configuration register is granted when the CONFIG security session is open, and its parent group is not permanently locked.

Read access to configuration registers is protected or always allowed. Protected read access to a configuration register is granted when the CONFIG security session is open, and its parent group is not permanently locked.

On factory delivery, configuration groups are not locked (all bits of LCK_CONFIG register are set to 0b). A configuration group identified by FID (00h, 01h, 02h, 03h, 04h, 05h or 08h) can be permanently locked by setting bit FID of LCK_CONFIG register to 1b:

- if the read access to a configuration register from this group was protected, the register can no longer be read even if CONFIG security session is open
- if the write access to a configuration register from this group was protected, the register can no longer be written even if CONFIG security session is open
- write access to LCK_CONFIG register (FID=FFh, PID=00h) is granted when the CONFIG security session is open
- user cannot unlock a configuration group by setting bit FID of LCK_CONFIG back to 0b, even after opening CONFIG security session (Lock is permanent)
- user may lock several configuration groups with a single WriteConfiguration command by setting the respective bits of LCK_CONFIG to 1b in the request

System registers listed in [Table 5. List of system registers](#) include passwords, device identification registers, lock status and command status.

Read access to system registers is available except for passwords, AFI and DSFID lock status, Kill and ToggleUntraceable command status.

Device identification registers are detailed in section 5.10:

- Write access to AFI and DSFID registers can be respectively locked by LockAFI and LockDSFID commands. Lock is permanent: once locked, write access to AFI and DSFID registers is forbidden.
- Other device identification registers (IC_REF, UID) are read only registers.

5.2 Unique tap code

5.2.1 Unique tap code registers

Table 32. UTC_EN access

RF command	Access type
ReadConfiguration @(FID=02h, PID=00h)	R : always possible
WriteConfiguration @(FID=02h, PID=00h)	W : if the CONFIG security session is open and LCK_UTC=0b
	W effective time : on next RF boot sequence

Table 33. UTC_EN content

Bit	Name	Function	Factory value
b0	UTC_EN	0: Unique tap code is disabled 1: Unique tap code is enabled	0b
b7-b1	RFU	-	0000000b

Note: Refer to [Table 4. List of configuration registers for the UTC_EN register](#).

Table 34. UTC access

RF command	Access type
ReadConfiguration @(FID=02h, PID=01h)	R : always possible
-	W : no write access ⁽¹⁾

1. the content of the UTC register is updated internally during the RF boot sequence when UTC_EN is set to 1b

Table 35. UTC content

Bit	Name	Function	Factory value
b23-b0	UTC	Unique tap code value	Not applicable

Note: Refer to Table 4. List of configuration registers for the UTC register.

5.2.2 Unique tap code description

When the UTC_EN register is set to 1b, the content of the UTC register is updated internally with a fresh value during each RF boot sequence. The content of the UTC register is coded in ASCII format.

The UTC_EN register is locked when register LCK_UTC is set to 1b.

Note: When the Unique tap code is enabled, the duration of the RF boot sequence t_{Boot_RF} (see section 8.2) is:

- compliant with the 5ms guard-time value defined in the NFC Forum [DIGITAL] specification
- not compliant with the 1ms guard-time value defined in the ISO15693 specification

Refer to "AN5578 - Unique tap code for ST25TV512C and ST25TV02KC devices", for more details on the content of the UTC register. Contact your STMicroelectronics sales office to get this document.

5.3 Tamper detection

The tamper detection feature is available on ST25TV02KC-T devices only (see section 10). On ST25TVxxxC-A devices, ReadConfiguration and WriteConfiguration commands requested with FID=03h fail with error code 10h.

5.3.1 Tamper detection registers

Table 36. TD_EVENT_UPDATE_EN access

RF command	Access type
ReadConfiguration @(FID=03h, PID=00h)	R : always possible
WriteConfiguration @(FID=03h, PID=00h)	W : if the CONFIG security session is open and LCK_TD=0b
	W effective time : on next RF boot sequence

Table 37. TD_EVENT_UPDATE_EN content

Bit	Name	Function	Factory value
b0	TD_EVENT_UPDATE_EN	0: memorization of tamper events disabled 1: memorization of tamper events enabled	0b
b7- b1	RFU	-	0000000b

Note: Refer to Table 4. List of configuration registers for the TD_EVENT_UPDATE_EN register.

Table 38. TD_SEAL_MSG access

RF command	Access type
ReadConfiguration @(FID=03h, PID=01h)	R : if the CONFIG security session is open and LCK_TD=0b
WriteConfiguration @(FID=03h, PID=01h)	W : if the CONFIG security session is open and LCK_TD=0b
	W effective time : immediate

Table 39. TD_SEAL_MSG content

Bit	Name	Function	Factory value
b15-b0	TD_SEAL_MSG	Value of TD_EVENT displayed before first occurrence of a TD_UNSEAL event	3030h

Note: Refer to [Table 4. List of configuration registers](#) for the TD_SEAL_MSG register.

Table 40. TD_UNSEAL_MSG access

RF command	Access type
ReadConfiguration @(FID=03h, PID=02h)	R : if the CONFIG security session is open and LCK_TD=0b
WriteConfiguration @(FID=03h, PID=02h)	W : if the CONFIG security session is open and LCK_TD=0b
	W effective time : immediate

Table 41. TD_UNSEAL_MSG content

Bit	Name	Function	Factory value
b15-b0	TD_UNSEAL_MSG	Value of TD_EVENT displayed after first occurrence of a TD_UNSEAL event	5555h

Note: Refer to [Table 4. List of configuration registers](#) for the TD_UNSEAL_MSG register.

Table 42. TD_RESEAL_MSG access

RF command	Access type
ReadConfiguration @(FID=03h, PID=03h)	R : if the CONFIG security session is open and LCK_TD=0b
WriteConfiguration @(FID=03h, PID=03h)	W : if the CONFIG security session is open and LCK_TD=0b
	W effective time : immediate

Table 43. TD_RESEAL_MSG content

Bit	Name	Function	Factory value
b15-b0	TD_RESEAL_MSG	Value of TD_EVENT displayed after occurrence of a TD_RESEAL event	5252h

Note: Refer to [Table 4. List of configuration registers](#) for the TD_RESEAL_MSG register.

Table 44. TD_SHORT_MSG access

RF command	Access type
ReadConfiguration @(FID=03h, PID=04h)	R : if the CONFIG security session is open and LCK_TD=0b
WriteConfiguration @(FID=03h, PID=04h)	W : if the CONFIG security session is open and LCK_TD=0b
	W effective time : immediate

Table 45. TD_SHORT_MSG content

Bit	Name	Function	Factory value
b7- b0	TD_SHORT_MSG	Message displayed when the tamper loop was in closed status during the latest boot sequence	63h

Note: Refer to [Table 4. List of configuration registers for the TD_SHORT_MSG register.](#)

Table 46. TD_OPEN_MSG access

RF command	Access type
ReadConfiguration @(FID=03h, PID=05h)	R : if the CONFIG security session is open and LCK_TD=0b
WriteConfiguration @(FID=03h, PID=05h)	W : if the CONFIG security session is open and LCK_TD=0b
	W effective time : immediate

Table 47. TD_OPEN_MSG content

Bit	Name	Function	Factory value
b7- b0	TD_OPEN_MSG	Message displayed when the tamper loop was in open status during the latest boot sequence	6Fh

Note: Refer to [Table 4. List of configuration registers for the TD_OPEN_MSG register.](#)

Table 48. TD_STATUS access

RF command	Access type
ReadConfiguration @(FID=03h, PID=06h)	R : always possible
-	W : no write access

Table 49. TD_STATUS content

Bit	Name	Function	Factory value
b15-b0	TD_EVENT	TD_SEAL_MSG, TD_UNSEAL_MSG or TD_RESEAL_MSG according to result of tamper event detection	Not applicable
b23-b16	TD_LOOP	TD_SHORT_MSG or TD_OPEN_MSG according to the status of the tamper loop during the latest boot sequence	Not applicable

Note: Refer to [Table 5. List of system registers for the TD_STATUS register.](#)

5.3.2 Tamper detection description

The tamper detection feature allows to check the shortage status between the TD0 and TD1 pins of the ST25TV02KC-T, and monitor tamper events.

See [Section 8.2 RF electrical parameters](#) for recommended impedance values R_{open} and R_{closed} in cases of open and closed tamper loop.

The shortage status TD_LOOP and event status TD_EVENT are read in the response to a ReadConfiguration request with FID=03h and PID=06h.

This is the customer responsibility to check the values of TD_LOOP and TD_EVENT and behave accordingly.

TD_LOOP

The shortage status TD_LOOP is captured by ST25TV02KC-T each time that the device is powered-up. Value of TD_LOOP is equal to value of:

- TD_SHORT_MSG when TD0 and TD1 were connected at capture time
- TD_OPEN_MSG when TD0 and TD1 were not connected at capture time

This information will be lost during power off (no permanent storage of TD_LOOP).

TD_EVENT

The TD_EVENT status is used to monitor the first occurrences of TD_UNSEAL and TD_RESEAL events defined as follows:

- TD_UNSEAL: TD_EVENT_UPDATE_EN register was set to 1b, and TD0 and TD1 were not connected at capture time
- TD_RESEAL: TD_EVENT_UPDATE_EN register was set to 1b, TD_UNSEAL already occurred, and TD0 and TD1 were connected at capture time

On factory delivery, TD_EVENT_UPDATE_EN register is set to 0b and value of TD_EVENT is set to the value of TD_SEAL_MSG.

When the TD_UNSEAL event occurs, TD_EVENT is set to the value of TD_UNSEAL_MSG during the RF boot sequence.

When the TD_RESEAL event occurs, TD_EVENT is set to the value of TD_RESEAL_MSG during the RF boot sequence.

This information will be kept during power off (permanent storage of TD_EVENT).

When the LCK_TD register is set to 1b, the TD_EVENT_UPDATE_EN, TD_SEAL_MSG, TD_UNSEAL_MSG, TD_RESEAL_MSG, TD_SHORT_MSG and TD_OPEN_MSG registers are locked.

Note: When TD_UNSEAL or TD_RESEAL event occurs, the duration of the RF boot sequence t_{Boot_RF} (see Section 8.2 RF electrical parameters) is:

- compliant with the 5ms guard-time value defined in the NFC Forum [DIGITAL] specification
- not compliant with the 1ms guard-time value defined in the ISO15693 specification

Note: When TD_EVENT_UPDATE_EN and UTC_EN registers are set to 0b, no programming of the EEPROM occurs during the RF boot sequence, and its duration is compliant with the 1ms guard-time value defined in the ISO15693 specification.

Note: Tamper detection events occurring outside of the capture window (for instance while the IC is in POWER-OFF state, or during the RF session following the boot sequence) are **not** detected by the ST25TV02KC-T.

5.4 Augmented NDEF

5.4.1 Augmented NDEF registers

Table 50. ANDEF_EN access

RF command	Access type
ReadConfiguration @(FID=04h, PID=00h)	R : always possible
WriteConfiguration @(FID=04h, PID=00h)	W : if the CONFIG security session is open and LCK_ANDEF=0b W effective time : on next RF boot sequence

Table 51. ANDEF_EN content

Bit	Name	Function	Factory value
b0	ANDEF_EN	0: ANDEF feature is disabled,	0b

Bit	Name	Function	Factory value
		1: ANDEF feature is enabled	
b7- b1	RFU	-	0000000b

Note: Refer to [Table 4. List of configuration registers for the ANDEF_EN register.](#)

Table 52. ANDEF_CFG access

RF command	Access type
ReadConfiguration @(FID=04h, PID=01h)	R : always possible
WriteConfiguration @(FID=04h, PID=01h)	W : if the CONFIG security session is open and LCK_ANDEF=0b W effective time : on next RF boot sequence

Table 53. ANDEF_CFG content

Bit	Name	Function	Factory value
b0	ANDEF_UID_EN	0: UID field disabled in ANDEF feature 1: UID field enabled in ANDEF feature	0b
b1	ANDEF_CUS_EN	0: Custom field disabled in ANDEF feature 1: Custom field enabled in ANDEF feature	0b
b2	ANDEF_UTC_EN	0: Unique tap code field disabled in ANDEF feature 1: Unique tap code field enabled in ANDEF feature	0b
b3	RFU	-	0b
b4	ANDEF_TD_EN ⁽¹⁾	0: Tamper detection field disabled in ANDEF feature 1: Tamper detection field enabled in ANDEF feature	0b
b5	ANDEF_SEP_EN	0: ANDEF field separator disabled 1: ANDEF field separator enabled	1b
b7- b6	ANDEF_BYTE	Byte offset in block ANDEF_BLOCK where the ANDEF feature starts operating	00b
b15-b8	ANDEF_BLOCK	Block address where the ANDEF feature starts operating	00h

1. relevant on ST25TV02KC-T devices only, forced to 0b on ST25TVxxxC-A devices

Note: Refer to [Table 4. List of configuration registers for the ANDEF_CFG register.](#)

Table 54. ANDEF_SEP access

RF command	Access type
ReadConfiguration @(FID=04h, PID=02h)	R : if the CONFIG security session is open and LCK_ANDEF=0b
WriteConfiguration @(FID=04h, PID=02h)	W : if the CONFIG security session is open and LCK_ANDEF=0b W effective time : immediate

Table 55. ANDEF_SEP content

Bit	Name	Function	Factory value
b7- b0	ANDEF_SEP	Character used as ANDEF field separator when ANDEF_SEP_EN=1b	78h

Note: Refer to [Table 4. List of configuration registers for the ANDEF_SEP register.](#)

Table 56. ANDEF_CUSTOM_LSB access

RF command	Access type
ReadConfiguration @(FID=04h, PID=03h)	R : if the CONFIG security session is open and LCK_ANDEF=0b
WriteConfiguration @(FID=04h, PID=03h)	W : if the CONFIG security session is open and LCK_ANDEF=0b W effective time : immediate

Table 57. ANDEF_CUSTOM_LSB content

Bit	Name	Function	Factory value
b31-b0	ANDEF_CUSTOM_LSB	First 4 characters of the ANDEF custom field	2E2E2E2Eh

Note: Refer to [Table 4. List of configuration registers for the ANDEF_CUSTOM_LSB register.](#)

Table 58. ANDEF_CUSTOM_MSB access

RF command	Access type
ReadConfiguration @(FID=04h, PID=04h)	R : if the CONFIG security session is open and LCK_ANDEF=0b
WriteConfiguration @(FID=04h, PID=04h)	W : if the CONFIG security session is open and LCK_ANDEF=0b W effective time : immediate

Table 59. ANDEF_CUSTOM_MSB content

Bit	Name	Function	Factory value
b31-b0	ANDEF_CUSTOM_MSB	Last 4 characters of the ANDEF custom field	2E2E2E2Eh

Note: Refer to [Table 4. List of configuration registers for the ANDEF_CUSTOM_MSB register.](#)

Table 60. ANDEF_UID access

RF command	Access type
ReadSingleBlock ReadMultipleBlocks	R : if ANDEF_EN=1b and ANDEF_UID_EN=1b
-	W : no write access

Table 61. ANDEF_UID content

Bit	Name	Function	Factory value
b127-b0	ANDEF_UID	Value displayed in the UID field of the ANDEF feature	UID in ASCII format starting with "E0"

Note: Refer to [Table 5. List of system registers for the ANDEF_UID register.](#)

5.4.2 Augmented NDEF description

The Augmented NDEF feature (ANDEF) is a contextual automatic NDEF message service, allowing the tag to respond dynamic content without an explicit update of the EEPROM by the end user.

The feature is enabled (resp. disabled) when the value of register ANDEF_EN is 1b (resp. 0b) during the latest RF boot sequence. When the feature is enabled, user memory data at byte addresses ranging from ANDEF_START to ANDEF_END is replaced by the content of a virtual memory ANDEF_MEM in the response to ReadSingleBlock and ReadMultipleBlocks requests.

Note: The BSS values responded to `ReadSingleBlock` and `ReadMultipleBlocks` requests are not modified when the ANDEF feature is enabled

Note: The ANDEF feature has no effect on the `WriteSingleBlock` command. When the feature is enabled, and a `WriteSingleBlock` command is issued on a block crossing the `[ANDEF_START:ANDEF_END]` range, the data from the command is directly written to user memory, without replacement by volatile memory content.

Table 62. Block data read when ANDEF feature is disabled on ST25TV02KC

Block address	Block data ⁽¹⁾				Comment
	Byte0	Byte1	Byte2	Byte3	
00h	UM000	UM001	UM002	UM003	First block of UM ⁽²⁾
...	No bytes read from ANDEF_MEM memory
4Fh ⁽³⁾	UM316	UM317	UM318	UM319	Last block of UM ⁽²⁾

1. Block data responded to `ReadSingleBlock` and `ReadMultipleBlocks` requests.
2. UM stands for user memory.
3. ST25TV02KC memory size is used in this example. Note that last block address is 0Fh on ST25TV512C devices.

Table 63. Block data read when ANDEF feature is enabled on ST25TV02KC

Block address	Block data ⁽¹⁾				Comment
	Byte0	Byte1	Byte2	Byte3	
00h	UM000	UM001	UM002	UM003	First block of UM ⁽²⁾
...	-
2Dh	UM180	UM181	UM182	UM183	Example with ANDEF_START=185 and ANDEF_END=190 (6 bytes of UM ⁽²⁾ replaced with AM ⁽³⁾)
2Eh	UM184	AM000	AM001	AM002	
2Fh	AM003	AM004	AM005	UM191	
30h	UM192	UM193	UM194	UM195	
...	-
4Fh ⁽⁴⁾	UM316	UM317	UM318	UM319	Last block of UM ⁽²⁾

1. Block data responded to `ReadSingleBlock` and `ReadMultipleBlocks` requests.
2. UM stands for user memory
3. AM stands for ANDEF_MEM memory
4. ST25TV02KC memory size is used in this example. Note that last block address is 0Fh on ST25TV512C devices.

Byte addresses ANDEF_START and ANDEF_END depend on the value of register ANDEF_CFG during the latest RF boot sequence:

- $ANDEF_START = ANDEF_BLOCK * 4 + ANDEF_BYTE$
- $ANDEF_END = \min(END_MEM * 4 + 3, ANDEF_START + ANDEF_LEN - 1)$

Where ANDEF_LEN is the number of bytes available from ANDEF_MEM memory:

- $ANDEF_LEN = ANDEF_UID_EN * 16 + ANDEF_CUS_EN * 8 + ANDEF_UTC_EN * 3 + ANDEF_TD_EN * 3 + ANDEF_SEP_EN * (ANDEF_UID_EN + ANDEF_CUS_EN + ANDEF_UTC_EN + ANDEF_TD_EN - 1)$

Content of ANDEF_MEM depends on the values of ANDEF_CFG, ANDEF_UID, ANDEF_CUSTOM_LSB, ANDEF_CUSTOM_MSB, UTC, TD_STATUS and ANDEF_SEP registers.

The content of ANDEF_MEM is the result of the concatenation of ANDEF fields. Each field corresponds to a configuration register. The order of appearance, content and condition of presence of each field is listed in the table below.

Table 64. ANDEF fields concatenated in ANDEF_MEM

Order	Content ⁽¹⁾	Bytes	Condition of presence
1	ANDEF_UID	16	ANDEF_UID_EN=1b
2	ANDEF_SEP	1	ANDEF_UID_EN=1b and ANDEF_CUS_EN=1b and ANDEF_SEP_EN=1b
3	ANDEF_CUSTOM_LSB	4	ANDEF_CUS_EN=1b
4	ANDEF_CUSTOM_MSB	4	ANDEF_CUS_EN=1b
5	ANDEF_SEP	1	(ANDEF_UID_EN=1b or ANDEF_CUS_EN=1b) and ANDEF_UTC_EN=1b and ANDEF_SEP_EN=1b
6	UTC	3	ANDEF_UTC_EN=1b
7	ANDEF_SEP	1	(ANDEF_UID_EN=1b or ANDEF_CUS_EN=1b or ANDEF_UTC_EN=1b) and ANDEF_TD_EN=1b ⁽²⁾ and ANDEF_SEP_EN=1b
8	TD_STATUS	3	ANDEF_TD_EN=1b ⁽²⁾

1. When a register value is coded on several bytes, it is copied in LSB to MSB byte order in the ANDEF_MEM memory.
2. TD_STATUS field available on ST25TV02KC-T devices only

As an example, Figure 7 shows the usage of the ANDEF feature to display the value of the ANDEF_UID and TD_STATUS registers in a NDEF URI message : the content of the NDEF message may change after a tamper detection event without modification of the user memory content.

Figure 7. Example of augmented NDEF message on ST25TV02KC-T

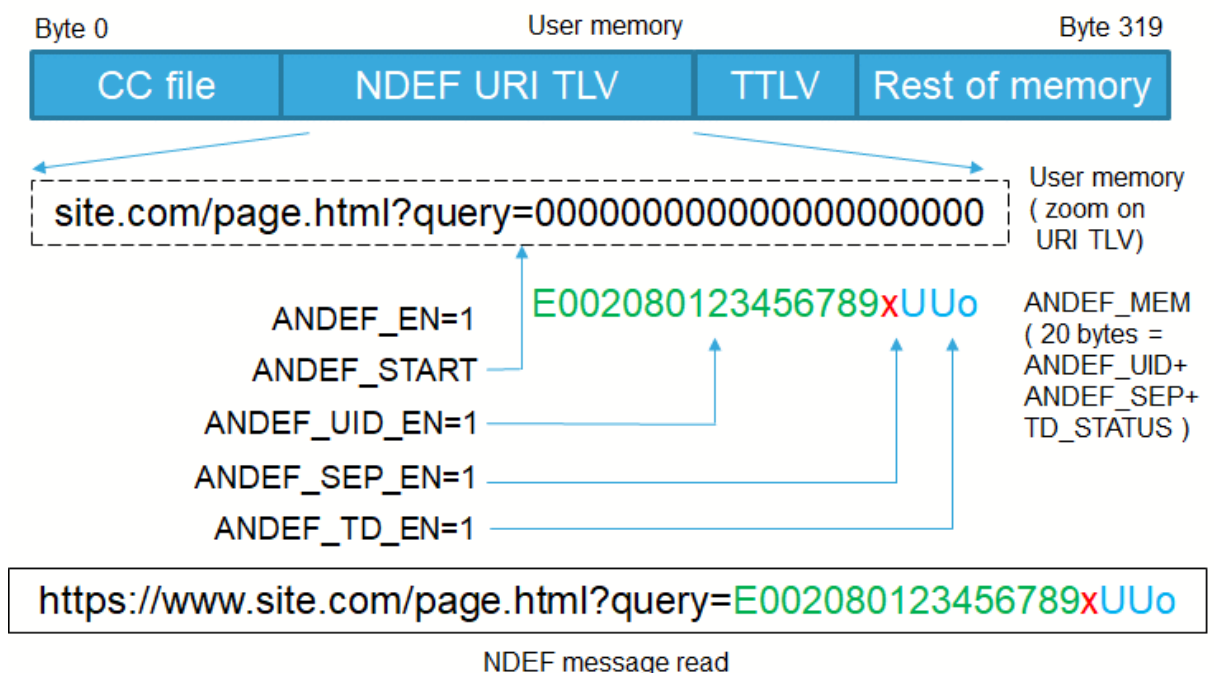

On factory delivery, ANDEF_EN register is set to 0b and ANDEF_CFG register is set to 0020h. When the LCK_ANDEF register is set to 1b, ANDEF_EN, ANDEF_CFG, ANDEF_SEP, ANDEF_CUSTOM_LSB and ANDEF_CUSTOM_MSB registers are locked.

5.5 Consumer privacy protection

The Kill and Untraceable features offer consumer privacy capabilities required by the GDPR.

5.5.1 Example of Augmented NDEF message Privacy registers

Table 65. KILL_CMD access

RF command	Access type
-	R : no read access
Kill	W : if Kill command responds with Error_flag=0b
	W effective time : immediate

Table 66. KILL_CMD content

Bit	Name	Function	Factory value
b0	KILL_CMD	0: successful Kill command did not occur 1: successful Kill command did occur	0b

Note: Refer to [Table 5. List of system registers for the KILL_CMD register.](#)

Table 67. UNTR_CMD access

RF command	Access type
-	R : no read access
ToggleUntraceable	W : if ToggleUntraceable command responds with Error_flag=0b
	W effective time : immediate

Table 68. UNTR_CMD content

Bit	Name	Function	Factory value
b0	UNTR_CMD	0: last successful ToggleUntraceable command occurred with Address_flag=0b 1: last successful ToggleUntraceable command occurred with Address_flag=1b	0b

Note: Refer to [Table 5. List of system registers for the UNTR_CMD register.](#)

Table 69. PRIVACY access

RF command	Access type
ReadConfiguration @(FID=05h, PID=00h)	R : always possible
WriteConfiguration @(FID=05h, PID=00h)	W : if the CONFIG security session is open and LCK_PRIV=0b
	W effective time : on next RF boot sequence

Table 70. PRIVACY content

Bit	Name	Function	Factory value
b1- b0	UNTR_DFT	00: device boots in UNTRACEABLE state when UNTR_CMD=1b 01: device always boots in UNTRACEABLE state 10: device boots in UNTRACEABLE state when UNTR_CMD=1b or tamper loop is closed 11: device boots in UNTRACEABLE state when UNTR_CMD=1b or tamper loop is open	00b

Bit	Name	Function	Factory value
b2	DIS_INV	0: Inventory command responds in UNTRACEABLE state 1: Inventory command is mute in UNTRACEABLE state	0b
b3	DIS_KILL	0: Kill command is enabled 1: Kill command is disabled	0b
b7- b4	RFU	-	0000b

Note: Refer to [Table 4. List of configuration registers for the PRIVACY register.](#)

5.5.2 Kill feature description

When the ST25TVxxxC is in KILLED state, all incoming RF requests are ignored.

The ST25TVxxxC enters the KILLED state on a successful Kill command (see [Section 6.4.20 Kill](#)), which sets the KILL_CMD register to 1b. Once the ST25TVxxxC has entered the KILLED state, it can only switch between the POWER-OFF and KILLED states (see [Section 6.2.8 ISO15693 states](#)).

The Kill command is enabled/disabled when the DIS_KILL register respectively has value 0/1b during the latest boot sequence. The update of the DIS_KILL register is effective on the next RF boot sequence.

While the Kill command is disabled, the Kill request is ignored and the ST25TVxxxC can not enter the KILLED state.

On factory delivery, the KILL_CMD and DIS_KILL registers are set to 0b.

When the LCK_PRIV register is set to 1b, the DIS_KILL register is locked.

5.5.3 Untraceable feature description

When the ST25TVxxxC is in UNTRACEABLE state, all incoming RF requests are ignored except:

- GetRandomNumber and ToggleUntraceable requests (see [Section 6.4.23 ToggleUntraceable](#) and [Section 6.4.24 GetRandomNumber](#))
- Inventory and ReadSingleBlock (block 00h only) requests if value of DIS_INV register was 0b during the latest RF boot sequence

The ST25TVxxxC enters the UNTRACEABLE state on a successful ToggleUntraceable command requested with Address_flag=1b, which sets the UNTR_CMD register to 1b.

The ST25TVxxxC leaves the UNTRACEABLE state on a successful ToggleUntraceable command requested with Address_flag=0b, which sets the UNTR_CMD register to 0b.

After a RF boot sequence, the ST25TVxxxC enters the UNTRACEABLE state if KILL_CMD register is set to 0b and either of the following conditions is met:

- value of UNTR_CMD register is 1b
- value of UNTR_DFT register is 01b
- value of UNTR_DFT register is 10b and tamper loop is closed (ST25TV02KC-T devices only)
- value of UNTR_DFT register is 11b and tamper loop is open (ST25TV02KC-T devices only)

See [Section 6.2.8 ISO15693 states](#) for further details.

Note: After a RF boot sequence with KILL_CMD=UNTR_CMD=0b and UNTR_DFT=10b :

- the ST25TV02KC-T enters the **UNTRACEABLE** state if the tamper loop is **closed**
- the ST25TV02KC-T enters the **READY** state if the tamper loop is **open**

Note: After a RF boot sequence with KILL_CMD=UNTR_CMD=0b and UNTR_DFT=11b:

- the ST25TV02KC-T enters the **UNTRACEABLE** state if the tamper loop is **open**
- the ST25TV02KC-T enters the **READY** state if the tamper loop is **closed**

Note: On ST25TVxxxC-A devices, 10b and 11b values of UNTR_DFT register are interpreted as value 00b.

Untraceability of the customer is claimed for the following reasons :

- in a NFC Forum application, block 00h contains the CC file which does not allow to identify a customer
- user blocks 01h to END_MEM - which contain customer data - can not be accessed in UNTRACEABLE state

- while in UNTRACEABLE state, the UID value used in request and response frames of Inventory and ReadSingleBlock commands is fixed (see Section 7.1 Untraceable UID) and does not allow to identify a customer

Furthermore, the user may configure the ST25TVxxxC to ignore Inventory and ReadSingleBlock requests in UNTRACEABLE state, by setting the DIS_INV register to 1b.

The update of the DIS_INV and UNTR_DFT registers is effective on the next RF boot sequence. On factory delivery, the DIS_INV and UNTR_DFT registers are set to 0.

When the LCK_PRIV register is set to 1b, the UNTR_DFT and DIS_INV registers are locked.

5.6 TruST25™ digital signature

The ST25TVxxxC devices support the TruST25 digital signature feature, which allows the user to verify the authenticity of the device, thanks to a unique digital signature.

TruST25 solution encompasses secure industrialization processes and tools deployed by STMicroelectronics to generate, store and check the signature in the device.

Refer to “AN5580 - TruST25™ digital signature for ST25TV512C and ST25TV02KC devices”, for more details on how to use it. Contact your STMicroelectronics sales office to get this document.

5.7 AFI protection

5.7.1 AFI protection registers

Table 71. AFI_PROT access

RF command	Access type
ReadConfiguration @(FID=08h, PID=00h)	R : always possible
WriteConfiguration @(FID=08h, PID=00h)	W : if the CONFIG security session is open and LCK_AFI=0b W effective time : on next RF boot sequence

Table 72. AFI_PROT content

Bit	Name	Function	Factory value
b0	AFI_PROT	0: WriteAFI and LockAFI commands do not depend from AREA1 security session 1: WriteAFI and LockAFI commands fail when AREA1 security session is closed	0b
b7- b1	RFU	-	0000000b

Note: Refer to Table 4. List of configuration registers for the AFI_PROT register.

5.7.2 AFI protection description

This feature allows to protect the WriteAFI and LockAFI commands with the AREA1 security session, and is configured by register AFI_PROT.

On factory delivery, the AFI_PROT register is set to 0b. When AFI_PROT register is set to 0b:

- the WriteAFI command is successful if the LCK_AFI register is set to 0b, and fails otherwise
- the LockAFI command is successful if the LCK_AFI register is set to 0b, and fails otherwise

When AFI_PROT register is set to 1b:

- the WriteAFI command is successful if AREA1 security session is open and the LCK_AFI register is set to 0b, and fails otherwise
- the LockAFI command is successful if AREA1 security session is open and the LCK_AFI register is set to 0b, and fails otherwise

When the LCK_AFI register is set to 1b, the AFI_PROT register is locked.

5.8 Inventory Initiated

ST25TVxxxC provides a special feature to improve the anticollision sequence on moving tags using the `Initiate_flag` volatile register. This register, controlled by the `Initiate` command (refer to [Section 6.4.21 Initiate](#)), allows ST25TVxxxC to respond to `InventoryInitiated` requests (refer to [Section 6.4.22 InventoryInitiated](#)).

For applications where multiple tags are crossing the RF field of a reader, it is possible to miss tags when the standard `Inventory` command is used. The reason is that the anticollision sequence performs a global tree search, calling the command at each node and leaf of the tree. In a worst case, a tag WC waits a long delay before it is inventoried as a leaf of the search. Such delay can be furthermore increased by tags entering the RF field of the reader during the search, and tag WC may have left the field before being inventoried.

This usecase can be improved by replacing the standard `Inventory` command with the custom `InventoryInitiated` command in the anticollision sequence. When multiple tags are crossing the RF field of the reader, the anticollision sequence is started by an `Initiate` command which initiates the set of tags within range. `InventoryInitiated` requests are ignored by tags entering the RF field after the `Initiate` command, they are only processed by the set of initiated tags, hence bounding the time necessary to complete the anticollision sequence. When an initiated tag is inventoried, it is sent to QUIET state to ignore further `InventoryInitiated` requests.

Once an anticollision sequence is completed, the reader starts a new sequence that will operate only on tags which have entered the RF field during the previous sequence, and so on.

5.9 Device identification registers

Registers described in this section are located in System configuration memory. Refer to section 4.3 for more details.

Table 73. LCK_DSFD access

RF command	Access type
-	R : no read access
LockDSFD	W : if LCK_DSFD=0b W effective time : immediate

Table 74. LCK_DSFD content

Bit	Name	Function	Factory value
b0	LCK_DSFD	0: successful LockDSFD command did not occur 1: successful LockDSFD command did occur	0b

Note: Refer to [Table 5. List of system registers for the LCK_DSFD register](#).

Table 75. LCK_AFI access

RF command	Access type
-	R : no read access
LockAFI	W : if LCK_AFI=0b and (AFI_PROT=0b or AREA1 security session is open) W effective time : immediate

Table 76. LCK_AFI content

Bit	Name	Function	Factory value
b0	LCK_AFI	0: successful LockAFI command did not occur 1: successful LockAFI command did occur	0b

Note: Refer to [Table 5. List of system registers for the LCK_AFI register](#).

Table 77. DSFID access

RF command	Access type
Inventory	R : always possible
GetSystemInfo	R : always possible
ExtendedGetSystemInfo	R : always possible
Initiate	R : always possible
InventoryInitiated	R : always possible
WriteDSFID	W : if LCK_DSFID=0b
	W effective time : immediate

Table 78. DSFID content

Bit	Name	Function	Factory value
b7-b0	DSFID	ISO/IEC 15693 Data Storage Format Identifier	00h

Note: Refer to [Table 5. List of system registers for the DSFID register.](#)

Table 79. AFI access

RF command	Access type
GetSystemInfo	R : always possible
ExtendedGetSystemInfo	R : always possible
WriteAFI	W : if LCK_AFI=0b and (AFI_PROT=0b or AREA1 security session is open)
	W effective time : immediate

Table 80. AFI content

Bit	Name	Function	Factory value
b7-b0	AFI	ISO/IEC 15693 Application Family Identifier	00h

Note: Refer to [Table 5. List of system registers for the AFI register.](#)

Table 81. IC_REF access

RF command	Access type
GetSystemInfo	R : always possible
ExtendedGetSystemInfo	R : always possible
-	W : no access

Table 82. IC_REF content

Bit	Name	Function	Factory value
b7-b0	IC_REF	ISO/IEC 15693 IC reference	08h

Note: Refer to [Table 5. List of system registers for the IC_REF register.](#)

Table 83. REV access

RF command	Access type
ReadConfiguration @(FID=FEh, PID=00h)	R : always possible
-	W : no access

Table 84. REV content

Bit	Name	Function	Factory value
b7-b0	REV	IC revision number	00h

Note: Refer to [Table 4. List of configuration registers for the REV register.](#)

Table 85. UID access

RF command	Access type
Inventory	R : always possible
GetSystemInfo	R : always possible
ExtendedGetSystemInfo	R : always possible
Initiate	R : always possible
InventoryInitiated	R : always possible
ReadConfiguration @(FID=FEh, PID=01h)	R : always possible
-	W : no access

Table 86. UID content

Bit	Name	Function	Factory value
b7-b0	UID	ISO/IEC 15693 UID byte 0	IC manufacturer serial number
b15-b8		ISO/IEC 15693 UID byte 1	
b23-b16		ISO/IEC 15693 UID byte 2	
b31-b24		ISO/IEC 15693 UID byte 3	
b39-b32		ISO/IEC 15693 UID byte 4	
b47-b40		ISO/IEC 15693 UID byte 5	08h
b55-b48		ISO/IEC 15693 UID byte 6	02h
b63-b56		ISO/IEC 15693 UID byte 7	E0h

Note: Refer to [Table 5. List of system registers for the UID register.](#)

6 RF Operation

The device follows ISO/IEC 15693 and NFC Forum Type 5 Tag specification for radio- frequency power and signal interface and for anticollision and transmission protocol.

The device communicates via the 13.56 MHz carrier electromagnetic wave on which incoming data are demodulated from the received signal amplitude modulation (ASK: amplitude shift keying). The received ASK wave is 10% or 100% modulated with a data rate of 1.6 Kbit/s using the 1/256 pulse coding mode or a data rate of 26 Kbit/s using the 1/4 pulse coding mode.

Outgoing data are generated by the ST25TVxxxC load variation using Manchester coding with one or two subcarrier frequencies at 423 kHz and 484 kHz. Data are transferred from the ST25TVxxxC at 6.6 Kbit/s in low data rate mode and 26 Kbit/s in high data rate mode.

6.1 RF communication

6.1.1 Access to a ISO/IEC 15693 device

The dialog between the reader and the ST25TVxxxC takes place as follows:

- activation of the ST25TVxxxC by the operating field of the reader
- transmission of a command by the reader (ST25TVxxxC detects carrier amplitude modulation)
- transmission of a response by the ST25TVxxxC using load modulation.

These operations use the power transfer and communication signal interface described below. This technique is called RTF (reader talk first).

Operating field

The ST25TVxxxC operates continuously between the minimum and maximum values of the electromagnetic field H defined in [Table 172. RF characteristics](#). The reader has to generate a field within these limits.

Power transfer

Power is transferred to the ST25TVxxxC by radio frequency at 13.56 MHz via coupling antennas in the ST25TVxxxC and the reader. The operating field of the reader is transformed on the ST25TVxxxC antenna to an AC voltage that is rectified, filtered and internally regulated. During communications, the amplitude modulation (ASK) on this received signal is demodulated by the ASK demodulator.

Frequency

The ISO 15693 standard defines the carrier frequency (f_C) of the operating field as 13.56 MHz \pm 7 kHz.

Note: In this document, f_C symbol is used for the nominal value of f_{CC} ($f_C=13.56$ MHz).

6.2 RF protocol

6.2.1 Protocol description

The transmission protocol (or simply “the protocol”) defines the mechanism used to exchange instructions and data between the VCD (vicinity coupling device) and the VICC (vicinity integrated circuit card) in both directions. It is based on the concept of “VCD talks first”. The device acts as the VICC.

This means that a ST25TVxxxC does not start transmitting unless it has received and properly decoded an instruction sent by the VCD. The protocol is based on an exchange of commands, which consist in request/ response transactions between the VCD and the ST25TVxxxC:

- a request is sent from the VCD to the ST25TVxxxC
- a response to this request is sent from the ST25TVxxxC to the VCD.

Each request and each response are contained in a frame. The frames are delimited by a Start of Frame (SOF) and End of Frame (EOF).

The protocol is bit-oriented. The number of bits transmitted in a frame is a multiple of eight (8), that is an integer number of bytes.

A single-byte field is transmitted least significant bit (LSBit) first. A multiple-byte field is transmitted least significant byte (LSByte) first and each byte is transmitted least significant bit (LSBit) first.

Figure 8. ISO15693 protocol timing

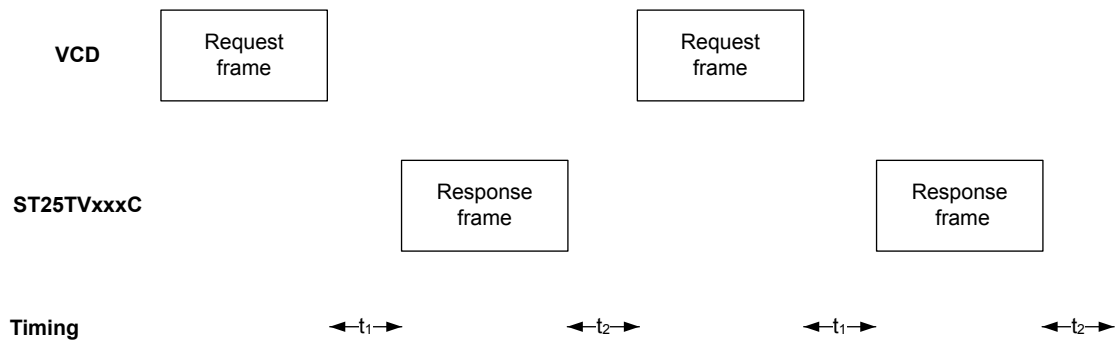

6.2.2 Request format

A request frame consists in :

- a SOF
- request flags
- a command code
- request parameters and data
- a CRC
- an EOF.

Table 87. General request format

SOF	Request_flags	Opcode	Parameters	Data	CRC_B	EOF
-	8 bits	8 bits	optional	optional	16 bits	-

6.2.3 Request flags

In a request frame, the Request_flags field specifies the actions to be performed by the ST25TVxxxC and whether corresponding fields are present or not.

The Request_flags field consists of eight bits indexed from 0 to 7.

Note: Indexing of bits starts from 0 to comply with the convention used in this specification, however note that indexing of these bits starts at 1 in the ISO/IEC 15693 specification.

Bit 2 (Inventory_flag) of Request_flags defines the contents of the four MSBs (bits 4 to 7).

When Inventory_flag value is 0, bits 4 to 7 define the ST25TVxxxC selection criteria.

When Inventory_flag value is 1, bits 4 to 7 define the ST25TVxxxC Inventory parameters.

Table 88. Definition of Request_flags LSBs

Bit	Flag	Description
0	Subcarrier_flag ⁽¹⁾	0 : A single subcarrier is used by the VICC 1 : Two subcarriers are used by the VICC
1	Datarate_flag ⁽¹⁾	0 : Low data rate is used by the VICC 1 : High data rate used by the VICC
2	Inventory_flag	0 : Bits 4 to 7 are described by Table 89 1 : Bits 4 to 7 are described by Table 90
3	Protocol_extension_flag	0 : No protocol format extension 1 : Not supported (RFU)

1. Subcarrier_flag and Datarate_flag refer to the VICC-to-VCD communication.

Table 89. Definition of Request_flags MSBs when Inventory_flag value is 0

Bit	Flag	Description
4	Select_flag ⁽¹⁾	0 : The command is processed according to the value of Address_flag 1 : UID field not present. The command is processed only by the VICC in SELECTED state ⁽²⁾
5	Address_flag ⁽¹⁾	0 : UID field not present. command is processed by any VICC 1 : UID field present. command is processed only by the VICC whose UID matches the field value
6	Option_flag	0 : Option not activated 1 : Option activated
7	RFU_flag	0 : Unless otherwise specified 1 : Not supported (RFU)

1. Select_flag=1 and Address_flag=1 is an invalid case, a request with such setting is ignored by the ST25TVxxxC device.

2. The SELECTED state is defined in section 6.2.8

Table 90. Definition of Request_flags MSBs when Inventory_flag value is 1

Bit	Flag	Description
4	AFI_flag	0 : AFI field is not present 1 : AFI field is present
5	Nb_slots_flag	0 : 16 slots mode 1 : 1 slot mode
6	Option_flag	0 : Option not activated 1 : Option activated
7	RFU_flag	0 : Unless otherwise specified 1 : Not supported (RFU)

6.2.4 Response format

A response frame consists in:

- a SOF
- response flags
- response data
- a CRC
- an EOF

Table 91. General response format

SOF	Response_flags	Response_data	CRC_B	EOF
-	8 bits	optional	16 bits	-

6.2.5 Response flags

In a response frame, the Response_flags field indicates how actions have been performed by the ST25TVxxxC and whether corresponding fields are present or not.

The Response_flags field consists of eight bits indexed from 0 to 7.

Note: Indexing of bits starts from 0 to comply with the convention used in this specification, however note that indexing of these bits starts at 1 in the ISO/IEC 15693 specification.

Table 92. Definition of Response_flags

Bit	Flag	Description
0	Error_flag	0 : No error 1 : Error detected. Error code present in the Data field
1	RFU	0 : Unless otherwise specified 1 : Not supported (RFU)
2		
3		
4		
5		
6		
7		

6.2.6 Response and error codes

If the Error_flag field is set to 1 by the ST25TVxxxC in the response, an Error code field is present and provides information about the error that occurred.

If an error occurs while processing a command, the ST25TxxxC remains silent instead of responding a frame with Error_flag set to 1 when :

- Inventory_flag is set to 1
- Inventory_flag, Select_flag and Address_flag are set to 0

Error codes not specified in [Table 93](#) are reserved for future use.

Table 93. General response format when Error_flag equals 1

SOF	Response_flags	Error_code	CRC_B	EOF
-	01h	8 bits	16 bits	-

Table 94. Definition of response error codes

Error code	Description
01h	Invalid IC Mfg code value
02h	Invalid request format
03h	Invalid Request_flags value
0Fh	Error with no information given
10h	Requested data not available

Error code	Description
11h	Requested data is already locked and thus cannot be locked again
12h	Requested data is locked and its content cannot be changed
13h	Programming of requested data failed
14h	Lock of requested data failed
15h	Requested data is protected in read

6.2.7 Modes

The term “mode” refers to the mechanism used in a command to specify the set of VICC devices that must process a request with Inventory_flag set to 0. Three modes are defined depending on the values of Address_flag and Select_flag defined in [Section 6.2.3 Request flags](#).

Addressed mode

When Address_flag is set to 1 (Addressed mode), the request contains the UID (unique ID) of the addressed VICC.

Any ST25TVxxxC receiving a request with the Address_flag set to 1 compares the received UID to its own. If they match the device processes the request (if possible) and returns a response to the VCD as specified in the command description. Otherwise the device remains silent.

Select mode

When Select_flag is set to 1 (Select mode), the request frame does not contain a UID field. Only the VICC in SELECTED state that receives a request with Select_flag set to 1 processes it and returns a response to the VCD as specified in the command description.

The SELECTED state is defined in section 6.2.8. The system design ensures that only one ST25TVxxxC can be in the SELECTED state at a given time.

Non-Addressed mode (broadcast request)

When Address_flag and Select_flag are set to 0 (Non-Addressed mode), the request frame does not contain a UID field.

Several VICC may answer to a request in Non-Addressed mode, unlike the Addressed and Select modes where at most one VICC is expected to answer.

6.2.8 ISO15693 states

- POWER-OFF
- READY
- QUIET
- SELECTED

Transitions between these states are specified in [Figure 9. ISO15693 state transition diagram](#).

POWER-OFF state

The ST25TVxxxC is in RF POWER-OFF state when it does not receive enough energy from the VCD.

READY state

The ST25TVxxxC boots in READY state when it receives enough energy from the VCD.

When in the READY state, the ST25TVxxxC processes requests in Addressed, or Non-Addressed mode, or with Inventory_flag set to 1. Requests in Select mode are ignored.

QUIET state

When in the QUIET state, the ST25TVxxxC processes any request in Addressed mode. Requests in Select or Non-Addressed mode are ignored (except the ResetToReady command in Non-Addressed mode). Requests with Inventory_flag set to 1 are ignored.

SELECTED state

In the SELECTED state, the ST25TVxxxC processes requests in any addressing mode:

- Request in Select mode
- Request in Addressed mode
- Request in Non-Addressed mode
- Request with Inventory_flag set to 1

Table 95. Request_flags values depending on addressing mode

Request_flags	Non-Addressed	Select	Addressed ⁽¹⁾	Inventory ⁽¹⁾
Inventory_flag	0	0	0	1
Select_flag	0	1	0	-
Address_flag	0	0	1	-

1. assuming UID and Inventory parameter values matching the ST25TVxxxC register values

Table 96. Device response depending on state and addressing mode

ISO15693 state	Non-Addressed	Select	Addressed ⁽¹⁾	Inventory ⁽¹⁾
READY	X	-	X	X
SELECTED	X	X	X	X
QUIET	-(2)	-	X	-

1. assuming UID and Inventory parameter values matching the ST25TVxxxC register values

2. All Non-Addressed requests are ignored in QUIET state, except the Non-Addressed ResetToReady request

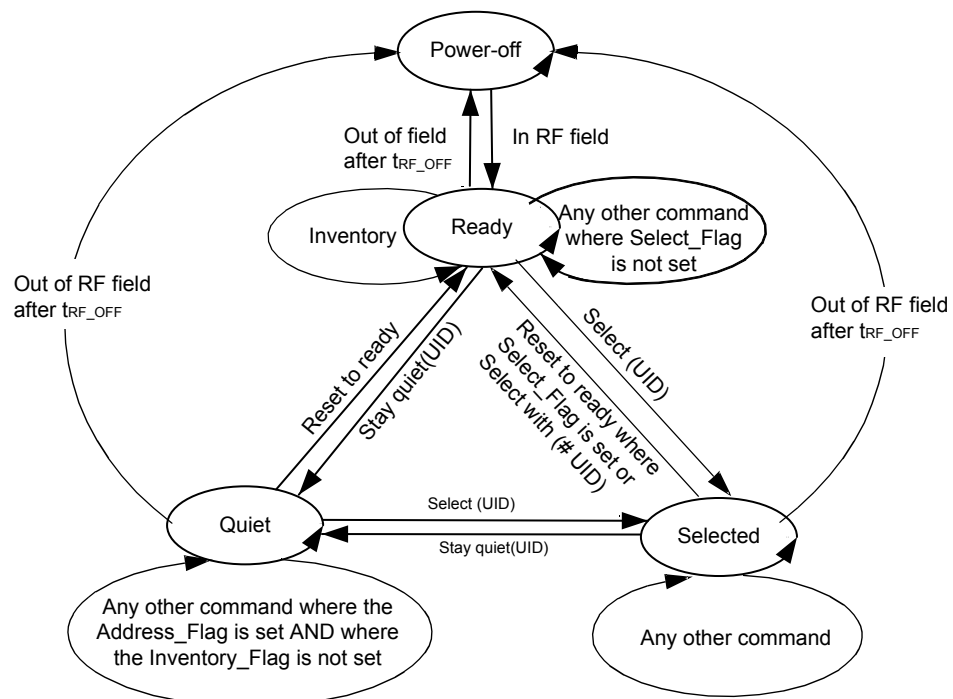
Figure 9. ISO15693 state transition diagram

The ST25TVxxxC returns to the POWER-OFF state if the tag is out of the field for at least t_{RF_OFF} . The intention of the state transition method is that only one ST25TVxxxC must be in the SELECTED state at any given time.

6.2.9 Custom states

In addition to the ISO15693 states described in the previous section, the ST25TVxxxC supports two custom states :

- UNTRACEABLE
- KILLED

Transitions with these states are specified in Figure 10.

UNTRACEABLE state

When in UNTRACEABLE state, the ST25TVxxxC ignores all incoming requests except :

- the GetRandomNumber request in Non-Addressed mode
- the ToggleUntraceable request in Non-Addressed mode
- the Inventory request if value of DIS_INV register at boot-time was 0b
- the ReadSingleBlock request in Addressed mode if value of DIS_INV register at boot-time was 0b and Block_number parameter is set to 00h

KILLED state

When in KILLED state, the ST25TVxxxC ignores all incoming requests.

Figure 10. ST25TVxxxC state transition diagram

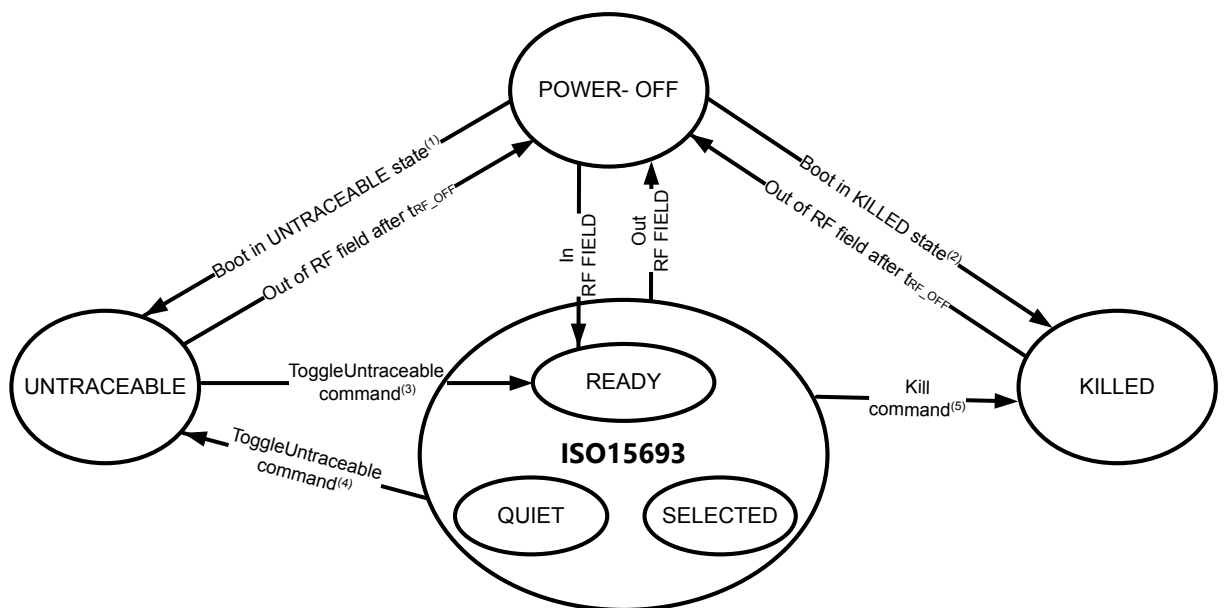

1. ST25TVxxxC boots in UNTRACEABLE state when:
 - in RF field
 - the value of KILL_CMD register is 0b
 - either of the following conditions is met :
 - the value of UNTR_CMD register is 1b
 - the value of UNTR_DFT register is 01b
 - the value of UNTR_DFT register is 10b with tamper loop closed
 - the value of UNTR_DFT register is 11b with tamper loop open

2. ST25TVxxxC boots in KILLED state when:
 - in RF field
 - the value of KILL_CMD register is 1b
3. ST25TVxxxC goes from UNTRACEABLE to READY state on a successful: ToggleUntraceable command requested in Non-addressed mode which sets UNTR_CMD register to 0b
4. ST25TVxxxC goes from READY/SELECTED/QUIET to UNTRACEABLE state on a successful ToggleUntraceable command requested in Addressed mode which sets UNTR_CMD register to 1b
5. ST25TVxxxC goes from READY/SELECTED/QUIET to KILLED state on a successful Kill command requested in Addressed mode which permanently sets KILL_CMD register to 1b

When the ST25TVxxxC boots in **UNTRACEABLE** state, the value of UID register is masked(except in the response to a ReadConfiguration request (FID=FEh, PID=01h) where the content of the UID register is always returned without masking.) with the Untraceable UID value specified in section 7.1 until it **returns to POWER-OFF state**,

When the ST25TVxxxC boots in **READY** state and enters the UNTRACEABLE state with an explicit ToggleUntraceable command, the value of UID register is masked with the Untraceable UID value specified in Section 7.1 Untraceable UID until it **leaves the UNTRACEABLE state**.

When the ST25TVxxxC enters the UNTRACEABLE state, then until it leaves the UNTRACEABLE state :

- the value of AFI register is masked with 00h
- the value of DSFID register is masked with 00h

Note: When UID and/or AFI registers are masked, the resulting values have to be used:

- in Mask_value and AFI parameters of requests with Inventory_flag=1b
- in UID parameter of requests with Inventory_flag=0b and Address_flag=1b

6.3 Timing definition

Note: The tolerance on a specific timing is $\pm 32/f_C$

t₁: VICC response delay for read-alike commands

For a read-alike command - example a command not invoking a programming of the EEPROM - the VICC waits for a time t₁ starting at the rising edge of the EOF in the request received from the VCD, before transmitting its response. Values of t₁ are given in Table 97. Timing values.

Figure 11. Read-alike frame exchange between VCD and ST25TVxxxC

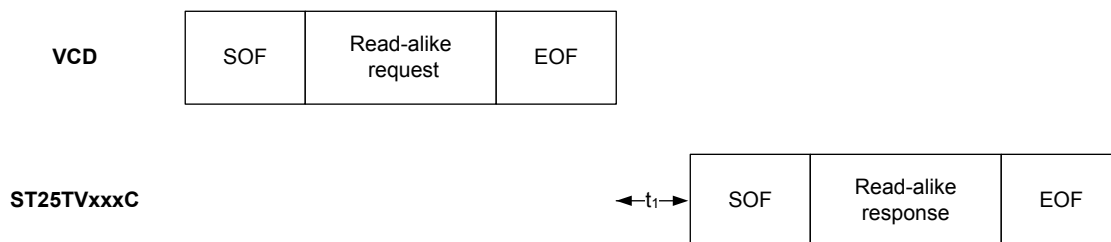

t₂: VCD new request delay

t₂ is the time after which the VCD may send an EOF to switch to the next slot when one or more VICC responses have been received after an Inventory request with Nb_slots_flag set to 0. It starts from the reception of the EOF from the VICCs.

The EOF sent by the VCD may be either 10% or 100% modulated regardless of the modulation index used for transmitting the VCD request to the VICC.

t_2 is also the time after which the VCD may send a new request to the VICC, as described in Figure 8. ISO15693 protocol timing.

Values of t_2 are given in Table 97. Timing values.

t_3 : VCD new request delay when no response is received from the VICC

t_3 is the time after which the VCD may send an EOF to switch to the next slot when no response has been received from the VICC after an Inventory request with Nb_slots_flag set to 0.

The EOF sent by the VCD may be either 10% or 100% modulated regardless of the modulation index used for transmitting the VCD request to the VICC.

Starting from the rising edge of the request EOF sent by the VCD:

- If this EOF is 100% modulated, the VCD waits for a time at least equal to t_{3min} for 100% modulation before sending a new EOF.
- If this EOF is 10% modulated, the VCD waits for a time at least equal to t_{3min} for 10% modulation before sending a new EOF.

Table 97. Timing values

-	Minimum (min) values		Nominal (nom) values	Maximum (max) values
	100% modulation	10% modulation		
t_1	4320 / $f_C = 318.6 \mu s$		4352 / $f_C = 320.9 \mu s$	4384 / $f_C = 323.3 \mu s^{(1)}$
t_2	4192 / $f_C = 309.2 \mu s$		No	No
t_3	$t_{1max}^{(2)} + t_{SOF}^{(3)}$	$t_{1max}^{(2)} + t_{NRT}^{(4)} + t_{2min}$	No t_{3nom}	No t_{3max}
t_{EOF}	10 ms	No	t_{EOFnom}	20 ms

1. VCD request will not be interpreted during the first milliseconds following the field rising.
2. t_{1max} does not apply for write-alike commands. Specific timing constraints for write-alike commands are defined by W_t and t_{EOF} (see below)
3. t_{SOF} is the time taken by the VICC to transmit an SOF to the VCD. t_{SOF} depends on the response data rate: High data rate or Low data rate.
4. t_{NRT} is the nominal response time of the VICC. t_{NRT} depends on the response data rate, the subcarrier modulation mode, and the size of expected response frame.

W_t : VICC response delay for write-alike commands with Option_flag=0

For a write-alike command with option_flag=0, for instance a command involving a programming of the EEPROM, the VICC waits for a time W_t starting at the rising edge of the EOF in the request received from the VCD, before transmitting its response.

The W_t time is equal to $t_{1nom} + a \text{ multiple of } 4096 / f_C (= 302 \mu s)$.

Figure 12. Write-alike frame exchange between VCD and ST25TVxxxC when Option_flag=0

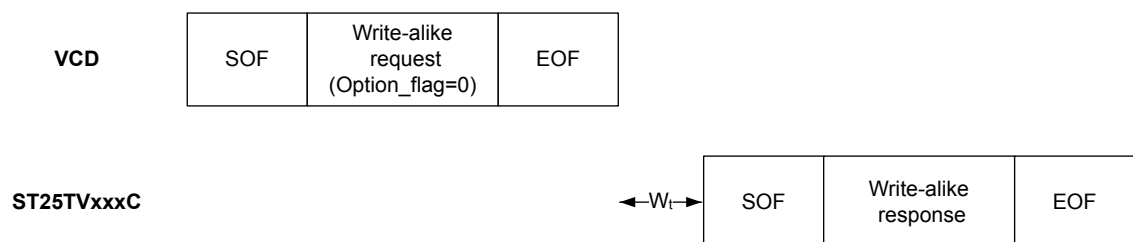

t_{EOF} : EOF request delay for write-alike commands with Option_flag=1

For a write-alike command with Option_flag=1, the VCD waits for a time t_{EOF} starting at the rising edge of the EOF in the request frame, before sending an isolated EOF request which triggers the response of the VICC. Upon reception of the isolated EOF request, the VICC waits for a time t_1 starting at the rising edge of the isolated EOF request, before transmitting its response.

Authorized values of t_{EOF} are given in [Table 97. Timing values.](#)

Figure 13. Write-alike frame exchange between VCD and ST25TVxxxC when Option_flag=1

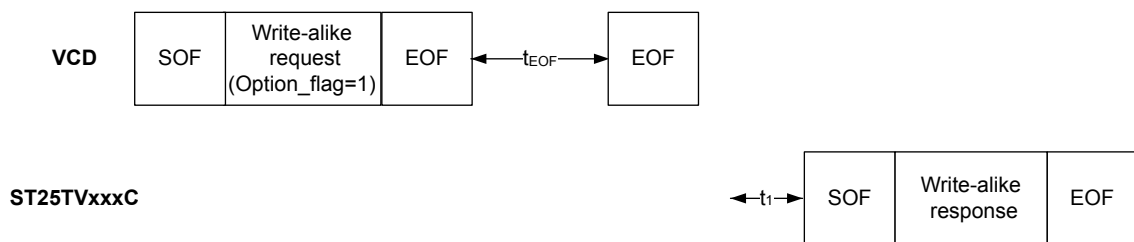

6.4 RF commands

The ST25TVxxxC supports the following RF command set:

- **Inventory**, used to perform the anticollision sequence.
- **StayQuiet**, used to put the ST25TVxxxC in QUIET state, where it responds only to commands in Addressed mode.
- **ReadSingleBlock**, used to read the 32 bits of a block and its locking status.
- **WriteSingleBlock**, used to write and verify the new content for an update of a 32 bits block, provided that the write access is granted.
- **LockBlock**, used to permanently forbid the write access to the selected block.
- **ReadMultipleBlocks**, used to read the content of a range of blocks and their locking status.
- **Select**, used to put the ST25TVxxxC in SELECTED state. After this command, the ST25TVxxxC processes all commands requested with Select_flag set.
- **ResetToReady**, used to put the ST25TVxxxC in the READY state.
- **WriteAFI**, used to write an 8-bit value in the AFI register.
- **LockAFI**, used to lock the AFI register.
- **WriteDSFID**, used to write an 8-bit value in the DSFID register.
- **LockDSFID**, used to lock the DSFID register.
- **GetSystemInfo** and **ExtendedGetSystemInfo**, used to read the standard system information values.
- **GetMultipleBlockSecurityStatus**, used to read the security status of a range blocks.
- **ReadConfig**, used to read configuration registers.
- **WriteConfig**, used to write configuration registers.
- **Kill**, used to permanently deactivate the tag by entering the KILLED state.
- **WritePassword**, used to change password of an open security session.
- **PresentPassword**, used to open a security session.
- **GetRandomNumber**, used to generate a 16 bit number.
- **ToggleUntraceable**, used to enter or leave the UNTRACEABLE state.
- **Initiate**, used to set the Initiate_flag register to 1.
- **InventoryInitiated**, used to perform the anticollision sequence on ST25TVxxxC with Initiate_flag set to 1.

Their codes are given in [Table 98](#).

Table 98. Command code

Opcode	Command	Opcode	Command
01h	Inventory	2Bh	GetSystemInfo
02h	StayQuiet	2Ch	GetMultipleBlockSecurityStatus
20h	ReadSingleBlock	3Bh	ExtendedGetSystemInfo
21h	WriteSingleBlock	A0h	ReadConfig
22h	LockBlock	A1h	WriteConfig
23h	ReadMultipleBlocks	A6h	Kill
25h	Select	B1h	WritePassword
26h	ResetToReady	B3h	PresentPassword
27h	WriteAFI	B4h	GetRandomNumber
28h	LockAFI	BAh	ToggleUntraceable
29h	WriteDSFID	D1h	InventoryInitiated
2Ah	LockDSFID	D2h	Initiate

6.4.1 Inventory

When receiving the Inventory request, the ST25TVxxxC sends a response if the parameters match the values of the UID and AFI registers.

Inventory_flag is set to 1 : bits 4 and 5 of Request_flags respectively code AFI_flag and Nb_slots_flag.

Option_flag is set to 0 : no option supported.

Table 99. Inventory request format

SOF	Request_flags	Opcode	AFI ⁽¹⁾	Mask_length	Mask_value	CRC_B	EOF
-	00xx01xxb	01h	8 bits	8 bits	0-64 bits	16 bits	-

1. AFI field present when Request_flags=00x101xxb

Request parameters and data include :

- AFI parameter if AFI_flag is set to 1
- Mask_length in bits, ≤ 60 when Nb_slots_flag = 0b, ≤ 64 when Nb_slots_flag = 1b
- Mask_value, size in bytes is (Mask_length + 7)/8, not present if Mask_length = 00h

Table 100. Inventory response format

SOF	Response_flags	DSFID	UID	CRC_B	EOF
-	00h	8 bits	64 bits	16 bits	-

When Error_flag is set to 0, response data include :

- DSFID register value
- UID register value

The ST25TVxxxC does not generate any answer in case of error.

When the VICC responds to an Inventory request, the timing of the frame exchange is that of a read-alike command as depicted in [Figure 11. Read-alike frame exchange between VCD and ST25TVxxxC.](#)

When Nb_slots_flag is set to 0, the VCD issues 15 EOF requests after the initial request from [Table 99. Inventory request format](#), with the following timings described in [Section 6.3 Timing definition](#):

- if the VICC responds to an EOF request, the timing of the frame exchange is that of a readalike command
- if the VCD receives a response from one or more VICCs, it waits for a time t_2 before sending the next EOF request
- if the VCD does not receive a response from any VICC, it waits for a time t_3 before sending the next EOF request

6.4.2 StayQuiet

When receiving the StayQuiet request:

- the ST25TVxxxC enters the QUIET state if no error occurs, and does NOT send back a response.
- there is NO response to the StayQuiet command even if an error occurs.

Select_flag is set to 0 and Address_flag is set to 1 : the StayQuiet request must be issued in Addressed mode.

Option_flag is set to 0 : no option supported.

Table 101. StayQuiet request format

SOF	Request_flags	Opcode	UID	CRC_B	EOF
-	001000xxb	02h	64 bits	16 bits	-

Request parameters and data include :

- UID parameter

When in QUIET state:

- the ST25TVxxxC does not process any request if Inventory_flag is set to 1,
- the ST25TVxxxC processes only requests with Address_flag set to 1.

The ST25TVxxxC exits the QUIET state:

- when it is reset (power off).
- on a successful Select request, it then goes to the SELECTED state.
- on a successful ResetToReady request, it then goes to the READY state.

Figure 14. Stay Quiet frame

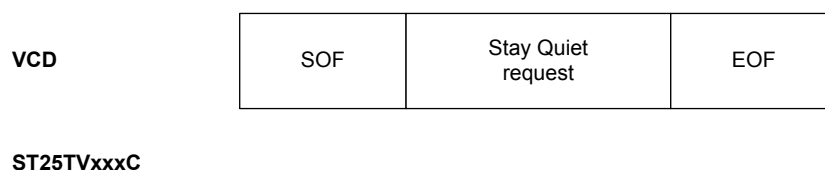

6.4.3 ReadSingleBlock

When receiving the ReadSingleBlock request, the ST25TVxxxC reads the requested block and sends back its 32-bit value in the response.

ReadSingleBlock command is applicable and successful, if and only if the requested block is available and has granted read access (ie, parent area not protected in Read or security session open).

When Option_flag is set to 1, the Block Security Status of the requested block is included in the response.

Table 102. ReadSingleBlock request format

SOF	Request_flags	Opcode	UID ⁽¹⁾	Block_number	CRC_B	EOF
-	0xxx00xxb	20h	64 bits	8 bits	16 bits	-

1. UID field present when Request_flags=0x1000xxb

Request parameters and data include :

- UID parameter if Address_flag is set to 1
- Block_number coded on 1 byte

Table 103. ReadSingleBlock response format when Error_flag equals 0

SOF	Response_flags	BSS ⁽¹⁾	Data	CRC_B	EOF
-	00h	8 bits	32 bits	16 bits	-

1. BSS field present when Request_flags=01xx00xxb.

When Error_flag is set to 0, response data include :

- Block security status if Option_flag is set to 1 (see Table 31. Block security status)
- Four bytes of block data

Note: The Data field from Table 103 may be impacted by the ANDEF feature (see Section 5.4.2 Augmented NDEF description)

When Error_flag is set to 1, Error_code field may take the values of Table 104 in a ReadSingleBlock response.

Table 104. ReadSingleBlock error codes when Error_flag equals 1

Error code	Description
02h	Invalid request format
03h	Invalid Request_flags value
10h	Requested block not available
15h	Read access to requested block is protected and security session is closed

When the VICC responds to a ReadSingleBlock request, the timing of the frame exchange is that of a read-alike command as depicted in Figure 11. Read-alike frame exchange between VCD and ST25TVxxxC.

6.4.4 WriteSingleBlock

When receiving the WriteSingleBlock request, the ST25TVxxxC writes the data contained in the request to the targeted block and reports whether the write operation was successful in the response.

WriteSingleBlock command is applicable and successful, if and only if the requested block is available and has granted write access (ie, the block is not locked, area not protected in Write or security session open).

When Option_flag is set to 1, the response is postponed to the subsequent EOF request.

Table 105. WriteSingleBlock request format

SOF	Request_flags	Opcode	UID ⁽¹⁾	Block_number	Data	CRC_B	EOF
-	0xxx00xxb	21h	64 bits	8 bits	32 bits	16 bits	-

1. UID field present when Request_flags=0x1000xxb

Request parameters and data include :

- UID parameter if Address_flag is set to 1
- Block_number coded on 1 byte
- Four bytes of block data

Note: The Data field from Table 105 is not impacted by the ANDEF feature (see Section 5.4.2 Augmented NDEF description)

Table 106. WriteSingleBlock response format when Error_flag equals 0

SOF	Response_flags	CRC_B	EOF
-	00h	16 bits	-

When Error_flag is set to 0, no data is inserted between the Response_flags and CRC_B fields.

When Error_flag is set to 1, Error_code field may take the values of Table 107 in a WriteSingleBlock response.

Table 107. WriteSingleBlock error codes when Error_flag equals 1

Error code	Description
02h	Invalid request format
03h	Invalid Request_flags value
10h	Requested block not available
12h	Write access to requested block is protected and security session is closed
13h	Programming of requested block failed

When the VICC responds to a WriteSingleBlock request, the timing of the frame exchange is that of a write-alike command as depicted in Figure 12 and Figure 13.

During the RF write cycle W_t , there should be no modulation (neither 100% nor 10%), otherwise the ST25TVxxxC may not correctly program the data into the memory.

6.4.5 LockBlock

When receiving the LockBlock request, the ST25TVxxxC locks the corresponding block value permanently to protect its content against new writing.

LockBlock command is applicable and successful, if and only if the requested block is available and has granted write access (ie, the block is not locked, area not protected in Write or security session open).

When Option_flag is set to 1, the response is postponed to the subsequent EOF request.

Table 108. LockBlock request format

SOF	Request_flags	Opcode	UID ⁽¹⁾	Block_number	CRC_B	EOF
-	0xxx00xxb	22h	64 bits	8 bits	16 bits	-

1. UID field present when Request_flags = 0x1000xxb

Request parameters and data include :

- UID parameter if Address_flag is set to 1
- Block_number coded on 1 byte

Table 109. LockBlock response format when Error_flag equals 0

SOF	Response_flags	CRC_B	EOF
-	00h	16 bits	-

When Error_flag is set to 0, no data is inserted between the Response_flags and CRC_B fields.

When Error_flag is set to 1, Error_code field may take the values of Table 110 in a LockBlock response.

Table 110. LockBlock error codes when Error_flag equals 1

Error code	Description
02h	Invalid request format
03h	Invalid Request_flags value
10h	Requested block not available
11h	Requested block is already locked
12h	Write access to requested block is protected and security session is closed
14h	Lock of requested block failed

When the VICC responds to a LockBlock request, the timing of the frame exchange is that of a write-alike command as depicted in Figure 12 and Figure 13.

During the RF write cycle W_t , there should be no modulation (neither 100% nor 10%), otherwise the ST25TVxxxC may not correctly program the LCK_BLOCK register into the memory.

6.4.6 ReadMultipleBlocks

When receiving the ReadMultipleBlocks request, the ST25TVxxxC reads the selected blocks and sends back their value in multiples of 32 bits in the response.

ReadMultipleBlocks command is applicable and successful, if and only if the first block requested is available and has granted read access (ie, parent area not protected in Read or security session open).

When the requested range of blocks ends beyond the user memory or in an area without read access authorized, the range of blocks used for the response data is truncated before the first block not available / not readable.

When Option_flag is set to 1, the Block Security Status of the blocks read are included in the response.

Table 111. ReadMultipleBlocks request format

SOF	Request_flags	Opcode	UID ⁽¹⁾	Block_number	Additional_blocks	CRC_B	EOF
-	0xxx00xxb	23h	64 bits	8 bits	8 bits	16 bits	-

1. UID field present when Request_flags=0x1000xxb

Request parameters and data include :

- UID parameter if Address_flag is set to 1
- Block_number coded on 1 byte, requested range of blocks starts at Block_number
- Additional_blocks coded on 1 byte, requested range of blocks ends at Block_number + Additional_blocks

Table 112. ReadMultipleBlocks response format when Error_flag equals 0

SOF	Response_flags	BSS ⁽¹⁾	Data	CRC_B	EOF
-	00h	8 bits ⁽²⁾	32 bits ⁽²⁾	16 bits	-

1. BSS field present when Request_flags=01xx00xxb

2. Repeated as needed

When Error_flag is set to 0, response data include for each block :

- Block security status if Option_flag is set to 1 (see Table 31. Block security status)
- Four bytes of block data

Note:

The Data field from Table 112 may be impacted by the ANDEF feature (see Section 5.4.2 Augmented NDEF description)

When Error_flag is set to 1, Error_code field may take the values of Table 113 in a ReadMultipleBlocks response.

Table 113. ReadMultipleBlocks error codes when Error_flag equals 1

Error code	Description
02h	Invalid request format
03h	Invalid Request_flags value
10h	Requested block not available
15h	Read access to requested block is protected and security session is closed

When the VICC responds to a ReadMultipleBlocks request, the timing of the frame exchange is that of a read-alike command as depicted in Figure 11. Read-alike frame exchange between VCD and ST25TVxxxC.

6.4.7

Select

When receiving the Select request:

- If the UID parameter matches its own UID, the ST25TVxxxC enters or stays in the SELECTED state and sends a response.
- If the UID parameter does not match its own UID, the selected ST25TVxxxC returns to the READY state and does not send a response.
- If an error occurs, the ST25TVxxxC remains in its current state.

Select_flag is set to 0 and Address_flag is set to 1 : the Select request must be issued in Addressed mode.

Option_flag is set to 0 : no option supported.

Table 114. Select request format

SOF	Request_flags	Opcode	UID	CRC_B	EOF
-	001000xxb	25h	64 bits	16 bits	-

Request parameters and data include :

- UID parameter

Table 115. Select response format when Error_flag equals 0

SOF	Response_flags	CRC_B	EOF
-	00h	16 bits	-

- When Error_flag is set to 0, no data is inserted between the Response_flags and CRC_B fields.
- When Error_flag is set to 1, Error_code field may take the values of [Table 116](#) in a Select response.

Table 116. Select error codes when Error_flag equals 1

Error code	Description
02h	Invalid request format
03h	Invalid Request_flags value

When the VICC responds to a Select request, the timing of the frame exchange is that of a read-alike command as depicted in [Figure 11. Read-alike frame exchange between VCD and ST25TVxxxC](#).

6.4.8

ResetToReady

When receiving the ResetToReady request:

- the ST25TVxxxC enters or stays in the READY state if no error occurs.
- in SELECTED state, the ST25TVxxxC responds an error when Addressed mode is used.
- in QUIET state, the ST25TVxxxC handles the request even if Non-addressed mode is used.
- If an error occurs, the ST25TVxxxC remains in its current state.

Option_flag is set to 0 : no option supported.

Table 117. ResetToReady request format

SOF	Request_flags	Opcode	UID ⁽¹⁾	CRC_B	EOF
-	00xx00xxb	26h	64 bits	16 bits	-

1. UID field present when Request_flags=0x1000xxb

Request parameters and data include:

- UID parameter if Address_flag is set to 1

Table 118. ResetToReady response format when Error_flag equals 0

SOF	Response_flags	CRC_B	EOF
-	00h	16 bits	-

When Error_flag is set to 0, no data is inserted between the Response_flags and CRC_B fields.

When Error_flag is set to 1, Error_code field may take the values of [Table 119](#) in a ResetToReady response.

Table 119. ResetToReady error codes when Error_flag equals 1

Error code	Description
02h	Invalid request format
03h	Invalid Request_flags value

When the VICC responds to a ResetToReady request, the timing of the frame exchange is that of a read-alike command as depicted in [Figure 11. Read-alike frame exchange between VCD and ST25TVxxxC.](#)

6.4.9 WriteAFI

When receiving the WriteAFI request, the ST25TVxxxC programs the 8-bit AFI register.

WriteAFI command is applicable and successful, if and only if the WriteAFI command is allowed (ie, AFI is not locked, AFI_PROT=0b or AREA1 security session open).

When Option_flag is set to 1, the response is postponed to the subsequent EOF request.

Table 120. WriteAFI request format

SOF	Request_flags	Opcode	UID ⁽¹⁾	AFI	CRC_B	EOF
-	0xxx00xxb	27h	64 bits	8 bits	16 bits	-

1. UID field present when Request_flags=0x1000xxb

Request parameters and data include:

- UID parameter if Address_flag is set to 1
- AFI parameter coded on 1 byte, used to program the AFI register

Table 121. WriteAFI response format when Error_flag equals 0

SOF	Response_flags	CRC_B	EOF
-	00h	16 bits	-

When Error_flag is set to 0, no data is inserted between the Response_flags and CRC_B fields.

When Error_flag is set to 1, Error_code field may take the values of [Table 122](#) in a WriteAFI response.

Table 122. WriteAFI error codes when Error_flag equals 1

Error code	Description
02h	Invalid request format
03h	Invalid Request_flags value
12h	LCK_AFI=1b or (AFI_PROT=1b and AREA1 security session is closed)
13h	Programming of AFI register failed

When the VICC responds to a WriteAFI request, the timing of the frame exchange is that of a write-alike command as depicted in [Figure 12](#) and [Figure 13](#).

During the RF write cycle Wt, there should be no modulation (neither 100% nor 10%), otherwise the ST25TVxxxC may not correctly program the AFI register into the memory.

6.4.10 LockAFI

When receiving the LockAFI request, the ST25TVxxxC locks the AFI register permanently.

LockAFI command is applicable and successful, if and only if the LockAFI command is allowed (ie, AFI not already locked, AFI_PROT=0b or AREA1 security session open).

When Option_flag is set to 1, the response is postponed to the subsequent EOF request.

Table 123. LockAFI request format

SOF	Request_flags	Opcode	UID ⁽¹⁾	CRC_B	EOF
-	0xxx00xxb	28h	64 bits	16 bits	-

1. UID field present when Request_flags=0x1000xxb

Request parameters and data include :

- UID parameter if Address_flag is set to 1

Table 124. LockAFI response format when Error_flag equals 0

SOF	Response_flags	CRC_B	EOF
-	00h	16 bits	-

When Error_flag is set to 0, no data is inserted between the Response_flags and CRC_B fields.

When Error_flag is set to 1, Error_code field may take the values of Table 125 in a LockAFI response.

Table 125. LockAFI error codes when Error_flag equals 1

Error code	Description
02h	Invalid request format
03h	Invalid Request_flags value
11h	LCK_AFI=1b : Successful LockAFI command already occurred
12h	AFI_PROT=1b and AREA1 security session is closed
14h	Programming of LCK_AFI register failed

When the VICC responds to a LockAFI request, the timing of the frame exchange is that of a write-alike command as described in Figure 12 and Figure 13.

During the RF write cycle Wt, there should be no modulation (neither 100% nor 10%), otherwise the ST25TVxxxC may not correctly program the LCK_AFI register into the memory.

6.4.11

WriteDSFID

When receiving the WriteDSFID request, the ST25TVxxxC programs the 8-bit DSFID register. WriteDSFID command is applicable and successful, if and only if the DSFID register is not locked (LCK_DSFIID=0b).

When Option_flag is set to 1, the response is postponed to the subsequent EOF request.

Table 126. WriteDSFID request format

SOF	Request_flags	Opcode	UID ⁽¹⁾	DSFID	CRC_B	EOF
-	0xxx00xxb	29h	64 bits	8 bits	16 bits	-

1. UID field present when Request_flags=0x1000xxb

Request parameters and data include:

- UID parameter if Address_flag is set to 1.
- DSFID parameter coded on 1 byte, used to program the DSFID register

Table 127. WriteDSFID response format when Error_flag equals 0

SOF	Response_flags	CRC_B	EOF
-	00h	16 bits	-

When Error_flag is set to 0, no data is inserted between the Response_flags and CRC_B fields.

When Error_flag is set to 1, Error_code field may take the values of Table 128 in a WriteDSFID response.

Table 128. WriteDSFID error codes when Error_flag equals 1

Error code	Description
02h	Invalid request format
03h	Invalid Request_flags value
12h	LCK_DSFDID=1b : DSFID register is locked
13h	Programmation of DSFID register failed

When the VICC responds to a WriteDSFID request, the timing of the frame exchange is that of a write-alike command as described in [Figure 12](#) and [Figure 13](#).

During the RF write cycle W_t , there should be no modulation (neither 100% nor 10%), otherwise the ST25TVxxxC may not correctly program the DSFID register into the memory.

6.4.12 LockDSFID

When receiving the LockDSFID request, the ST25TVxxxC locks the DSFID register permanently. LockDSFID command is applicable and successful, if and only if the DSFID register is not already locked (LCK_DSFDID=0b).

When Option_flag is set to 1, the response is postponed to the subsequent EOF request.

Table 129. LockDSFID request format

SOF	Request_flags	Opcode	UID ⁽¹⁾	CRC_B	EOF
-	0xxx00xxb	2Ah	64 bits	16 bits	-

1. UID field present when Request_flags=0x1000xxb

Request parameters and data include:

- UID parameter if Address_flag is set to 1

Table 130. LockDSFID response format when Error_flag equals 0

SOF	Response_flags	CRC_B	EOF
-	00h	16 bits	-

When Error_flag is set to 0, no data is inserted between the Response_flags and CRC_B fields.

When Error_flag is set to 1, Error_code field may take the values of [Table 131](#) in a LockDSFID response.

Table 131. LockDSFID error codes when Error_flag equals 1

Error code	Description
02h	Invalid request format
03h	Invalid Request_flags value
11h	LCK_DSFDID=1b : Successful LockDSFID command already occurred
14h	Programmation of LCK_DSFDID register failed

When the VICC responds to a LockDSFID request, the timing of the frame exchange is that of a write-alike command as depicted in [Figure 12](#) and [Figure 13](#).

During the RF write cycle W_t , there should be no modulation (neither 100% nor 10%), otherwise the ST25TVxxxC may not correctly program the LCK_DSFDID register into the memory.

6.4.13 GetSystemInfo

When receiving the GetSystemInfo request, the ST25TVxxxC sends back its information data in the response.

Option_flag is set to 0 : no option supported.

Table 132. GetSystemInfo request format

SOF	Request_flags	Opcode	UID ⁽¹⁾	CRC_B	EOF
-	00xx00xxb	2Bh	64 bits	16 bits	-

1. UID field present when Request_flags=0x1000xxb

Request parameters and data include:

- UID parameter if Address_flag is set to 1

Table 133. GetSystemInfo response

SOF	Response_flags	Information_flags	UID	DSFID	AFI	Memory_size	IC_ref	CRC_B	EOF
-	00h	0Fh	64 bits	8 bits	8 bits	16 bits	08h	16 bits	-

When Error_flag is set to 0, response data include :

- Information_flags coded on 1 byte, set to 0Fh (DSFID, AFI, Memory_size and IC_ref fields are all present).
- UID register value
- DSFID register value
- AFI register value
- Memory_size coded on 2 bytes:
 - 8-MSB (03h) = Block size in number of Bytes - 1
 - 8-LSB (END_MEM) = User memory size in number of Blocks - 1
- IC_REF register value

When Error_flag is set to 1, Error_code field may take the values of [Table 134](#) in a GetSystemInfo response.

Table 134. GetSystemInfo error codes when Error_flag equals 1

Error code	Description
02h	Invalid request format
03h	Invalid Request_flags value

When the VICC responds to a GetSystemInfo request, the timing of the frame exchange is that of a read-alike command as depicted in [Figure 11](#).

6.4.14 GetMultipleBlockSecurityStatus

When receiving the GetMultipleBlockSecurityStatus request, the ST25TVxxxC responds the block security status of the selected blocks.

GetMultipleBlockSecurityStatus command is applicable and successful, if and only if the first block requested is available.

When the requested range of blocks ends beyond the user memory, the range of blocks used for the response data is truncated to the last block available.

Option_flag is set to 0 : no option supported.

Table 135. GetMultipleBlockSecurityStatus request format

SOF	Request_flags	Opcode	UID ⁽¹⁾	Block_number	Additional_blocks	CRC_B	EOF
-	00xx00xxb	2Ch	64 bits	8 bits	8 bits	16 bits	-

1. UID field present when Request_flags=0x1000xxb

Request parameters and data include :

- UID parameter if Address_flag is set to 1

- Block_number coded on 1 byte, requested range of blocks starts at Block_number
- Additional_blocks coded on 1 byte, requested range of blocks ends at Block_number + Additional_blocks

Table 136. GetMultipleBlockSecurityStatus response format when Error_flag equals 0

SOF	Response_flags	BSS	CRC_B	EOF
-	00h	8 bits ⁽¹⁾	16 bits	-

1. Repeated as needed

When Error_flag is set to 0, response data include for each block :

- Block security status (see Table 31. Block security status)

When Error_flag is set to 1, Error_code field may take the values of Table 137 in a GetMultipleBlockSecurityStatus response.

Table 137. GetMultipleBlockSecurityStatus error codes when Error_flag equals 1

Error code	Description
02h	Invalid request format
03h	Invalid Request_flags value
10h	Requested block not available

When the VICC responds to a GetMultipleBlockSecurityStatus request, the timing of the frame exchange is that of a read-alike command as depicted in Figure 11.

6.4.15

ExtendedGetSystemInfo

When receiving the ExtendedGetSystemInfo request, the ST25TVxxxC sends back its information data in the response.

Option_flag is set to 0 : no option supported.

Table 138. ExtendedGetSystemInfo request format

SOF	Request_flags	Opcode	Information_request_list	UID ⁽¹⁾	CRC_B	EOF
-	00xx00xxb	3Bh	0xx1xxxxb	64 bits	16 bits	-

1. UID field present when Request_flags=0x1000xxb

Request parameters and data include :

- Information_request_list parameter coded on 1 byte, see Table 139 below
- UID parameter if Address_flag is set to 1

Table 139. Information_request_list content

Bit	Requested information	Description
b0	DSFID	0: DSFID not requested 1: DSFID requested
b1	AFI	0: AFI not requested 1: AFI requested
b2	Memory_size	0: VICC memory size not requested 1: VICC memory size requested
b3	IC_ref	0: IC reference not requested

Bit	Requested information	Description
		1: IC reference requested
b4	MOI	1: Information on MOI always returned in response flag
b5	Command_list	0: list of supported commands not requested 1: list of supported commands requested
b6	CSI information	0: CSI list not requested 1: CSI list requested
b7	Ext_list	0: size of Information_request_list is 1 byte

Table 140. ExtendedGetSystemInfo response format when Error_flag equals 0

SOF	Response_flags	Information_flags	UID	Information_fields	CRC_B	EOF
-	00h	00x0xxxxb	64 bits	up to 80 bits	16 bits	-

Table 141. Information_flags content

Bit	Responded information	Description
b0	DSFID	0: DSFID not present in Information_fields 1 : DSFID present in Information_fields
b1	AFI	0: AFI not present in Information_fields 1: AFI present in Information_fields
b2	Memory_size	0: Memory_size not present in Information_fields 1: Memory_size present in Information_fields
b3	IC_ref	0: IC_ref not present in Information_fields 1: IC_ref present in Information_fields
b4	MOI	0: 1 byte addressing
b5	Command_list	0: Command_list not present in Information_fields 1: Command_list present in Information_fields
b6	CSI_information	0: CSI list not present
b7	Ext_info	0: size of Information_flags is 1 byte

Table 142. Information_fields content

DSFID ⁽¹⁾	AFI ⁽¹⁾	Memory_size ⁽¹⁾	IC_ref ⁽¹⁾	Command_list ⁽¹⁾
8 bits	8 bits	24 bits	08h	00003FEFh

1. Presence of information fields depends on value of Information_flags

When Error_flag is set to 0, response data include :

- Information_flags coded on 1 byte, defining which fields are present (see Table 141)
- UID register value
- DSFID register value, present if Information_flags[0]=1b
- AFI register value, present if Information_flags[1]=1b
- VICC Memory size coded on 3 bytes, present if Information_flags[2]=1b
 - 8-MSB (03h) = Block size in number of Bytes - 1
 - 16-LSB (END_MEM) = User memory size in number of Blocks - 1
- IC_REF register value, present if Information_flags[3]=1b

- VICC Command list coded on 4 bytes, present if Information_flags[5]=1b

When Error_flag is set to 1, Error_code field may take the values of Table 143 in an ExtendedGetSystemInfo response.

Table 143. ExtendedGetSystemInfo error codes when Error_flag equals 1

Error code	Description
02h	Invalid request format
03h	Invalid Request_flags or Information_request_list value

When the VICC responds to an ExtendedGetSystemInfo request, the timing of the frame exchange is that of a read-alike command as depicted in Figure 11.

6.4.16 ReadConfiguration

When receiving the ReadConfiguration request, the ST25TVxxxC reads the selected configuration register and sends back its value in the response.

ReadConfiguration command is applicable and successful, if and only if the requested configuration register (identified by the FID/PID pair) is available and has granted read access (i.e. read not protected, or feature not locked and CONFIG security session open).

Option_flag is set to 0 : no option supported.

Table 144. ReadConfiguration request format

SOF	Request_flags	Opcode	IC Mfg code	UID ⁽¹⁾	FID	PID	CRC_B	EOF
-	00x00xxb	A0h	02h	64 bits	8 bits	8 bits	16 bits	-

1. UID field present when Request_flags=0x1000xxb

Request parameters and data include :

- IC manufacturer code coded on 1 byte, value shall be 02h
- UID parameter if Address_flag is set to 1
- FID parameter coded on 1 byte
- PID parameter coded on 1 byte

Table 145. ReadConfiguration response format when Error_flag equals 0

SOF	Response_flags	Data ⁽¹⁾	CRC_B	EOF
-	00h	8 to 64 bits	16 bits	-

1. Size of data responded depends on the requested FID and PID values according to Table 4. List of configuration registers

When Error_flag is set to 0, response data include :

- Configuration register value coded on 1 to 8 bytes depending on the requested FID/PID pair (see Table 4. List of configuration registers)

Note:

When a register value is coded on several bytes, it is transmitted in LSB to MSB byte order in the response to a ReadConfiguration request.

When Error_flag is set to 1, Error_code field may take the values of Table 146 in a ReadConfiguration response.

Table 146. ReadConfiguration error codes when Error_flag equals 1

Error code	Description
01h	Invalid IC Mfg code value

Error code	Description
02h	Invalid request format
03h	Invalid Request_flags value
10h	Requested FID/PID not available
15h	Read access to requested FID/PID is protected and CONFIG security session is closed

When the VICC responds to a ReadConfiguration request, the timing of the frame exchange is that of a read-alike command as depicted in [Figure 11](#).

6.4.17 WriteConfiguration

When receiving the WriteConfiguration request, the ST25TVxxxC writes the data contained in the request to the selected configuration register and responds an acknowledgement if the write operation was successful.

WriteConfiguration command is applicable and successful, if and only if the requested configuration register (identified by the FID/PID pair) is available and has granted write access (i.e. feature not locked and CONFIG security session open).

When Option_flag is set to 1, the response is postponed to the subsequent EOF request.

Table 147. WriteConfiguration request format

SOF	Request_flags	Opcode	IC Mfg code	UID ⁽¹⁾	FID	PID	Data	CRC_B	EOF
-	0xxx00xxb	A1h	02h	64 bits	8 bits	8 bits	8-32 bits	16 bits	-

1. UID field present when Request_flags=0x1000xxb

Request parameters and data include :

- IC manufacturer code coded on 1 byte, value shall be 02h
- UID parameter if Address_flag is set to 1
- FID parameter coded on 1 byte
- PID parameter coded on 1 byte
- New register value coded on 1 to 4 bytes depending on the requested FID/PID pair (see [Table 4. List of configuration registers](#))

Note: When a register value is coded on several bytes, it is transmitted in LSB to MSB byte order in the WriteConfiguration request.

Table 148. WriteConfiguration response format when Error_flag equals 0

SOF	Response_flags	CRC_B	EOF
-	00h	16 bits	-

When Error_flag is set to 0:

- no data is inserted between the Response_flags and CRC_B fields.
- the update of the register value into the memory is successful, and the new value is immediately readable with a ReadConfiguration request. However the effect of the new value may be active immediately or on the next RF boot sequence depending on the selected configuration (see column Activation time of [Table 4. List of configuration registers](#)).

When the effect of a new configuration register value is activated on the next RF boot sequence, the effect of the former configuration value lasts after the update of the register into the memory until the ST25TVxxxC is put in POWER-OFF state.

When Error_flag is set to 1, Error_code field may take the values of [Table 149](#) in a WriteConfiguration response.

Table 149. WriteConfiguration error codes when Error_flag equals 1

Error code	Description
01h	Invalid IC Mfg code value
02h	Invalid request format
03h	Invalid Request_flags value
10h	Requested FID/PID not available
11h	Bit of LCK_CONFIG (FID=FFh,PID=00h) already set to 1b
12h	Write access to requested FID/PID is protected and CONFIG security session is closed
13h	Programming of requested FID/PID (other than LCK_CONFIG) failed
14h	Programming of LCK_CONFIG (FID=FFh,PID=00h) failed

When the VICC responds to a WriteConfiguration request, the timing of the frame exchange is that of a write-alike command as depicted in [Figure 12](#) and [Figure 13](#).

During the RF write cycle W_t , there should be no modulation (neither 100% nor 10%), otherwise the ST25TVxxxC may not correctly program the configuration register into the memory.

6.4.18 WritePassword

When receiving the WritePassword request, the ST25TVxxxC uses the data contained in the request to modify the selected password and responds an acknowledgement if the write operation was successful.

WritePassword command is applicable and successful, if and only if it preceded by a successful PresentPassword command with same password selected. Refer to [Section 5.1.2 Password management](#) for details on password management.

When Option_flag is set to 1, the response is postponed to the subsequent EOF request.

Table 150. WritePassword request format

SOF	Request_flags	Opcode	IC Mfg code	UID ⁽¹⁾	Password_id	Password_data	CRC_B	EOF
-	0xxx00xxb	B1h	02h	64 bits	8 bits	32 or 64 bits	16 bits	-

1. UID field present when Request_flags=0x1000xxb

Request parameters and data include :

- IC manufacturer code coded on 1 byte, value shall be 02h
- UID parameter if Address_flag is set to 1
- Password_id coded on 1 byte
- Password_data coded on 4 or 8 bytes according to [Table 27. List of password registers](#)

The Password_data value is obtained from the encryption of the new plain value of the password as described in [Section 5.1.3 Password encryption](#).

Danger:

If a plain value is mistakenly used in the Password_data field of the WritePassword command, the presentation of its encrypted value with the PresentPassword command fails on the ST25TVxxxC device.

Note: *The behavior of the WritePassword command is different between the ST25TVxxx and ST25TVxxxC devices regarding the encryption of the Password_data field. The Password_data field is a plain password value on the ST25TVxxx device described in datasheet DS12074, while it is an encrypted password value on the ST25TVxxxC device described in this document.*

It is recommended to issue the WritePassword request in Addressed or Select mode, in order to improve the system robustness.

This ensures that password change is only applied to a specific tag/UID.

Table 151. WritePassword response format when Error_flag equals 0

SOF	Response_flags	CRC_B	EOF
-	00h	16 bits	-

When Error_flag is set to 0:

- no data is inserted between the Response_flags and CRC_B fields.
- the update of the password into the memory is successful, and the corresponding security session remains open.

When Error_flag is set to 1, Error_code field may take the values of [Table 152](#) in a WritePassword response.

Table 152. WritePassword error codes when Error_flag equals 1

Error code	Description
01h	Invalid IC Mfg code value
02h	Invalid request format, including case of invalid password size
03h	Invalid Request_flags value
10h	Invalid Password_id value
12h	Security session is closed
13h	Programming of requested password failed

When the VICC responds to a WritePassword request, the timing of the frame exchange is that of a write-alike command as depicted in [Figure 12](#) and [Figure 13](#).

During the RF write cycle W_t , there should be no modulation (neither 100% nor 10%), otherwise the ST25TVxxxC may not correctly program the password value into the memory.

There is no anti-tearing mechanism while operating the WritePassword command. Command should be applied with stable RF field, otherwise the write operation may not complete properly, and could imply a loss/corruption of password content.

The ST25TVxxxC offers a password recovery capability when such content loss/corruption occurs, see [Section 5.1.2 Password management](#).

6.4.19 PresentPassword

When receiving the PresentPassword request, the ST25TVxxxC compares the selected password register with the password coded in the request and responds an acknowledgment if the operation was successful.

After a successful PresentPassword command, the security session associated to the password is open as described in [Section 5.1 Data protection](#).

Option_flag is set to 0 : no option supported.

Table 153. PresentPassword request format

SOF	Request_flags	Opcode	IC Mfg code	UID ⁽¹⁾	Password_id	Password_data	CRC_B	EOF
-	00xx00xxb	B3h	02h	64 bits	8 bits	32 or 64 bits	16 bits	-

1. UID field present when Request_flags=0x1000xxb

Request parameters and data include :

- IC manufacturer code coded on 1 byte, value shall be 02h
- UID parameter if Address_flag is set to 1
- Password_id coded on 1 byte
- Password_data coded on 4 or 8 bytes according to [Table 27. List of password registers](#)

The unique valid Password_data value is obtained from the encryption of the plain password value as described in [Section 5.1.3 Password encryption](#).

It is recommended to issue the PresentPassword request in Addressed or Select mode, in order to improve the system robustness. This ensures that password presentation is only applied to a specific tag/UID.

Table 154. PresentPassword response format when Error_flag equals 0

SOF	Response_flags	CRC_B	EOF
-	00h	16 bits	-

When Error_flag is set to 0:

- no data is inserted between the Response_flags and CRC_B fields.
- the presentation of the password is successful, and the corresponding security session is open.

When Error_flag is set to 1, Error_code field may take the values of Table 155 in a PresentPassword response. All security sessions are closed if an invalid value of Password_data is presented.

Warning:

After the presentation of an invalid value of Password_data with the PresentPassword / Kill / ToggleUntraceable command, the GetRandomNumber command shall be called before attempting another password presentation with the PresentPassword command as described in Section 5.1.3 Password encryption.

The ST25TVxxxC offers a password attempt limit capability to protect a password against brute-force attacks, see Section 5.1.2 Password management.

Table 155. PresentPassword error codes when Error_flag equals 1

Error code	Description
01h	Invalid IC Mfg code value
02h	Invalid request format, including case of invalid password size
03h	Invalid Request_flags value
0Fh	Invalid Password_data value
10h	Invalid Password_id value

When the VICC responds to a PresentPassword request, the timing of the frame exchange is that of a read-alike command as depicted in Figure 11.

6.4.20

Kill

When receiving the Kill request, the ST25TVxxxC compares register PWD_CFG with the password coded in the request and responds an acknowledgment if the operation was successful.

Kill command is applicable if and only if the DIS_KILL register is set to 0b, otherwise it is ignored. After a successful Kill command, the ST25TVxxxC permanently enters the KILLED state, where it stays mute to any request.

Select_flag is set to 0 and Address_flag is set to 1 : the Kill request must be issued in Addressed mode.

When Option_flag is set to 1, the response is postponed to the subsequent EOF request.

Table 156. Kill request format

SOF	Request_flags	Opcode	IC Mfg code	UID	Password_id	Password_data	CRC_B	EOF
-	0x1000xxb	A6h	02h	64 bits	00h	32 bits	16 bits	-

Request parameters and data include :

- IC manufacturer code coded on 1 byte, value shall be 02h
- UID parameter

- Password_id coded on 1 byte, value shall be 00h
- Password_data coded on 4 bytes

The unique valid Password_data value is obtained from the encryption of the plain password value as described in [Section 5.1.3 Password encryption](#)

Warning:

After the presentation of an invalid value of Password_data with the PresentPassword / Kill / ToggleUntraceable command, the GetRandomNumber command shall be called before attempting another password presentation with the Kill command.

Note:

The behavior of the Kill command is different between the ST25TVxxx and ST25TVxxxC devices regarding the encryption of the Password_data field. The Password_data field is a plain password value on the ST25TVxxx device described in datasheet DS12074, while it is an encrypted password value on the ST25TVxxxC device described in this document.

Table 157. Kill response format when Error_flag equals 0

SOF	Response_flags	CRC_B	EOF
-	00h	16 bits	-

When Error_flag is set to 0:

- no data is inserted between the Response_flags and CRC_B fields.
- the ST25TVxxxC permanently enters the KILLED state by setting the KILL_CMD register to 1b.

When Error_flag is set to 1, Error_code field may take the values of [Table 158](#) in a Kill response.

Table 158. Kill error codes when Error_flag equals 1

Error code	Description
01h	Invalid IC Mfg code value
02h	Invalid request format
03h	Invalid Request_flags value
0Fh	Invalid Password_data value
10h	Invalid Password_id value
14h	Programming of KILL_CMD failed

When the VICC responds to a Kill request, the timing of the frame exchange is that of a write-alike command as depicted in [Figure 12](#) and [Figure 13](#).

During the RF write cycle W_t , there should be no modulation (neither 100% nor 10%), otherwise the ST25TVxxxC may not correctly program the KILL_CMD register into the memory.

6.4.21

Initiate

When receiving the Initiate request, the ST25TVxxxC sets the Initiate_flag register to 1b and sends back a response. Initiate_flag is automatically reset to 0b when the ST25TVxxxC enters the POWER-OFF state. Select_flag is set to 0 and Address_flag is set to 0 : the Initiate request must be issued in Non-addressed mode. Option_flag is set to 0 : no option supported.

Table 159. Initiate request format

SOF	Request_flags	Opcode	IC Mfg code	CRC_B	EOF
-	000000xxb	D2h	02h	16 bits	-

Request parameters and data include :

- IC manufacturer code coded on 1 byte, value shall be 02h

Table 160. Initiate response format when Error_flag equals 0

SOF	Response_flags	DSFID	UID	CRC_B	EOF
-	00h	8 bits	64 bits	16 bits	-

When Error_flag is set to 0, Initiate_flag is set to 1b response data include :

- DSFID register value
- UID register value

The ST25TVxxxC does not generate any answer in case of error.

When the VICC responds to an Initiate request, the timing of the frame exchange is that of a read- alike command as depicted in [Figure 11](#).

6.4.22

InventoryInitiated

When receiving the InventoryInitiated request, the ST25TVxxxC sends a response if Initiate_flag is set to 1b and the parameters match the values of the UID and AFI registers.

Inventory_flag is set to 1 : bits 4 and 5 of Request_flags respectively code AFI_flag and Nb_slots_flag.

Option_flag is set to 0 : no option supported.

Table 161. InventoryInitiated request format

SOF	Request_flags	Opcode	IC Mfg code	AFI ⁽¹⁾	Mask_length	Mask_value	CRC_B	EOF
-	00x01xxb	D1h	02h	8 bits	8 bits	0-64 bits	16 bits	-

1. AFI field present when Request_flags=00x101xxb

Request parameters and data include :

- IC manufacturer code coded on 1 byte, value shall be 02h
- AFI parameter if AFI_flag is set to 1
- Mask_length in bits, ≤ 60 when Nb_slots_flag = 0b, ≤ 64 when Nb_slots_flag = 1b
- Mask_value, size in bytes is (Mask_length + 7)/8, not present if Mask_length = 00h

Table 162. InventoryInitiated response format when Error_flag equals 0

SOF	Response_flags	DSFID	UID	CRC_B	EOF
-	00h	8 bits	64 bits	16 bits	-

When Error_flag is set to 0, response data include :

- DSFID register value
- UID register value

The ST25TVxxxC does not generate any answer in case of error.

When the VICC responds to an InventoryInitiated request, the timing of the frame exchange is that of a read-alike command as depicted in [Figure 11](#).

When Nb_slots_flag is set to 0, the VCD issues 15 EOF requests after the initial request from [Table 161](#), with the following timings described in [Section 6.3 Timing definition](#):

- if the VICC responds to an EOF request, the timing of the frame exchange is that of a read-alike command
- if the VCD receives a response from one or more VICCs, it waits for a time t2 before sending the next EOF request
- if the VCD does not receive a response from any VICC, it waits for a time t3 before sending the next EOF request

6.4.23 ToggleUntraceable

When receiving the ToggleUntraceable request, the ST25TVxxxC compares register PWD_UNTR with the password coded in the request and responds an acknowledgement if the operation was successful.

ToggleUntraceable command is applicable only in the following cases, otherwise it is ignored :

- the ST25TVxxxC is in READY, SELECTED or QUIET state, and the request is issued in Addressed mode (Select_flag=0, Address_flag=1)
- the ST25TVxxxC is in UNTRACEABLE state, and the request is issued in Non-Addressed mode (Select_flag=0, Address_flag=0)

After a successful ToggleUntraceable command, the ST25TVxxxC leaves or enters (depending on the addressing mode) the UNTRACEABLE state described in [Section 6.2.9 Custom states](#).

When Option_flag is set to 1, the response is postponed to the subsequent EOF request.

Table 163. ToggleUntraceable request format

SOF	Request_flags	Opcode	IC Mfg code	UID ⁽¹⁾	Password_id	Password_data	CRC_B	EOF
-	0xx000xxb	BAh	02h	64 bits	03h	32 bits	16 bits	-

1. UID field present when Request_flags=0x1000xxb

Request parameters and data include :

- IC manufacturer code coded on 1 byte, value shall be 02h
- UID parameter if Address_flag is set to 1
- Password_id coded on 1 byte, value shall be 03h
- Password_data coded on 4 bytes

The unique valid Password_data value is obtained from the encryption of the plain password value as described in section 5.1.3

Warning:

After the presentation of an invalid value of Password_data with the PresentPassword / Kill / ToggleUntraceable command, the GetRandomNumber command shall be called before attempting another password presentation with the ToggleUntraceable command as described in [Section 5.1.3 Password encryption](#).

Note:

Opcode value BAh is used for the EnableUntraceable command of the ST25TVxxx device described in datasheet DS12074. The EnableUntraceable command has the same request format as the ToggleUntraceable command, except for the value of the Password_id field which is 00h on the ST25TVxxx device, and 03h on the ST25TVxxxC device described in this document.

Table 164. ToggleUntraceable response format when Error_flag equals 0

SOF	Response_flags	CRC_B	EOF
-	00h	16 bits	-

When Error_flag is set to 0:

- no data is inserted between the Response_flags and CRC_B fields.
- if the request was issued in Addressed mode, the ST25TVxxxC enters the UNTRACEABLE state by setting the UNTR_CMD register to 1b.
- if the request was issued in Non-addressed mode, the ST25TVxxxC enters the READY state by setting the UNTR_CMD register to 0b.

When Error_flag is set to 1, Error_code field may take the values of [Table 165](#) in a ToggleUntraceable response.

Table 165. ToggleUntraceable error codes when Error_flag equals 1

Error code	Description
01h	Invalid IC Mfg code value
02h	Invalid request format
03h	Invalid Request_flags value
0Fh	Invalid Password_data value
10h	Invalid Password_id value
13h	Programming of UNTR_CMD failed

When the VICC responds to a ToggleUntraceable request, the timing of the frame exchange is that of a write-alike command as depicted in [Figure 12](#) and [Figure 13](#).

During the RF write cycle Wt , there should be no modulation (neither 100% nor 10%), otherwise the ST25TVxxxC may not correctly program the UNTR_CMD register into the memory.

6.4.24

GetRandomNumber

When receiving the GetRandomNumber request, the ST25TVxxxC responds a 16-bit random number.

When Option_flag is set to 1, the response is postponed to the subsequent EOF request.

Table 166. GetRandomNumber request format

SOF	Request_flags	Opcode	IC Mfg code	UID ⁽¹⁾	CRC_B	EOF
-	0xxx00xxb	B4h	02h	64 bits	16 bits	-

1. UID field present when Request_flags=0x1000xxb

Request parameters and data include :

- IC manufacturer code coded on 1 byte, value shall be 02h
- UID parameter if Address_flag is set to 1

Table 167. GetRandomNumber response format when Error_flag equals 0

SOF	Response_flags	RND_NUMBER	CRC_B	EOF
-	00h	16 bits	16 bits	-

When Error_flag is set to 0, a new 16-bit value has been programmed in the RND_NUMBER register, and response data include :

- RND_NUMBER register value

When Error_flag is set to 1, Error_code field may take the values of [Table 168](#) in a GetRandomNumber response.

Table 168. GetRandomNumber error codes when Error_flag equals 1

Error code	Description
01h	Invalid IC Mfg code value
02h	Invalid request format
03h	Invalid Request_flags value
13h	Programming of RND_NUMBER failed

When the VICC responds to a GetRandomNumber request, the timing of the frame exchange is that of a write-alike command as depicted in [Figure 12](#) and [Figure 13](#).

During the RF write cycle W_t , there should be no modulation (neither 100% nor 10%), otherwise the ST25TVxxxC may not correctly program the RND_NUMBER register into the memory.

7 Unique identifier (UID)

The ST25TVxxxC ICs are uniquely identified by a 64-bit unique identifier (UID). This UID complies with ISO/IEC 15693 and ISO/IEC 7816-6. The UID is a read-only code and comprises:

- 8 bytes
- magic number code E0h on 8 bits
- the IC manufacturer code “ST 02h” on 8 bits (ISO/IEC 7816-6/AM1)
- the ST25TVxxxC product code 08h on 8 bits
- a unique serial number on 40 bits

Table 169. UID format

MSB		LSB	
b63-b56	b55-b48	b47-b40	b39-b0
E0h	02h	ST product code : 08h	Unique serial number

7.1 Untraceable UID

When the ST25TVxxxC meets either of the following conditions :

- the current RF session started in UNTRACEABLE state
- the current state is UNTRACEABLE

then the UID register is masked with the content from [Table 170](#) when processing request and response frames of all commands, except in the response to a ReadConfiguration request (FID=FEh, PID=01h) where the content of the UID register is always returned without masking.

Table 170. Untraceable UID : UID value in UNTRACEABLE state

MSB		LSB	
b63-b56	b55-b48	b47-b40	b39-b0
E0h	02h	00h	0000000000h

Note: When several ST25TVxxxC tags responding UID from [Table 170](#) are present in the field of a VCD, it is not possible to discriminate them with an anticollision procedure. Only one ST25TVxxxC IC responding Untraceable UID value should be present in the field of a VCD for an application to work properly

8 Device parameters

8.1 Maximum ratings

Stressing the device above the ratings listed in Table 171. Absolute maximum ratings may permanently damage it. These are stress ratings only and operation of the device, at these or any other conditions above those indicated in the operating sections of this specification, is not implied. Exposure to absolute maximum rating conditions for extended periods may affect the device reliability. Refer also to the STMicroelectronics SURE Program and other relevant quality documents.

Table 171. Absolute maximum ratings

Symbol	Description	Min	Max	Unit
T_A	Ambient operating temperature	-40	85	°C
T_{STG_1}	Storage temperature for UDFPN5 package	-65	150	°C
T_{STG_2}	Storage temperature for sawn wafer ⁽¹⁾	15	25	°C
t_{STG}	Sawn wafer ⁽¹⁾ storage duration counted from ST production date	-	9	months
V_{MAX_1} ⁽²⁾	Max input voltage amplitude (peak to peak) between AC0 and AC1	-	11	V
V_{ESD}	Electronic discharge voltage ⁽³⁾ on all pins	-	2000	V

1. Sawn wafer on UV tape kept in its original packing form

2. (VAC0-VAC1) peak to peak characterized on bench

3. Human body model of ANSI/ESDA/JEDEC JS-001 with $C = 100\text{ pF}$, $R = 1500\ \Omega$, $R2 = 500\ \Omega$

8.2 RF electrical parameters

This section summarizes the operating and measurement conditions, and the RF electrical parameters of the device.

The parameters in the RF characteristics table that follows are derived from tests performed under the measurement conditions summarized in the relevant tables. Designers should check that the operating conditions in their circuit match the measurement conditions when relying on the quoted parameters.

Table 172. RF characteristics

Symbol	Description	Condition ⁽¹⁾⁽²⁾	Min	Typ	Max	Unit
f_{CC}	External RF signal frequency	-	13.553	13.56	13.567	MHz
f_{SL}	Low subcarrier frequency ($f_{CC}/32$)	-	-	423.75	-	kHz
f_{SH}	High subcarrier frequency ($f_{CC}/28$)	-	-	484.28	-	kHz
MI_{10}	10% carrier modulation index ⁽³⁾	150 mA/m < H < 5 A/m	10	-	30	%
MI_{100}	100% carrier modulation index ⁽³⁾	150 mA/m < H < 5 A/m	95	-	100	%
$t_{Boot_RF_1}$	RF boot time ⁽⁵⁾	TD_EVENT_UPDATE_EN=0b and UTC_EN=0b, from H _{FIELD_MIN}	-	-	1	ms
$t_{Boot_RF_2}$	RF boot time ⁽⁵⁾	TD_EVENT_UPDATE_EN=1b or UTC_EN=1b, from H _{FIELD_MIN}	-	-	5	ms
t_{RF_OFF}	RF power down duration needed to reset the IC	-	2	-	-	ms

Symbol	Description	Condition ⁽¹⁾⁽²⁾	Min	Typ	Max	Unit
t ₁	VICC response delay	-	318.6	320.9	323.3	μs
t ₂	VCD new request delay after a response from the VICC	-	309	311.5	314	μs
t ₃	VCD new request delay after no response from the VICC	-	323.3	-	-	μs
W _t	Duration of Write operation ⁽⁶⁾	Max 32 bits of data	-	4	-	ms
C _{TUN}	Input capacitance ⁽⁴⁾⁽⁷⁾	f = 13.56 MHz	21.85	23	24.15	pF
V _{BACK}	Minimum ISO15693 backscattering voltage	-	10	-	-	mV
V _{MIN_1} ⁽⁸⁾	Min input voltage amplitude (peak to peak) between AC0 and AC1	Inventory and Read operations	-	4.4	-	V
V _{MIN_2} ⁽⁸⁾	Min input voltage amplitude (peak to peak) between AC0 and AC1	Write operations	-	4.4	-	V
R _{closed}	Resistance of closed tamper loop	TD0 and TD1 connected	-	-	50	Ω
R _{open}	Resistance of open tamper loop	TD0 and TD1 not connected	1	-	-	MΩ
t _{RET}	Retention time	T _A ≤ 55 °C	60	-	-	year
Cycling	Write cycles endurance	T _A ≤ 85 °C	100000	-	-	cycle

1. T_A = -40 to 85 °C

2. All timing characterizations were performed on a reference antenna with the following characteristics:

- ISO antenna class1
- Tuning frequency = 13.7 MHz

3. Characterized on bench

4. Characterized at room temperature only, on wafer at POR level

5. Minimum time from carrier generation to start of first request

6. VCD request in 1 out of 4 coding, VICC response in high datarate and single subcarrier

7. For design of reference antenna. Min and Max value are deduced from correlation with industrial tester limits

8. (VAC0-VAC1) peak to peak characterized on bench

9 Package information

In order to meet environmental requirements, ST offers these devices in different grades of ECOPACK packages, depending on their level of environmental compliance. ECOPACK specifications, grade definitions and product status are available at: www.st.com. ECOPACK is an ST trademark.

9.1 Sawn and bumped wafer

Contact your STMicroelectronics sales office to get the description document.

9.2 UFDFPN5 (DFN5) package information

UFDFPN5 is a 5-lead, 1.7×1.4 mm, 0.55 mm thickness, ultra thin fine pitch dual flat package.

Figure 15. UFDFPN5 - Outline

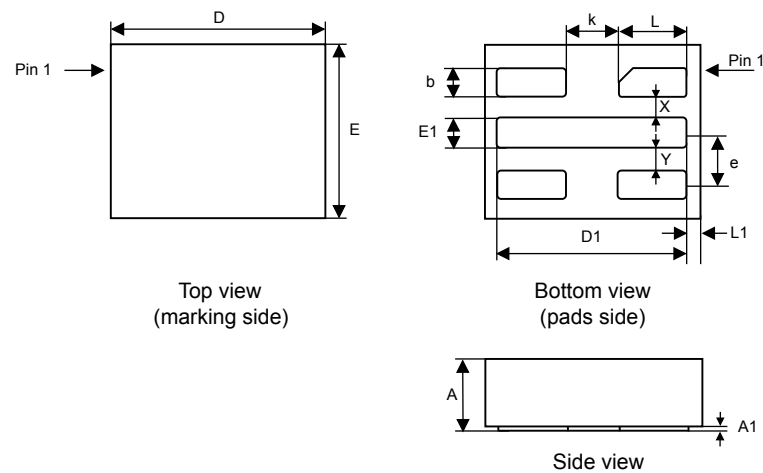

1. Maximum package warpage is 0.05 mm.
2. Exposed copper is not systematic and can appear partially or totally according to the cross section.
3. Drawing is not to scale.
4. On the bottom side, pin 1 is identified by the specific pad shape and, on the top side, pin 1 is defined from the orientation of the marking. When reading the marking, pin 1 is below the upper left package corner.

Table 173. UFDFPN5 - Mechanical data

Symbol	millimeters			inches ⁽¹⁾		
	Min	Typ	Max	Min	Typ	Max
A	0.500	0.550	0.600	0.0197	0.0217	0.0236
A1	0.000	-	0.050	0.0000	-	0.0020
b ⁽²⁾	0.175	0.200	0.225	0.0069	0.0079	0.0089
D	1.600	1.700	1.800	0.0630	0.0669	0.0709
D1	1.400	1.500	1.600	0.0551	0.0591	0.0630
E	1.300	1.400	1.500	0.0512	0.0551	0.0591
E1	0.175	0.200	0.225	0.0069	0.0079	0.0089
X	-	0.200	-	-	0.0079	-
Y	-	0.200	-	-	0.0079	-
e	-	0.400	-	-	0.0157	-
L	0.500	0.550	0.600	0.0197	0.0217	0.0236
L1	-	0.100	-	-	0.0039	-
k	-	0.400	-	-	0.0157	-

1. Values in inches are converted from mm and rounded to four decimal digits.
2. Dimension b applies to plated terminal and is measured between 0.15 and 0.30mm from the terminal tip.

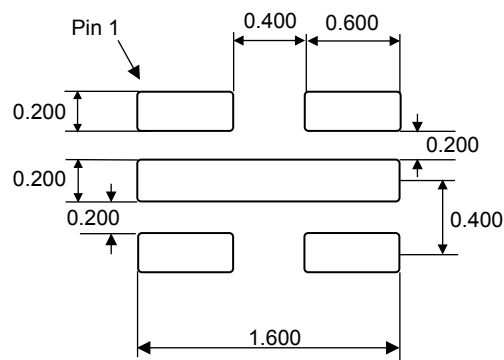
Figure 16. UFDFPN5 - Recommended footprint

Note: Dimensions are expressed in millimeters.

10 Ordering information

Table 174. Ordering information scheme

Example:	ST25TV	02K	C-	A	F	G	3
Device type							
ST25TV = NFC/RFID tag based on ISO 15693 and NFC T5T							
Memory size							
512 = 512 bits							
02K = 2560 bits							
Product version							
C = Version C							
Interface							
A = None							
T = Tamper detection							
Features							
F = Augmented NDEF							
Package							
F = 75 μm ± 10 μm bumped and sawn wafer							
G = 120 μm ± 10 μm bumped and sawn wafer							
H = UFDFPN5							
Capacitance							
3 = 23 pF							

Note: *Parts marked as “ES” or “E” are not yet qualified and therefore not approved for use in production. ST is not responsible for any consequences resulting from such use. In no event will ST be liable for the customer using any of these engineering samples in production. ST’s Quality department must be contacted prior to any decision to use these engineering samples to run a qualification activity.*

11 List of acronyms

Table 175. List of acronyms

Acronym	Definition
AFI	Application family identifier
ANDEF	Augmented NDEF
ASCII	American standard for information interchange
BSS	Block security status
CC	Capability container
CMD	Command
CRC	Cyclic redundancy check
DSFID	Data storage format identifier
EEPROM	Electrically-erasable programmable read-only memory
EOF	End of frame
FID	Feature identifier
GDPR	General data protection regulation
HZ	High impedance
IC	Integrated Circuit
Id	Identifier
NA	Not applicable
NC	Not connected
NDEF	NFC data exchange format
NFC	Near field communication
PID	Parameter identifier
POR	Power on reset
PWD	Password
RF	Radio frequency
RFID	RF identification
RFU	Reserved for future use
SOF	Start of frame
UFDFPN	Ultra thin Fine pitch Dual Flat Package No-lead
UTC	Unique tap code
TD	Tamper detection
UID	Unique identifier
VCD	Vicinity coupling device
VICC	Vicinity integrated circuit card
X	Any value in the range defined by the type ([0:1] for a bit, [0:F] for an hexadecimal nibble)

Revision history

Table 176. Document revision history

Date	Revision	Changes
15-Dec-2020	1	Initial release.
15-Jan-2021	2	Updated: <ul style="list-style-type: none"> • Section 5.2.2 Unique tap code description • Section 6.2.2 Request format • Section 6.2.4 Response format • Section 6.2.6 Response and error codes • Section 10 Ordering information

Contents

1	Description	2
1.1	Block diagram	2
1.2	Package connections	2
2	Functional overview	4
2.1	Block diagram	4
2.2	Application information	4
3	Power management	5
3.1	Device set	5
3.2	Device reset	5
4	Memory management	6
4.1	Memory organization	6
4.2	User memory	7
4.3	System configuration memory	8
4.3.1	System configuration registers	8
4.3.2	System registers	9
5	Specific features	10
5.1	Data protection	10
5.1.1	Data protection registers	10
5.1.2	Password management	15
5.1.3	Password encryption	18
5.1.4	User memory protection	19
5.1.5	System configuration memory protection	19
5.2	Unique tap code	20
5.2.1	Unique tap code registers	20
5.2.2	Unique tap code description	21
5.3	Tamper detection	21
5.3.1	Tamper detection registers	21
5.3.2	Tamper detection description	23
5.4	Augmented NDEF	24
5.4.1	Augmented NDEF registers	24

5.4.2	Augmented NDEF description	26
5.5	Consumer privacy protection	28
5.5.1	Example of Augmented NDEF messagePrivacy registers	29
5.5.2	Kill feature description	30
5.5.3	Untraceable feature description	30
5.6	TruST25™ digital signature	31
5.7	AFI protection	31
5.7.1	AFI protection registers	31
5.7.2	AFI protection description	31
5.8	Inventory Initiated	32
5.9	Device identification registers	32
6	RF Operation	35
6.1	RF communication	35
6.1.1	Access to a ISO/IEC 15693 device	35
6.2	RF protocol	35
6.2.1	Protocol description	35
6.2.2	Request format	36
6.2.3	Request flags	36
6.2.4	Response format	37
6.2.5	Response flags	38
6.2.6	Response and error codes	38
6.2.7	Modes	39
6.2.8	ISO15693 states	39
6.2.9	Custom states	41
6.3	Timing definition	42
6.4	RF commands	45
6.4.1	Inventory	46
6.4.2	StayQuiet	46
6.4.3	ReadSingleBlock	47
6.4.4	WriteSingleBlock	48
6.4.5	LockBlock	49
6.4.6	ReadMultipleBlocks	49

6.4.7	Select	50
6.4.8	ResetToReady	51
6.4.9	WriteAFI	52
6.4.10	LockAFI	52
6.4.11	WriteDSFID	53
6.4.12	LockDSFID	54
6.4.13	GetSystemInfo	54
6.4.14	GetMultipleBlockSecurityStatus	55
6.4.15	ExtendedGetSystemInfo	56
6.4.16	ReadConfiguration	58
6.4.17	WriteConfiguration	59
6.4.18	WritePassword	60
6.4.19	PresentPassword	61
6.4.20	Kill	62
6.4.21	Initiate	63
6.4.22	InventoryInitiated	64
6.4.23	ToggleUntraceable	65
6.4.24	GetRandomNumber	66
7	Unique identifier (UID)	68
7.1	Untraceable UID	68
8	Device parameters	69
8.1	Maximum ratings	69
8.2	RF electrical parameters	69
9	Package information	71
9.1	Sawn and bumped wafer	71
9.2	UFDFPN5 package information	71
10	Ordering information	73
11	List of acronyms	74
	Revision history	75
	Contents	76
	List of tables	80



List of figures.....84

List of tables

Table 1.	Signal names	3
Table 2.	User memory in single area mode	7
Table 3.	User memory in dual area mode	7
Table 4.	List of configuration registers	8
Table 5.	List of system registers	9
Table 6.	LCK_CONFIG access	10
Table 7.	LCK_CONFIG content	11
Table 8.	LCK_BLOCK access	11
Table 9.	LCK_BLOCK content	11
Table 10.	RW_PROTECTION_A1 access	12
Table 11.	RW_PROTECTION_A1 content	12
Table 12.	END_A1 access	12
Table 13.	END_A1 content	12
Table 14.	RW_PROTECTION_A2 access	13
Table 15.	RW_PROTECTION_A2 content	13
Table 16.	PWD_CFG access	13
Table 17.	PWD_CFG content	13
Table 18.	PWD_A1 access	14
Table 19.	PWD_A1 content	14
Table 20.	PWD_A2 access	14
Table 21.	PWD_A2 content	14
Table 22.	PWD_UNTR access	14
Table 23.	PWD_UNTR content	14
Table 24.	RND_NUMBER access	15
Table 25.	RND_NUMBER content	15
Table 26.	Security session type	15
Table 27.	List of password registers	15
Table 28.	RND_NUMBER_4B	18
Table 29.	RND_NUMBER_8B	18
Table 30.	Example of 64-bit Password_data value computation	18
Table 31.	Block security status	19
Table 32.	UTC_EN access	20
Table 33.	UTC_EN content	20
Table 34.	UTC access	21
Table 35.	UTC content	21
Table 36.	TD_EVENT_UPDATE_EN access	21
Table 37.	TD_EVENT_UPDATE_EN content	21
Table 38.	TD_SEAL_MSG access	22
Table 39.	TD_SEAL_MSG content	22
Table 40.	TD_UNSEAL_MSG access	22
Table 41.	TD_UNSEAL_MSG content	22
Table 42.	TD_RESEAL_MSG access	22
Table 43.	TD_RESEAL_MSG content	22
Table 44.	TD_SHORT_MSG access	22
Table 45.	TD_SHORT_MSG content	23
Table 46.	TD_OPEN_MSG access	23
Table 47.	TD_OPEN_MSG content	23
Table 48.	TD_STATUS access	23
Table 49.	TD_STATUS content	23
Table 50.	ANDEF_EN access	24
Table 51.	ANDEF_EN content	24
Table 52.	ANDEF_CFG access	25

Table 53.	ANDEF_CFG content	25
Table 54.	ANDEF_SEP access	25
Table 55.	ANDEF_SEP content	25
Table 56.	ANDEF_CUSTOM_LSB access	26
Table 57.	ANDEF_CUSTOM_LSB content	26
Table 58.	ANDEF_CUSTOM_MSB access	26
Table 59.	ANDEF_CUSTOM_MSB content	26
Table 60.	ANDEF_UID access	26
Table 61.	ANDEF_UID content	26
Table 62.	Block data read when ANDEF feature is disabled on ST25TV02KC	27
Table 63.	Block data read when ANDEF feature is enabled on ST25TV02KC	27
Table 64.	ANDEF fields concatenated in ANDEF_MEM	28
Table 65.	KILL_CMD access	29
Table 66.	KILL_CMD content	29
Table 67.	UNTR_CMD access	29
Table 68.	UNTR_CMD content	29
Table 69.	PRIVACY access	29
Table 70.	PRIVACY content	29
Table 71.	AFI_PROT access	31
Table 72.	AFI_PROT content	31
Table 73.	LCK_DSFD access	32
Table 74.	LCK_DSFD content	32
Table 75.	LCK_AFI access	32
Table 76.	LCK_AFI content	32
Table 77.	DSFID access	33
Table 78.	DSFID content	33
Table 79.	AFI access	33
Table 80.	AFI content	33
Table 81.	IC_REF access	33
Table 82.	IC_REF content	33
Table 83.	REV access	34
Table 84.	REV content	34
Table 85.	UID access	34
Table 86.	UID content	34
Table 87.	General request format	36
Table 88.	Definition of Request_flags LSBs	37
Table 89.	Definition of Request_flags MSBs when Inventory_flag value is 0	37
Table 90.	Definition of Request_flags MSBs when Inventory_flag value is 1	37
Table 91.	General response format	38
Table 92.	Definition of Response_flags	38
Table 93.	General response format when Error_flag equals 1	38
Table 94.	Definition of response error codes	38
Table 95.	Request_flags values depending on addressing mode	40
Table 96.	Device response depending on state and addressing mode	40
Table 97.	Timing values	43
Table 98.	Command code	45
Table 99.	Inventory request format	46
Table 100.	Inventory response format	46
Table 101.	StayQuiet request format	46
Table 102.	ReadSingleBlock request format	47
Table 103.	ReadSingleBlock response format when Error_flag equals 0	47
Table 104.	ReadSingleBlock error codes when Error_flag equals 1	48
Table 105.	WriteSingleBlock request format	48
Table 106.	WriteSingleBlock response format when Error_flag equals 0	48

Table 107.	WriteSingleBlock error codes when Error_flag equals 1	48
Table 108.	LockBlock request format	49
Table 109.	LockBlock response format when Error_flag equals 0	49
Table 110.	LockBlock error codes when Error_flag equals 1	49
Table 111.	ReadMultipleBlocks request format	50
Table 112.	ReadMultipleBlocks response format when Error_flag equals 0	50
Table 113.	ReadMultipleBlocks error codes when Error_flag equals 1	50
Table 114.	Select request format	50
Table 115.	Select response format when Error_flag equals 0	51
Table 116.	Select error codes when Error_flag equals 1	51
Table 117.	ResetToReady request format	51
Table 118.	ResetToReady response format when Error_flag equals 0	51
Table 119.	ResetToReady error codes when Error_flag equals 1	51
Table 120.	WriteAFI request format	52
Table 121.	WriteAFI response format when Error_flag equals 0	52
Table 122.	WriteAFI error codes when Error_flag equals 1	52
Table 123.	LockAFI request format	52
Table 124.	LockAFI response format when Error_flag equals 0	53
Table 125.	LockAFI error codes when Error_flag equals 1	53
Table 126.	WriteDSFID request format	53
Table 127.	WriteDSFID response format when Error_flag equals 0	53
Table 128.	WriteDSFID error codes when Error_flag equals 1	54
Table 129.	LockDSFID request format	54
Table 130.	LockDSFID response format when Error_flag equals 0	54
Table 131.	LockDSFID error codes when Error_flag equals 1	54
Table 132.	GetSystemInfo request format	55
Table 133.	GetSystemInfo response	55
Table 134.	GetSystemInfo error codes when Error_flag equals 1	55
Table 135.	GetMultipleBlockSecurityStatus request format	55
Table 136.	GetMultipleBlockSecurityStatus response format when Error_flag equals 0	56
Table 137.	GetMultipleBlockSecurityStatus error codes when Error_flag equals 1	56
Table 138.	ExtendedGetSystemInfo request format	56
Table 139.	Information_request_list content	56
Table 140.	ExtendedGetSystemInfo response format when Error_flag equals 0	57
Table 141.	Information_flags content	57
Table 142.	Information_fields content	57
Table 143.	ExtendedGetSystemInfo error codes when Error_flag equals 1	58
Table 144.	ReadConfiguration request format	58
Table 145.	ReadConfiguration response format when Error_flag equals 0	58
Table 146.	ReadConfiguration error codes when Error_flag equals 1	58
Table 147.	WriteConfiguration request format	59
Table 148.	WriteConfiguration response format when Error_flag equals 0	59
Table 149.	WriteConfiguration error codes when Error_flag equals 1	60
Table 150.	WritePassword request format	60
Table 151.	WritePassword response format when Error_flag equals 0	61
Table 152.	WritePassword error codes when Error_flag equals 1	61
Table 153.	PresentPassword request format	61
Table 154.	PresentPassword response format when Error_flag equals 0	62
Table 155.	PresentPassword error codes when Error_flag equals 1	62
Table 156.	Kill request format	62
Table 157.	Kill response format when Error_flag equals 0	63
Table 158.	Kill error codes when Error_flag equals 1	63
Table 159.	Initiate request format	63
Table 160.	Initiate response format when Error_flag equals 0	64

Table 161.	InventoryInitiated request format	64
Table 162.	InventoryInitiated response format when Error_flag equals 0	64
Table 163.	ToggleUntraceable request format	65
Table 164.	ToggleUntraceable response format when Error_flag equals 0	65
Table 165.	ToggleUntraceable error codes when Error_flag equals 1	66
Table 166.	GetRandomNumber request format	66
Table 167.	GetRandomNumber response format when Error_flag equals 0	66
Table 168.	GetRandomNumber error codes when Error_flag equals 1	66
Table 169.	UID format	68
Table 170.	Untraceable UID : UID value in UNTRACEABLE state	68
Table 171.	Absolute maximum ratings	69
Table 172.	RF characteristics	69
Table 173.	UFDFPN5 - Mechanical data	72
Table 174.	Ordering information scheme.	73
Table 175.	List of acronyms	74
Table 176.	Document revision history	75

List of figures

Figure 1.	ST25TVxxxC block diagram	2
Figure 2.	UFDFPN5 package connections	3
Figure 3.	Die connections for sawn and bumped wafer	3
Figure 4.	RF power-up sequence	5
Figure 5.	Memory organization	6
Figure 6.	Security sessions management	17
Figure 7.	Example of augmented NDEF message on ST25TV02KC-T	28
Figure 8.	ISO15693 protocol timing	36
Figure 9.	ISO15693 state transition diagram	40
Figure 10.	ST25TVxxxC state transition diagram	41
Figure 11.	Read-alike frame exchange between VCD and ST25TVxxxC	42
Figure 12.	Write-alike frame exchange between VCD and ST25TVxxxC when Option_flag=0	43
Figure 13.	Write-alike frame exchange between VCD and ST25TVxxxC when Option_flag=1	44
Figure 14.	Stay Quiet frame	47
Figure 15.	UFDFPN5 - Outline	71
Figure 16.	UFDFPN5 - Recommended footprint	72

IMPORTANT NOTICE – PLEASE READ CAREFULLY

STMicroelectronics NV and its subsidiaries (“ST”) reserve the right to make changes, corrections, enhancements, modifications, and improvements to ST products and/or to this document at any time without notice. Purchasers should obtain the latest relevant information on ST products before placing orders. ST products are sold pursuant to ST’s terms and conditions of sale in place at the time of order acknowledgement.

Purchasers are solely responsible for the choice, selection, and use of ST products and ST assumes no liability for application assistance or the design of Purchasers’ products.

No license, express or implied, to any intellectual property right is granted by ST herein.

Resale of ST products with provisions different from the information set forth herein shall void any warranty granted by ST for such product.

ST and the ST logo are trademarks of ST. For additional information about ST trademarks, please refer to www.st.com/trademarks. All other product or service names are the property of their respective owners.

Information in this document supersedes and replaces information previously supplied in any prior versions of this document.

© 2021 STMicroelectronics – All rights reserved