

XC9143/XC9144 Series

ETR04027-001

18V 1.0A Synchronous Step-Up DC/DC Converters

☆Green Operation-compatible

■GENERAL DESCRIPTION

The XC9143/44 series is a synchronous step-up DC/DC converter that incorporates two driver transistors required for switching operation. The input voltage range can correspond to a wide range from a minimum of 1.3 V to a maximum of 16V.

Built-in low on-resistance driver transistor enable to supply with output current up to 400mA ($V_{OUT}=12V$, $V_{IN}=5.0V$). Regarding XC9144, since PFM operation is performed automatically in low output current region, it can support the output power with high efficiency from light load to heavy load.

Since compensation components required for stable operation are built in, it is unnecessary to select external components or perform constant design for phase compensation. Additionally, since each protection function, limit value, etc. are adjusted internally, it is possible to reduce the number of external parts required for operation. Because the on-board package is compact as USP-6C, it contributes to reducing the occupied area together with a small number of parts.

■APPLICATIONS

- Portable equipment
- Beauty & health equipment
- Wearable devices
- Game & Hobby
- PC Peripherals
- Devices with 2~10 Alkaline battery,
Nickel Hydride battery,
1~3 Lithium and Li-ion battery

■FEATURES

Input Voltage Range	: 1.3V ~ 16.0V
Operation Start Voltage	: 1.7V (TYP.)
Output Voltage Range	: 7.0V ~ 18.0V
FB Voltage	: 1.0V ($\pm 1.5\%$)
Oscillation Frequency	: 1.2MHz, 3.0MHz ($\pm 15\%$)
Efficiency	: 90% @ $V_{OUT}=7V$, $V_{IN}=3.3V$, $I_{OUT}=200mA$ 91% @ $V_{OUT}=12V$, $V_{IN}=5.0V$, $I_{OUT}=200mA$ 88% @ $V_{OUT}=12V$, $V_{IN}=3.3V$, $I_{OUT}=100mA$
Output Current	: 400mA @ $V_{OUT}=7V$, $V_{IN}=3.3V$ @ $T_a=25^\circ C$ 400mA @ $V_{OUT}=12V$, $V_{IN}=5.0V$ @ $T_a=25^\circ C$ 200mA @ $V_{OUT}=12V$, $V_{IN}=3.3V$ @ $T_a=25^\circ C$
Control Mode	: PWM (XC9143 Series) Auto PWM/PFM (XC9144 Series)
Protection Circuits	: Input Current Limit Thermal Shutdown
Functions	: Inrush Current Prevention
Capacitor	: Ceramic Capacitor
Operating Ambient Temperature	: $-40^\circ C$ ~ $105^\circ C$
Package	: USP-6C (1.8 x 2.0 x 0.6mm)
Environmentally Friendly	: EU RoHS Compliant, Pb Free

■TYPICAL APPLICATION CIRCUIT

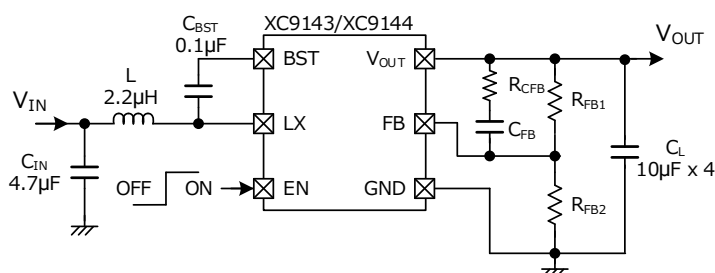

■TYPICAL PERFORMANCE CHARACTERISTICS

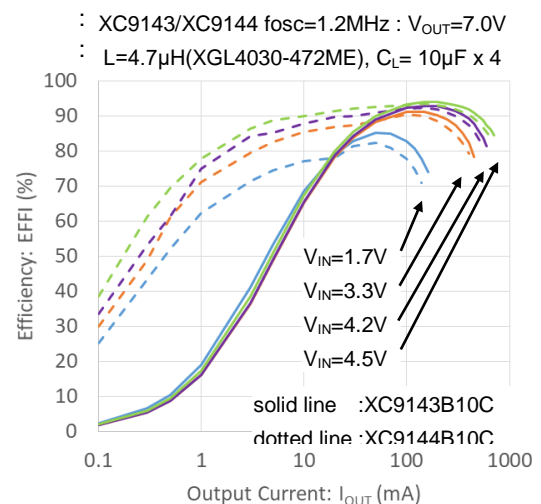

■ BLOCK DIAGRAM

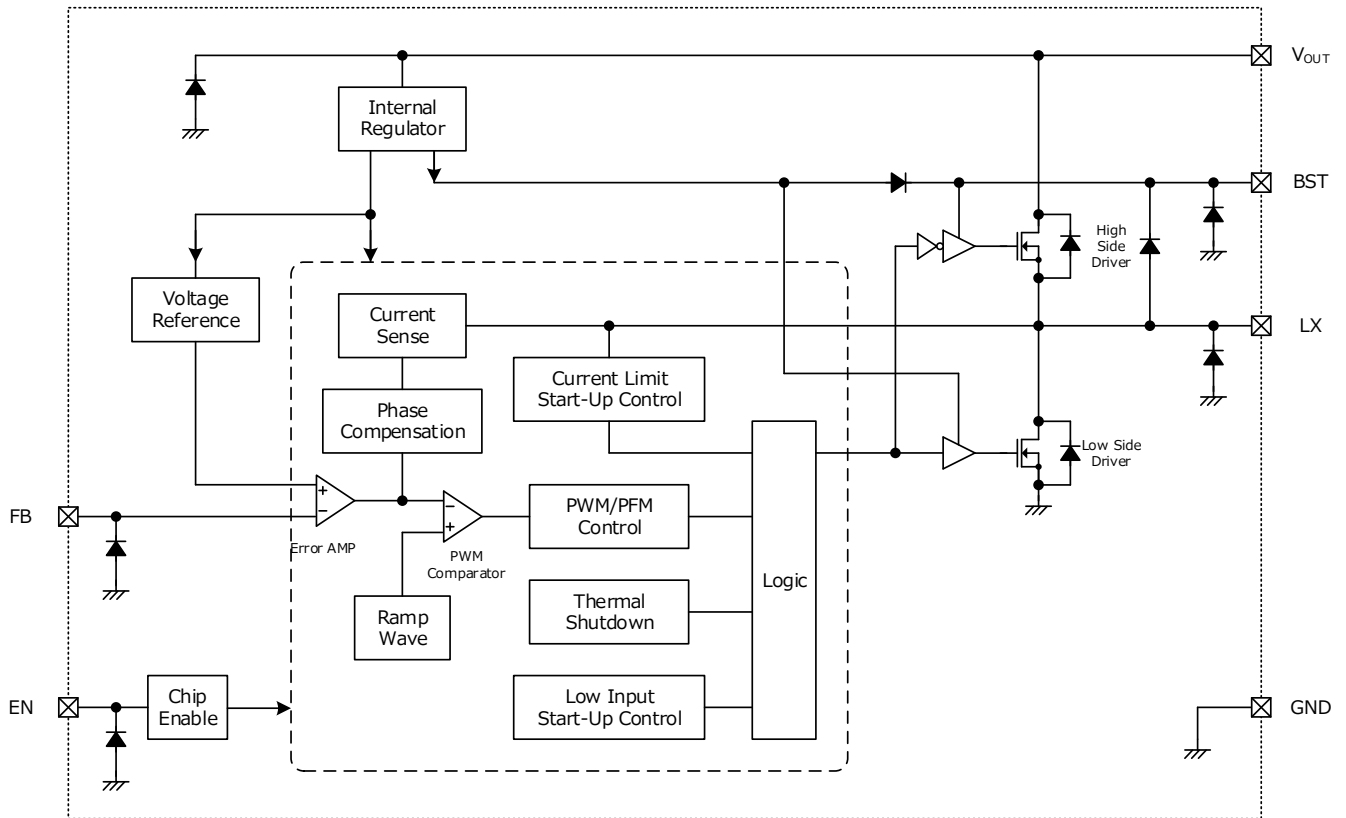

* Diodes inside the circuits are ESD protection diodes and parasitic diodes.

* XC9143 series support only PWM control.

■ PRODUCT CLASSIFICATION

● Ordering Information

XC9143B①②③④⑤-⑥ : PWM control

XC9144B①②③④⑤-⑥ : PWM/PFM automatic switching control

DESIGNATOR	ITEM	SYMBOL	DESCRIPTION
①②	Output Voltage	10	Output voltage can be adjusted in 7.0V to 18V
③	Oscillation Frequency	C	1.2MHz
		D	3.0MHz
④⑤-⑥ ^(*)	Packages (Order Unit)	ER-G	USP-6C (3,000pcs/Reel)

^(*) The "-G" suffix indicates that the products are Halogen and Antimony free as well as being fully EU RoHS compliant.

■ PIN CONFIGURATION

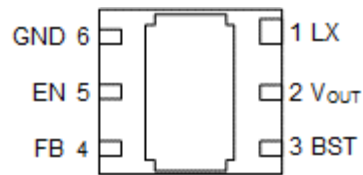

USP-6C
(BOTTOM VIEW)

*The dissipation pad for the USP-6C package should be solder-plated in recommended mount pattern and metal masking so as to enhance mounting strength and heat release. If the pad needs to be connected to other pins, it should be connected to the GND pin.

■ PIN ASSIGNMENT

PIN NUMBER	PIN NAME	FUNCTIONS
1	LX	Switching Output
2	V _{OUT}	Power Output
3	BST	Boost for Switching
4	FB	Output Voltage Feedback
5	EN	Enable
6	GND	Ground

■ FUNCTION CHART

PIN NAME	SIGNAL	STATUS
EN	L	Stand-by
	H	Active
	OPEN	Undefined State ^(*)

* Do not leave the CE pin open.

■ ABSOLUTE MAXIMUM RATINGS

PARAMETER		SYMBOL	RATINGS	UNITS
BST Pin Voltage		V_{BST}	$V_{Lx} - 0.3 \sim V_{Lx} + 6.2$	V
Lx Pin Voltage		V_{Lx}	$-0.3 \sim V_{OUT} + 0.3$ or 20 ^(*)	V
V_{OUT} Pin Voltage		V_{OUT}	$-0.3 \sim 20$	V
FB Pin Voltage		V_{FB}	$-0.3 \sim 6.2$	V
EN Pin Voltage		V_{EN}	$-0.3 \sim 20$	V
Power Dissipation ($T_a=25^\circ\text{C}$)	USP-6C	P_d	1250 (JESD51-7 board) ^(*)	mW
Junction Temperature		T_j	$-40 \sim 125$	$^\circ\text{C}$
Storage Temperature		T_{stg}	$-55 \sim 125$	$^\circ\text{C}$

GND are standard voltage for all of the voltage.

^(*) The maximum value should be either $V_{OUT}+0.3\text{V}$ or 20V in the lowest.

^(*) The power dissipation figure shown above is based upon PCB mounted and it is for reference only.

Please refer to PACKAGING INFORMATION for the mounting condition.

■ RECOMMENDED OPERATING CONDITIONS

PARAMETER		SYMBOL	MIN.	TYP.	MAX.	UNITS
Output Voltage Setting Range ^(*)		V_{OUTSET}	7.0	-	18.0	V
Input Voltage ^(*)		V_{IN}	1.3	-	16.0	V
Lx Pin Current ^(*)		I_{Lx}	-5.0	-	5.0	A
EN Pin Voltage		V_{EN}	0.0	-	16.0	V
Operating Ambient Temperature		T_{opr}	-40	-	105	$^\circ\text{C}$
Input Capacitor (Effective Value) ^(*)		C_{IN}	-	4.7	-	μF
Output Capacitor (Effective Value)	$V_{OUTSET} \leq 9.0\text{V}$	C_L	-	9.0	-	μF
	$V_{OUTSET} > 9.0\text{V}$		-	7.0	-	
Inductor	$f_{OSC} = 1.2\text{MHz}$,	L	-	4.7	-	μH
	$f_{OSC} = 3.0\text{MHz}$		-	2.2	-	

GND are standard voltage for all the voltage.

^(*) Please refer to NOTE ON USE for the recommended operating range for each product.

^(*) Due to the Lx pin current, the junction temperature may cross over the maximum junction temperature.

Please use within the range that does not cross over the maximum junction temperature.

ELECTRICAL CHARACTERISTICS

Ta=25°C

PARAMETER	SYMBOL	CONDITIONS	MIN.	TYP.	MAX.	UNITS	CIRCUIT	
Input Voltage ^(*)	V _{IN}	XC9143B10C	1.3	-	15.3	V	①	
		XC9144B10C	1.3	-	16.0			
		XC9143B10D, XC9144B10D	1.3	-	11.7			
Operation Start Voltage	V _{ST}	I _{OUT} =0mA, V _{EN} >V _{ENH} , R _{FB2} =10kΩ	-	1.7	2.3	V	①	
Operation Hold Voltage ^(*)	V _{HLD}	V _{OUT} > V _{OUTSET} ×90%, (V _{OUT} -V _{HLD})/V _{OUT} <D _{MAX} , I _{OUT} =0mA, V _{EN} >V _{ENH}	-	1.3	-	V	①	
Quiescent Current	I _{QPFM}	V _{FB} =1.1V, V _{OUT} =12V, V _{LX} =V _{OUT} (XC9144)	f _{OSC} = 1.2MHz	-	55	65	μA	②
			f _{OSC} = 3.0MHz	-	85	110	μA	
	I _{QPWM}	V _{FB} =1.1V, V _{OUT} =12V, V _{LX} =V _{OUT} (XC9143)	f _{OSC} = 1.2MHz	-	0.25	0.34	mA	
			f _{OSC} = 3.0MHz	-	0.45	0.57	mA	
Stand-by Current	I _{STB}	V _{EN} =0V, V _{OUT} =12V	-	5.0	10	μA	②	
FB Voltage	V _{FB}	V _{OUT} =8V	0.985	1.000	1.015	V	③	
Oscillation Frequency	f _{OSC}	V _{OUT} =8V	f _{OSC} = 1.2MHz	1.02	1.20	1.38	MHz	③
			f _{OSC} = 3.0MHz	2.55	3.00	3.45	MHz	
Minimum Duty Cycle	D _{MIN}	V _{FB} =1.1V, V _{OUT} =8V	-	-	0	%	③	
Maximum Duty Cycle	D _{MAX}	V _{FB} =0.9V, V _{OUT} =8V	f _{OSC} = 1.2MHz	89	95	-	%	③
			f _{OSC} = 3.0MHz	86	92	-	%	
LX SW "H" On Resistance	R _{LXH}	I _{LX} =100mA, V _{OUT} =8V	-	0.40	0.74	Ω	-	
LX SW "L" On Resistance	R _{LXL}	I _{LX} =100mA, V _{OUT} =8V	-	0.25	0.40	Ω	-	
LX "H" Leakage Current	I _{LXLH}	V _{EN} =0V, V _{OUT} =12V, V _{LX} =12V	-	0.0	1.4	μA	②	
LX "L" Leakage Current	I _{LXLL}	V _{EN} =0V, V _{OUT} =12V, V _{LX} =0V	-	0.0	1.6	μA	②	
PFM Switching Current (XC9144)	I _{PFM}	f _{OSC} = 1.2MHz V _{IN} =5.0V, V _{OUTSET} =12V, L=4.7μH	260	300	400	mA	①	
		f _{OSC} = 3.0MHz V _{IN} =5.0V, V _{OUTSET} =12V, L=2.2μH	400	500	700	mA		
Current Limit	I _{LIM}	f _{OSC} = 1.2MHz V _{IN} =5.0V, V _{OUTSET} =12V, L=4.7μH	1600	2000	3000	mA	①	
		f _{OSC} = 3.0MHz V _{IN} =5.0V, V _{OUTSET} =12V, L=2.2μH						
Thermal Shutdown Detect	T _{TSD}	V _{OUT} =8V	-	150	-	°C	①	
Thermal Shutdown Hysteresis	T _{HYS}	V _{OUT} =8V	-	25	-	°C	①	
EN "H" Voltage	V _{ENH}	V _{OUT} =8V	Ta=25°C	1.6	-	16.0	V	③
			Ta=-40~105°C ^(*)					
EN "L" Voltage	V _{ENL}	V _{OUT} =8V	Ta=25°C	GND	-	0.3	V	③
			Ta=-40~105°C ^(*)					
EN "H" Current	I _{ENH}	V _{OUT} =12V, V _{EN} =16V	-	3.0	4.0	μA	②	
EN "L" Current	I _{ENL}	V _{OUT} =12V, V _{EN} =0V	-	0.0	0.3	μA	②	
FB "H" Current	I _{FBH}	V _{OUT} =12V, V _{FB} =2V	-	0.0	0.3	μA	②	
FB "L" Current	I _{FBL}	V _{OUT} =12V, V _{FB} =0V	-	0.0	0.3	μA	②	

(*) Design value

TYPICAL APPLICATION CIRCUIT

<Test Circuit ①>

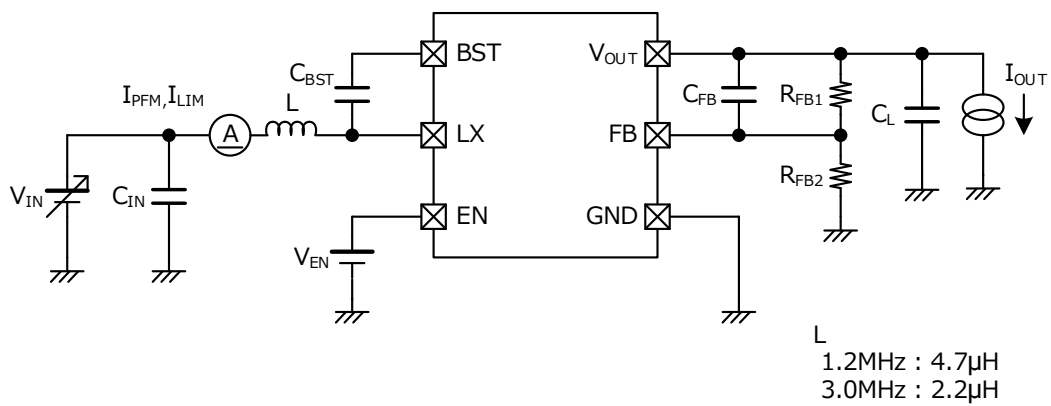

<Test Circuit ②>

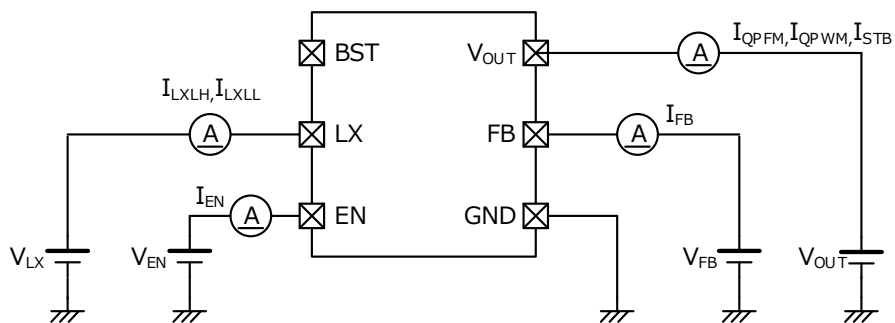

<Test Circuit ③>

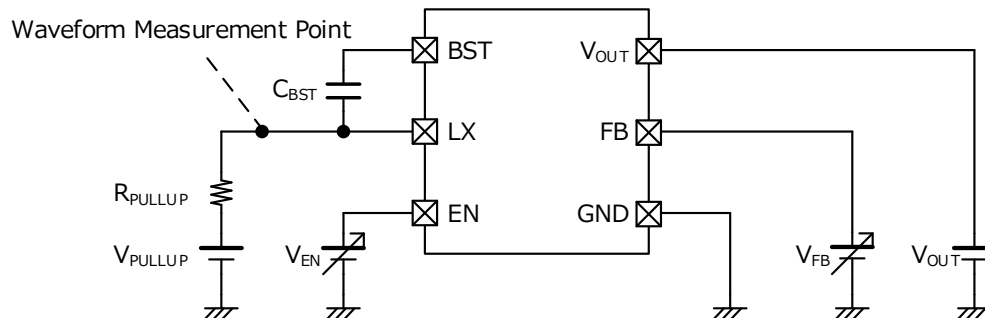

TYPICAL APPLICATION CIRCUIT / PARTS SELECTION GUIDE

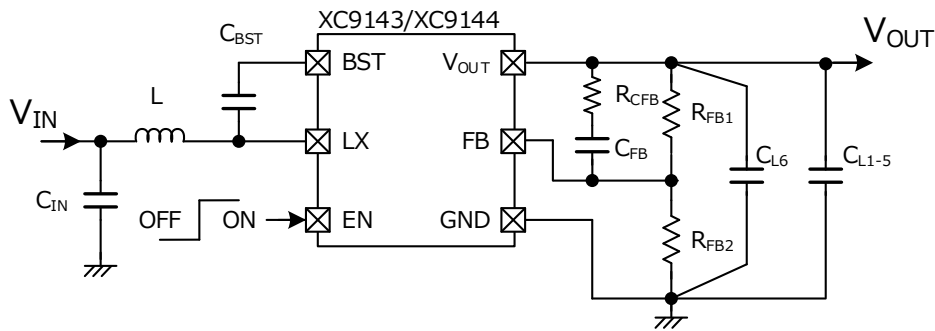

【Typical Examples】 $f_{osc} = 1.2\text{MHz}$

	MANUFACTURER	PRODUCT NUMBER	VALUE	SIZE(LxWxT)
L	Murata	DFE322512F-4R7M=P2	4.7 μH	3.2 x 2.5 x 1.2mm
	Coilcraft	XGL4030-472ME	4.7 μH	4.0 x 4.0 x 3.1mm
	Sunlord	SWPA4030S4R7MT	4.7 μH	4.0 x 4.0 x 3.0mm
	TDK	CLF5030NIT-4R7N-D	4.7 μH	4.4 x 4.1 x 2.0mm

【Typical Examples】 $f_{osc} = 3.0\text{MHz}$

	MANUFACTURER	PRODUCT NUMBER	VALUE	SIZE(LxWxT)
L	Murata	DFE252012F-2R2M=P2	2.2 μH	2.5 x 2.0 x 1.2mm
	Coilcraft	XGL3520-222ME	2.2 μH	3.5 x 3.2 x 2.0mm
	Tokyo Coil	SHP0420P-F2R2NAP	2.2 μH	4.0 x 4.0 x 2.0mm
	Sunlord	SWPA4030S2R2NT	2.2 μH	4.0 x 4.0 x 3.0mm
	TDK	SPM4020T-2R2M-LR	2.2 μH	5.3 x 5.0 x 3.0mm

【Typical Examples】 $f_{osc} = 1.2\text{MHz}$, $f_{osc} = 3.0\text{MHz}$

	Conditions	MANUFACTURER	PRODUCT NUMBER	VALUE	SIZE(LxWxT)
$C_{IN}^{(*)}$	-	Murata	GRM188R61E475KE11	4.7 $\mu\text{F}/25\text{V}$	1.6 x 0.8 x 0.8mm
$C_{L1-5}^{(**)}$	$7\text{V} \leq V_{OUTSET} \leq 9\text{V}$	Murata	GRM21BR61E226ME44	22 $\mu\text{F}/25\text{V}$ x 2	2.0 x 1.25 x 1.25mm
	$9\text{V} < V_{OUTSET} \leq 11\text{V}$	Murata	GRM21BR61E226ME44	22 $\mu\text{F}/25\text{V}$ x 2	
		Murata	GRM21BR61E106KA73	10 $\mu\text{F}/25\text{V}$ x 3	
	$11\text{V} < V_{OUTSET} \leq 14\text{V}$	Murata	GRM21BR61E226ME44	22 $\mu\text{F}/25\text{V}$ x 2	
		Murata	GRM21BR61E106KA73	10 $\mu\text{F}/25\text{V}$ x 4	
		Murata	GRM21BR61E226ME44	22 $\mu\text{F}/25\text{V}$ x 3	
$14\text{V} < V_{OUTSET} \leq 18\text{V}$	Murata	GRM21BR61E106KA73	10 $\mu\text{F}/25\text{V}$ x 5		
$C_{BST}^{(***)}$	-	-	-	0.1 $\mu\text{F}/10\text{V}$ or more	-

(*1) For C_{IN} , use a low ESR capacitor that ensures a capacitance equivalent to or greater than the recommended component.

(*2) For C_L , use a low ESR capacitor that ensures a capacitance equivalent to or greater than the recommended component.

Please also note that the IC's output voltage may become unstable with using such capacitors due to low effective capacitance value.

If using electrolytic capacitor in parallel for the CL, the inrush current may increase at startup and the output voltage may become unstable.

(*3) For C_{BST} , use a low ESR capacitor that ensures a capacitance of about 0.1 μF at 5V.

If using capacitors with significantly different effective capacitance, efficiency may decrease and operation may become unstable at startup.

■ TYPICAL APPLICATION CIRCUIT / PARTS SELECTION GUIDE

<Output voltage setting Value V_{OUTSET} Setting >

The output voltage can be set by adding an external dividing resistor.

The output voltage is determined by the equation below based on the values of R_{FB1} and R_{FB2} .

$$V_{OUTSET} = V_{FB} \times (R_{FB1} + R_{FB2}) / R_{FB2}$$

However, $R_{FB2} \leq 150k\Omega$ and $R_{FB1} \leq 1M\Omega$

Regarding to the available input / output voltage range, please refer to NOTES ON USE.

< C_{FB} setting >

Set the value of the phase compensation capacitor C_{FB} as the following $f_{zfb} = 1 / (2 \times \pi \times C_{FB} \times R_{FB1})$.

$$f_{OSC} = 1.2MHz : f_{zfb} = 1.0kHz \sim 4.0kHz$$

However, $68pF \leq C_{FB}$

$$f_{OSC} = 3.0MHz : f_{zfb} = 2.0kHz \sim 6.0kHz$$

However, $47pF \leq C_{FB}$

If an output capacitance value out of the recommended range is used, stable operation may not be possible within the above f_{zfb} setting range. In that case, set the value referring to the following formula.

$$f_{zfb} = 1 / (2 \times \pi \times (L \times C_L)^{1/2} \times 10)$$

< R_{CFB} , C_{L6} setting >

Depending on the PCB layout, switching noise can reduce load stability.

By inserting a resistor R_{CFB} in series with the C_{FB} , it is possible to take measures against a decrease in load stability.

Set the resistance value of R_{CFB} as the following.

$$100MHz < 1 / (2 \times \pi \times C_{FB} \times R_{CFB})$$

If the decrease in load stability does not improve with adding the R_{CFB} , place a ceramic capacitor C_{L6} of about $0.1\mu F$ to $1\mu F$ near the R_{FB1} .

【Setting Example of XC9143】

V_{OUTSET}	R_{FB1}	R_{FB2}	R_{CFB}	$f_{OSC} = 1.2MHz$		$f_{OSC} = 3.0MHz$	
				C_{FB}	f_{zfb}	C_{FB}	f_{zfb}
7.0V	60k Ω (68k Ω //510k Ω)	10k Ω	100 Ω	680pF	3.9kHz	470pF	5.6kHz
12.0V	110k Ω	10k Ω	100 Ω	680pF	2.1kHz	470pF	2.8kHz
15.0V	140k Ω (200k Ω //470k Ω)	10k Ω	100 Ω	680pF	1.6kHz	470pF	2.3kHz
18.0V	170k Ω (220k Ω //750k Ω)	10k Ω	100 Ω	680pF	1.4kHz	470pF	2.0kHz

【Setting Example of XC9144】

V_{OUTSET}	R_{FB1}	R_{FB2}	R_{CFB}	$f_{OSC} = 1.2MHz$		$f_{OSC} = 3.0MHz$	
				C_{FB}	f_{zfb}	C_{FB}	f_{zfb}
7.0V	900k Ω (1.2M Ω //3.6M Ω)	150k Ω	100 Ω	91pF	1.9kHz	62pF	2.9kHz
12.0V	825k Ω (1.0M Ω //4.7M Ω)	75k Ω	100 Ω	100pF	1.9kHz	68pF	2.8kHz
15.0V	955k Ω (1.3M Ω //3.6M Ω)	68k Ω	100 Ω	82pF	2.0kHz	56pF	3.0kHz
18.0V	955k Ω (1.3M Ω //3.6M Ω)	56k Ω	100 Ω	82pF	2.0kHz	56pF	3.0kHz

TYPICAL APPLICATION CIRCUIT/PARTS SELECTION GUIDE

<Load disconnection function>

This IC does not have a load disconnection function. Therefore, in the standard circuit, the input voltage is output to the output voltage via the parasitic diode even in the standby mode, and the standby current of the IC is consumed.

To take these measures, it is necessary to cut off the input side and output side with FETs.

(1) Input line cutoff (Standby mode: output voltage cutoff, input current cutoff)

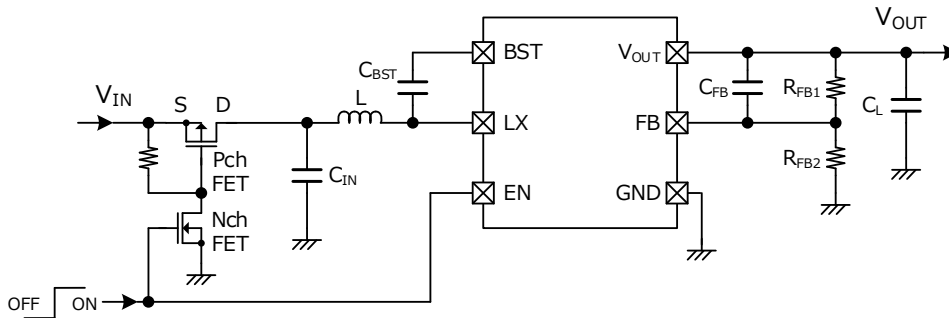

(2-1) Output line cutoff 1 (Standby mode: output voltage cutoff)

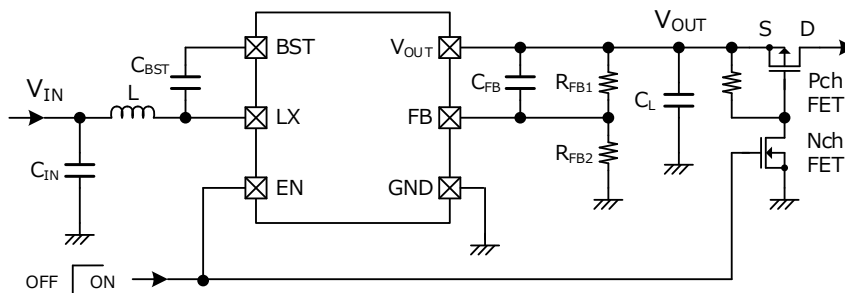

(2-2) Output line cutoff 2 (Standby mode: output voltage cutoff)

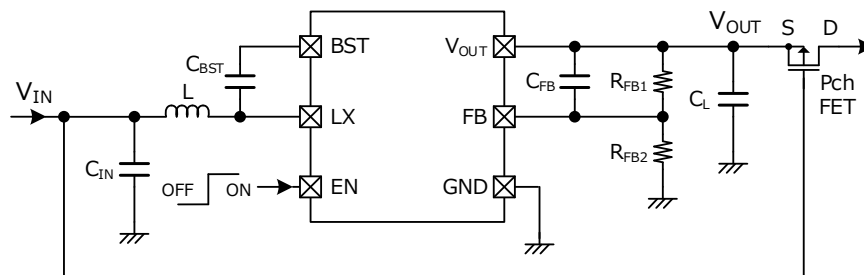

<LED driver circuit>

The LED drive circuit can be configured by inserting an LED between the VOUT pin and FB pin of this IC.

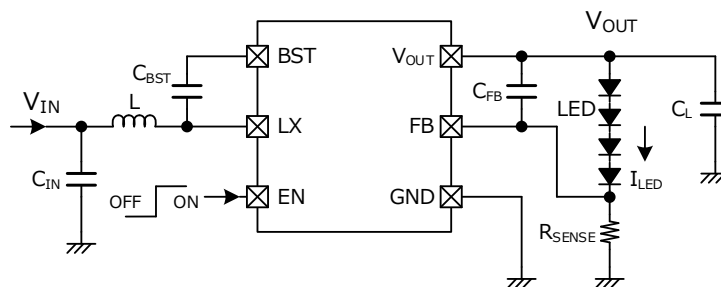

$$I_{LED} = V_{FB} \div R_{SENSE}$$

OPERATIONAL EXPLANATION

The XC9143/XC9144 series consists of an internal regulator, reference voltage source, DC / DC control, prebuffer, High side driver FET, Low side driver FET, etc.

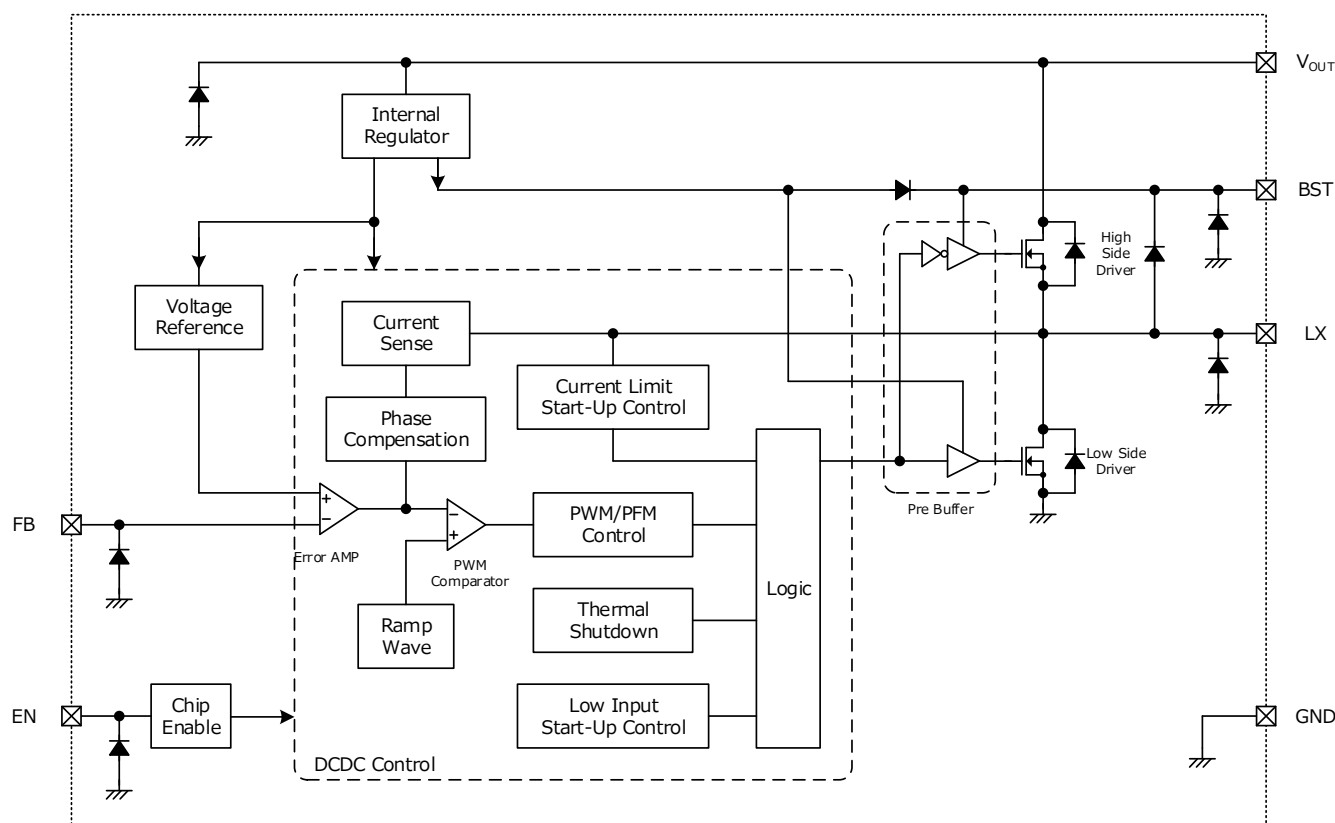

The main function of this IC is a current mode control step-up DC / DC converter that supports low ESR ceramic capacitors. By adopting current mode control and increasing the oscillation frequency to a high frequency, the size of peripheral parts has been reduced.

In addition, because it is a synchronous with two built-in driver FETs required for switching operation, it is possible to achieve higher efficiency / miniaturization than the asynchronous with an external diode.

<Driver configuration>

The built-in driver FET is Nch FET for both High Side and Low Side, and there is a parasitic diode whose source is the anode and the drain is the cathode. In the High Side driver, the diode goes from LX to V_{OUT} in the forward direction, so if $LX (= V_{IN}) > V_{OUT}$ in the standby mode, current will flow from V_{IN} to V_{OUT} via the parasitic diode.

<Internal regulator / bootstrap circuit (BST terminal)>

This IC has a built-in regulator that inputs the V_{OUT} pin for supplying voltage to the internal circuit. This regulator outputs voltage even in the standby mode.

In addition to the internal circuit, the regulator supplies voltage to the BST pin via a backflow prevention diode. In the active mode, a voltage of about 5V is output between BST pin and LX pin ($V_{BST} = V_{LX} + 5V$). In the standby mode, the lower of 5V or the input voltage is output to the BST pin.

To prevent malfunction, there is a low voltage protection function for the internal regulator output. When the V_{OUT} drops below 5V, the internal regulator output drops and the low voltage protection function operates to enter the low voltage detection state.

In the low voltage detection state, the low input start-up circuit starts operating and automatically recovers the V_{OUT} to the set value. For the low input startup circuit, please refer to the "Startup operation" section.

In addition, the current limit and thermal shutdown functions do not operate in the low voltage detection state.

OPERATIONAL EXPLANATION

<Normal operation>

The error amplifier compares the internal reference voltage with FB voltage. In order to input a signal to the PWM comparator, the phase compensation is performed on the resulting error amplifier output. The PWM comparator compares, the signal from the error amplifier with the ramp wave from the ramp wave circuit, and delivers the resulting output to the buffer driver circuit to control the duty during PWM control. The output voltage is stabilized by performing these controls continuously.

The current feedback circuit monitors the N-channel driver transistor's turn-on current for each switching operation, and modulates the error amplifier output signal to provide multiple feedback signals. This enables a stable feedback loop even when a low ESR capacitor, such as a ceramic capacitor, is used, ensuring stable output voltage.

The current sense circuit monitors the low side driver transistor's turn-on current for each switching operation, and modulates the error amplifier output signal to provide multiple feedback signals (current feedback circuit). This enables a stable feedback loop even when a low ESR capacitor, such as a ceramic capacitor is used, ensuring stable output voltage.

Regarding to the parts required for operation, select the constants by referring to the part selection section. If a component that is significantly different from this constant is used, proper phase compensation may not be obtained and DC / DC may operate unstable. Also, when using a capacitance other than a ceramic capacitor, use a low ESR capacitance. If a capacitor with a high ESR is used, heat generation of the capacitor and unstable DC / DC operation may occur.

XC9143 Series

The XC9143 Series (PWM control) performs switching at a set switching frequency f_{osc} regardless of the output current. When the V_{OUT} voltage becomes higher than V_{OUTSET} , the switching operation is stopped (High side / Low side driver is turned off), and the switching operation is stopped until the V_{OUT} voltage drops.

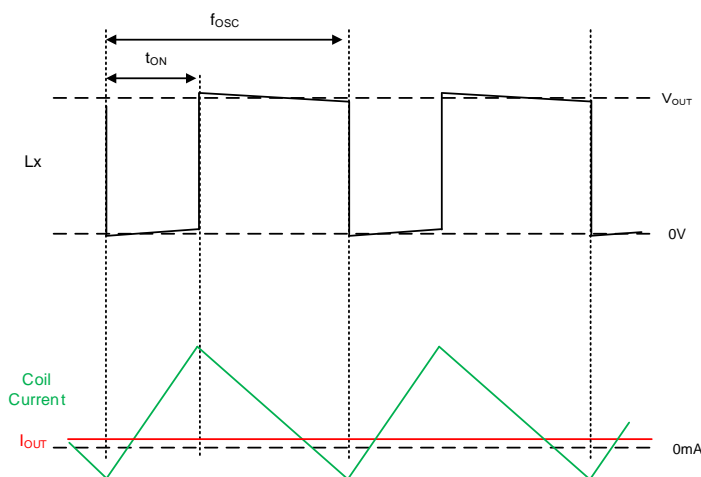

XC9143 Series : Example of light load operation

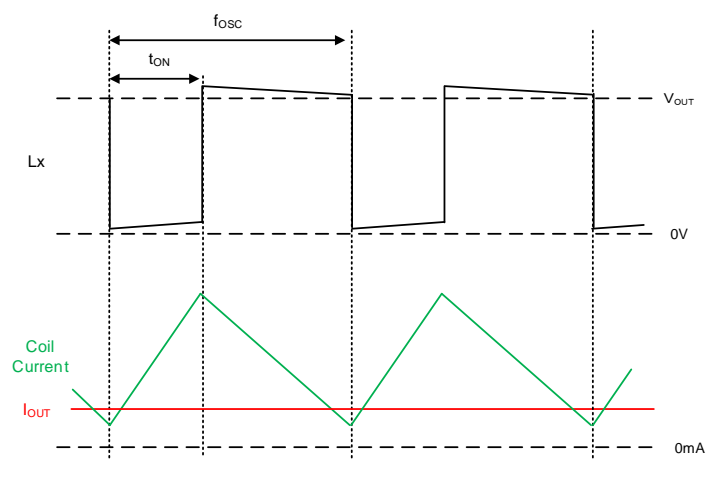

XC9143 Series : Example of heavy load operation

XC9144 Series

The XC9144 Series (PWM/PFM automatic switching control) lowers the switching frequency during light loads by turning on the Low side driver FET when the coil current reaches the PFM current (I_{PFM}). This operation reduces the loss during light loads and achieves high efficiency from light to heavy loads. As the output current increases, the switching frequency increases proportional to the output current, and when the switching frequency increases f_{osc} , the circuit switches from PFM control to PWM control and the switching frequency becomes fixed.

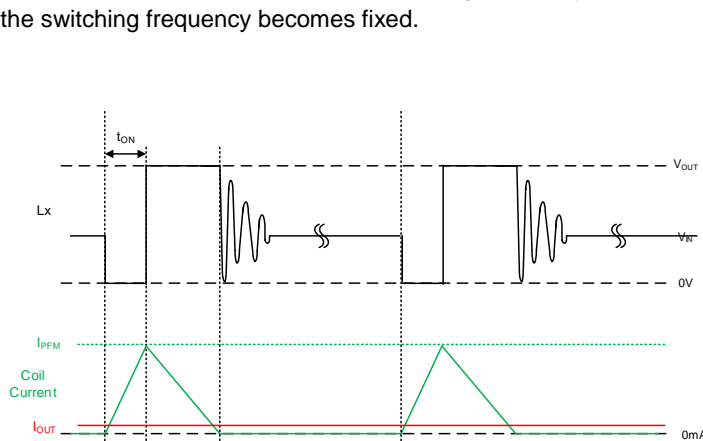

XC9144 Series : Example of light load operation

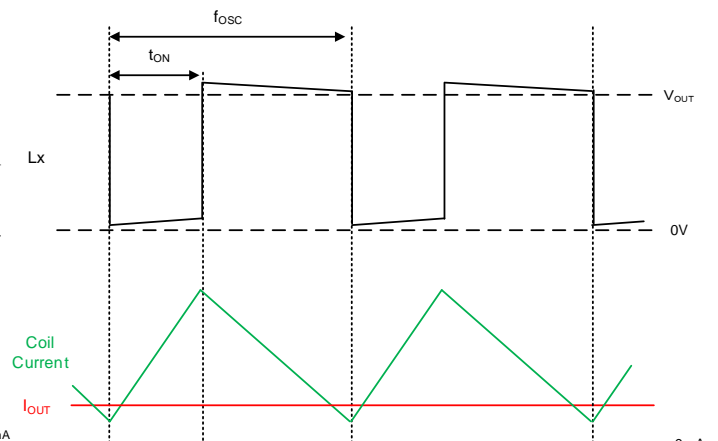

XC9144 Series : Example of heavy load operation

OPERATIONAL EXPLANATION

< EN function >

When an “L” voltage V_{ENL} (GND~0.3V) is input to the EN pin, the circuit enters the standby mode. The supply current is suppressed to the standby current I_{STB} (TYP. 5.0 μ A), boosting operation is stopped.

When the “H” voltage V_{ENH} (1.6V~16.0V) is input to the EN pin, the circuit enters the active mode. In the active mode, boosting operation is performed. When the EN voltage changes from the standby mode to the active mode, the startup operation that gradually increases the V_{OUT} voltage to V_{OUTSET} is started.

< Start Up function : Inrush current limit >

This function gradually starts up the V_{OUT} voltage from standby voltage to V_{OUTSET} to suppress the inrush current.

The startup operation starts when the standby mode changes to the active mode. The startup operation raises the output voltage while changing to the control method shown in ①~③ according to the V_{OUT} voltage.

① $V_{OUT} \leq 5V$: Low voltage detection state

When the V_{OUT} voltage in the standby state is 5V or less, the start-up circuit for low input voltage starts the boost operation. If the V_{OUT} voltage in the standby state is 5V or higher, the start-up circuit for low input voltage does not operate and starts from the operation ② shown below.

The low input start-up circuit boosts the V_{OUT} voltage by turn on the low side driver FET for a fixed period (TYP. 2.0 μ s) and a fixed on-time ($f_{OSC} = 1.2\text{MHz}$: TYP. 0.5 μ s, $f_{OSC} = 3.0\text{MHz}$: TYP. 0.3 μ s) only.

② $5V < V_{OUT} \leq V_{OUTSET} \times 0.95$

When the V_{OUT} voltage is higher than 5V, the boost operation shifts from the low input circuit to the PWM / PFM control circuit.

In the startup operation by the PWM / PFM control circuit, the detection value of the current limit function is set to $I_{LIM} \times 0.5$ and the boost operation is performed.

Since the V_{OUT} is lower than the set value, the error amplifier controls to lengthen the on-time of the Low Side driver, and the coil current also increases with this function. When the Low Side driver current reaches $I_{LIM} \times 0.5$, the current limiting function detects overcurrent and turns off the driver. In this way, the V_{OUT} is boosted while keeping the current limit set to $I_{LIM} \times 0.5$.

③ $V_{OUTSET} \times 0.95 < V_{OUT}$

When the V_{OUT} reaches $V_{OUTSET} \times 0.95$, the current limit detection value is changed from $I_{LIM} \times 0.5$ to I_{LIM} (TYP. 2A) to switch to normal operation.

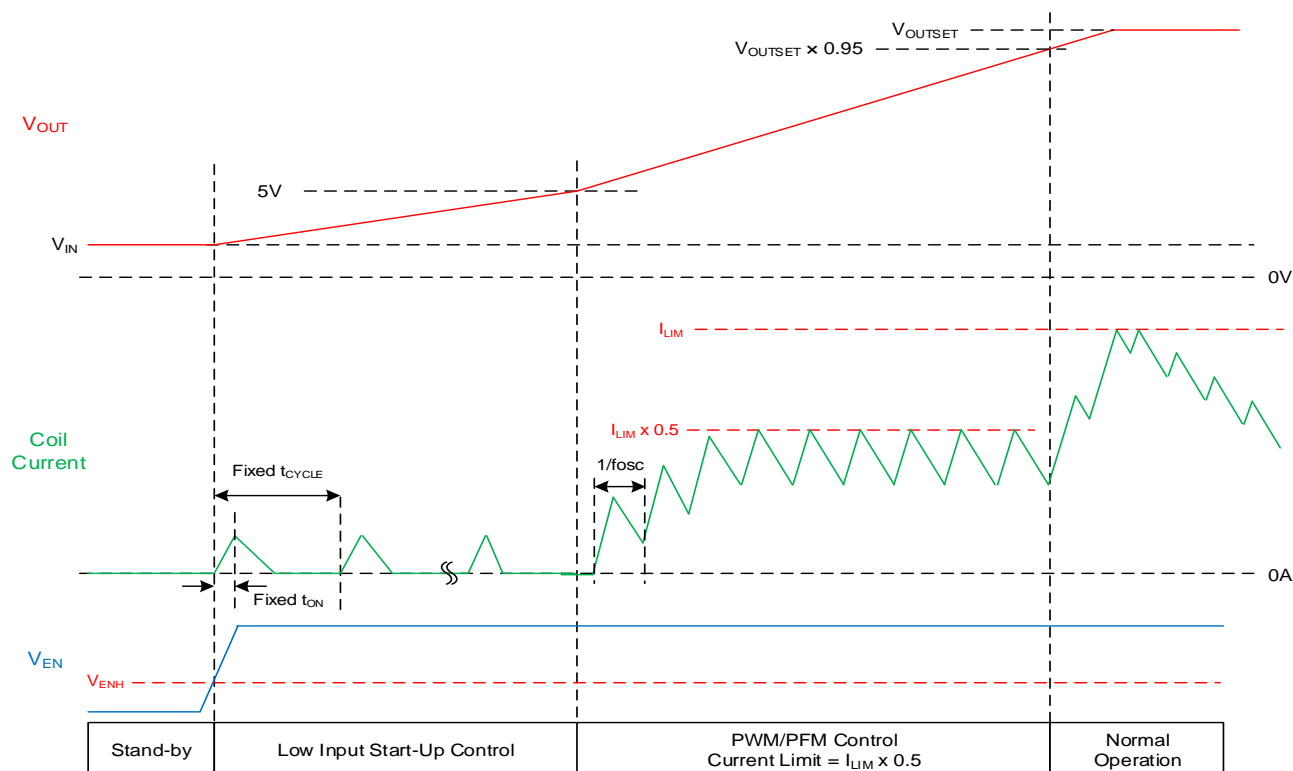

OPERATIONAL EXPLANATION

<Current limiting>

The current limiting circuit of the XC9143/XC9144 series monitor the current that flows through the Low side driver transistor every switching cycle, and when the current value reaches the limiting current I_{LIM} (TYP. 2.0A), the current limiting function activates.

When the over-current detection state is reached, the Low side driver transistor is turned off and the detection state is maintained during the switching cycle. When the next switching cycle begins, the detection state is released and the current limiting function resumes current monitoring.

If the current limit state (overload state) continues, the V_{OUT} will drop below the V_{OUTSET} . When the V_{OUT} is 5V or less, the output voltage of the internal regulator drops and the low voltage is detected.

The current limit function stops operating in the low voltage detection state, the low input startup circuit starts operating, and the startup operation starts. If the overload state is resolved, the V_{OUT} will automatically return to V_{OUTSET} . If the overload state is not resolved, the output voltage will not rise and the startup operation will continue. In addition, there is no latch operation related to low voltage detection.

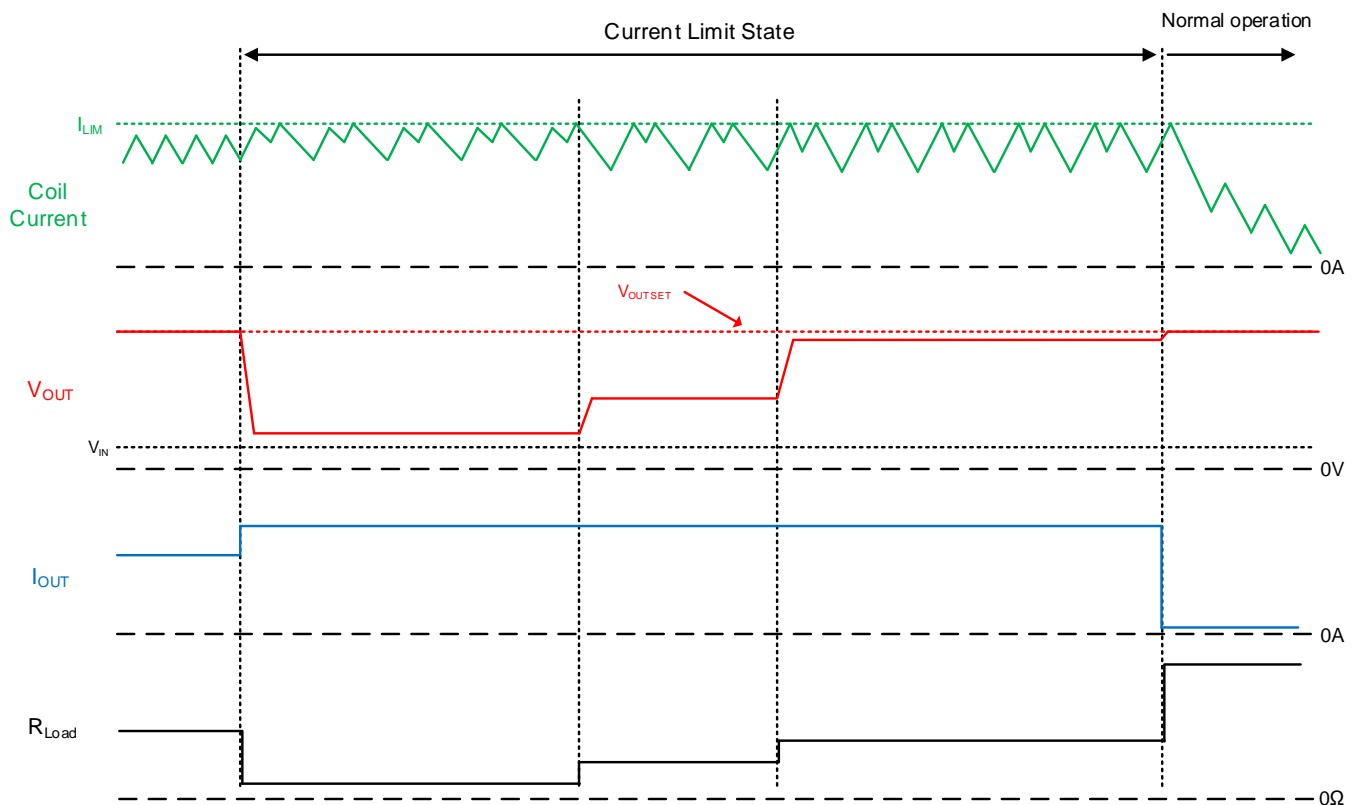

< Thermal Shutdown Function >

A thermal shutdown (TSD) function is built in for protection from overheating. When the junction temperature reaches the thermal shutdown detection temperature T_{TSD} , the overheat protection state is set and the boost operation is stopped. When the junction temperature drops to $T_{TSD} - T_{HYS}$, the overheat protection is canceled and the V_{OUT} is automatically returned to V_{OUTSET} through the startup operation.

V_{OUT} is lower than V_{OUTSET} in the overheat protection state, but if the V_{OUT} is 5V or less before the recovery operation is performed by releasing the overheat protection, the output voltage of the internal regulator drops and the low voltage is detected. Since the thermal shutdown function does not operate in the low voltage detection state, the overheat protection state is canceled and the automatic recovery operation by the low input startup starts.

■ NOTES ON USE

1) Recommended operating range (recommended setting range)

This IC can operate normally, and the recommended operating range differs depending on the product number. Please make sure that the power supply specifications are within the recommended operating range before using.

V_{OUTSET} - V_{IN} Recommended operating range (recommended setting range)

XC9143B10C (PWM, $f_{osc}=1.2\text{MHz}$)

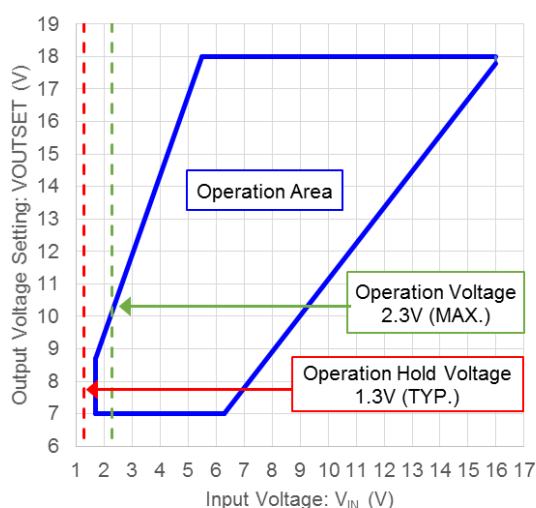

XC9144B10C (PWM/PFM, $f_{osc}=1.2\text{MHz}$)

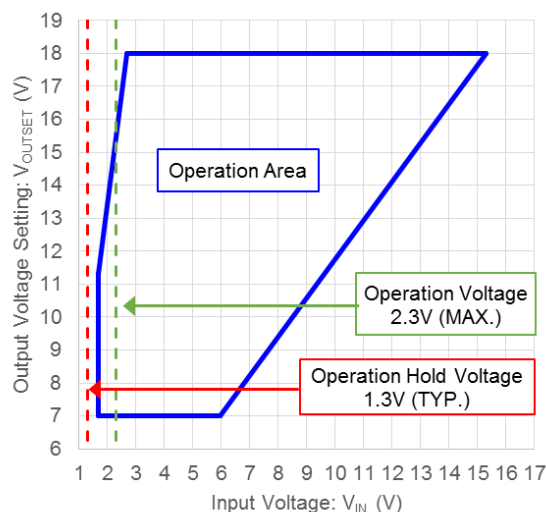

XC9143B10D, XC9144B10D ($f_{osc}=3.0\text{MHz}$)

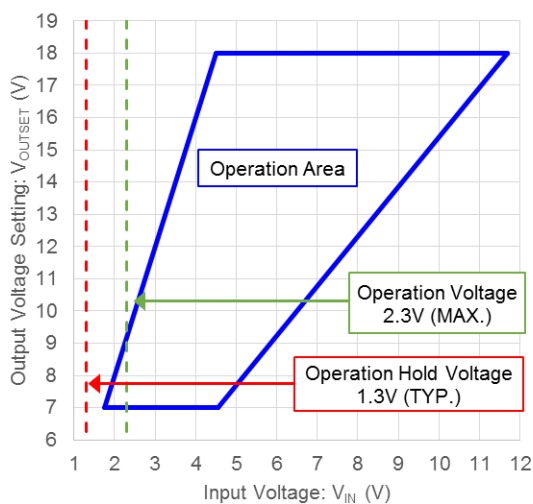

If it is used out of the recommended operation area, the following operations may occur and the IC may not operate normally.

Out of the recommended operation area

- (a) Under a high boost ratio, unstable operation may occur at heavy load.
However, if the output current of XC9144 series is sufficiently small and it operates in discontinuous mode, it may be possible to use it depending on the power supply conditions, so please contact us separately.
- (b) Under a low boost ratio, unstable operation may occur at heavy load.
- (c) When used in particularly small boost ratios, skip pulse may occur when the switching frequency becomes f_{osc} or less during PWM control mode, and the output voltage may become unstable.
- (d) If switching operation is performed while V_{IN} voltage is higher than V_{OUT} voltage, the coil current may be superimposed.

■ NOTES ON USE

- 2) For the phenomenon of temporal and transitional voltage decrease or voltage increase, the IC may be damaged or deteriorated if IC is used beyond the absolute MAX. specifications.
Also, if used under out of the recommended operating range, the IC may not operate normally or may cause deterioration.
- 3) Spike noise and ripple voltage arise in a switching regulator as with a DC/DC converter. These are greatly influenced by external component selection, such as the coil inductance, capacitance values, and board layout of external components. Once the design has been completed, verification with actual components should be done.
- 4) The DC/DC converter performance is greatly influenced by not only the ICs' characteristics, but also by those of the external components. Care must be taken when selecting the external components. Especially for C_L load capacitor, it is recommended to use type B capacitors(JIS regulation) or X7R, X5R capacitors (EIA regulation).
- 5) Depending on the detection delay time of the current limit circuit, a coil current exceeding the limit current value I_{LIM} may flow. Especially when operating conditions where the difference between the input and output voltage values is small, the required duty is low and the on-time of the Low side driver becomes short, and if this on-time becomes shorter than the delay time of the limit circuit, the current limit function will not work.
- 6) The output may oscillate if the current limit works. When the limiting function oscillates, the output oscillation cannot be eliminated unless the output current is reduced.
- 7) If V_{OUT} drops to around 5V due to overload, the maximum duty may drop as the power supply voltage of the internal circuit drops. When the duty increases to this reduced maximum duty, the operation stabilizes while V_{OUT} remains reduced, so even if the overload state is resolved, V_{OUT} does not automatically return to V_{OUTSET} .
- 8) Do not supply a current of several mA or more to the load through the parasitic diode of the High Side driver transistor. Even in the protected / standby state, a voltage is generated on the output side through the parasitic diode of the High Side driver transistor. Also, since the current flowing through the parasitic diode is not limited, if an overcurrent flows constantly through the parasitic diode, deterioration or destruction may occur due to overcurrent and heat generation.
- 9) If V_{IN} fluctuates greatly and sharply during standby, an overcurrent will flow to the C_L , so do not fluctuate the V_{IN} suddenly.
- 10) If 5V or higher is applied to the FB pin, it will enter test mode and normal operation will not be performed. Do not apply a voltage of 5V or more to the FB pin. Also, once the test mode is entered, the test mode will not be canceled even if "L" voltage is input to the EN pin. To cancel the test mode, set voltages to 0V in all the pin.
- 11) Torex places an importance on improving our products and their reliability. We request that users incorporate fail safe designs and post aging protection treatment when using Torex products in their systems.

■ NOTES ON USE

12) Instructions of pattern layouts.

Especially noted in the pattern layout are as follows.

Please refer to the reference pattern layout on the next page.

(a) Wire the large current line using thick, short connecting traces.

This makes it possible to reduce the wire impedance, which is expected to reduce noise and improve heat dissipation.

If the wire impedance of the large current line is large, it may cause noise or the IC to not operate normally.

(b) Place the input capacitance C_{IN} , output capacitance C_L , inductor L and IC which the large current flows on the same surface.

If they are placed on both sides, a large current will flow through Via, which has high impedance, it may cause noise and the IC may not operate normally.

(c) Please mount each external component as close to the IC as possible.

Especially place the output capacitance C_L near the IC and connect it with as low impedance as possible.

If the output capacity C_L and IC are too far apart, it may cause noise or the IC may not operate normally.

(d) The FB line connected to the FB pin is extremely sensitive to noise, so connect it with the shortest possible wire. If the FB line is long, the IC may not operate normally due to switching noise and external noise.

(e) Depending on the PCB layout, switching noise can reduce load stability.

In that case, take measures to reduce load stability by inserting a resistor R_{CFB} in series with the C_{FB} .

If the decrease in load stability does not improve with adding the R_{CFB} , place a ceramic capacitor C_{L6} of about 0.1 μ F to 1 μ F near the R_{FB1} .

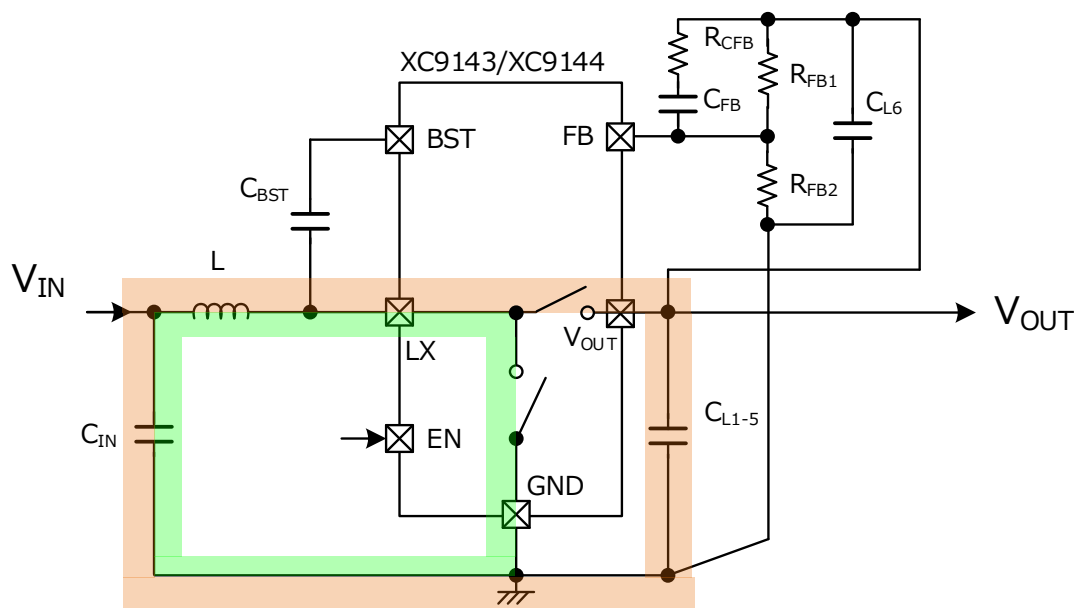

High Current Path @ High Side Driver ON

High Current Path @ Low Side Driver ON

<Pattern layout>

Layer 1

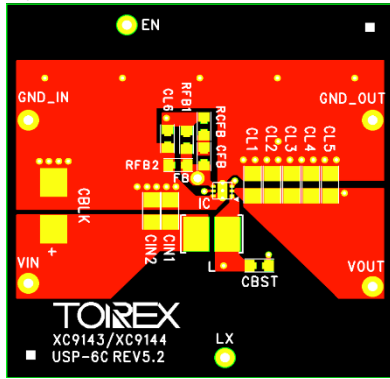

Layer 2

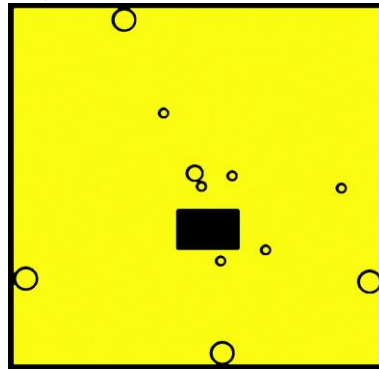

Layer 3

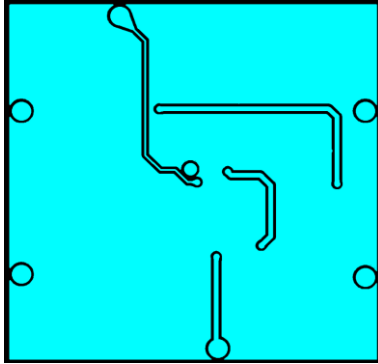

Layer 4

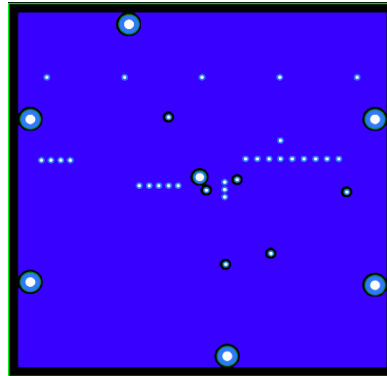

■ TYPICAL PERFORMANCE CHARACTERISTICS

(1) Efficiency vs. Output Current

XC9143B10C/XC9144B10C ($f_{osc}=1.2\text{MHz}$), $T_a=25^\circ\text{C}$

$V_{OUTSET}=7\text{V}$, $L=4.7\mu\text{H}$ (XGL4020-472ME)

$C_{IN}=4.7\mu\text{F}$ (GRM188R61E475K), $C_L=10\mu\text{F}$ (GRM188R61A106K x4)

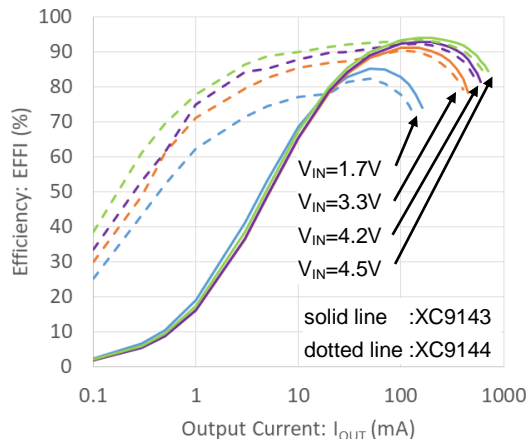

XC9143B10D/XC9144B10D ($f_{osc}=3.0\text{MHz}$), $T_a=25^\circ\text{C}$

$V_{OUTSET}=7\text{V}$, $L=2.2\mu\text{H}$ (XFL4020-222ME)

$C_{IN}=4.7\mu\text{F}$ (GRM188R61E475K), $C_L=10\mu\text{F}$ (GRM188R61A106K x4)

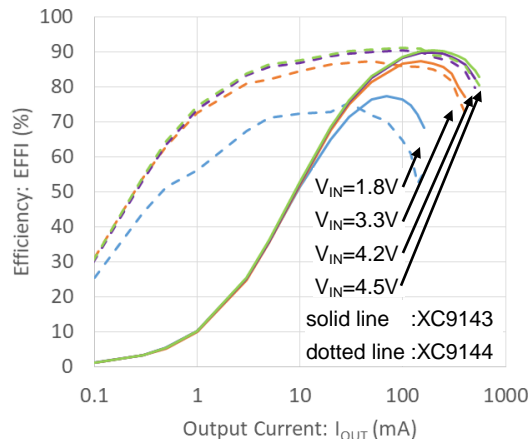

XC9143B10C/XC9144B10C ($f_{osc}=1.2\text{MHz}$), $T_a=25^\circ\text{C}$

$V_{OUTSET}=12\text{V}$, $L=4.7\mu\text{H}$ (XGL4020-472ME)

$C_{IN}=4.7\mu\text{F}$ (GRM188R61E475K), $C_L=10\mu\text{F}$ (GRM21BR61E106K x4)

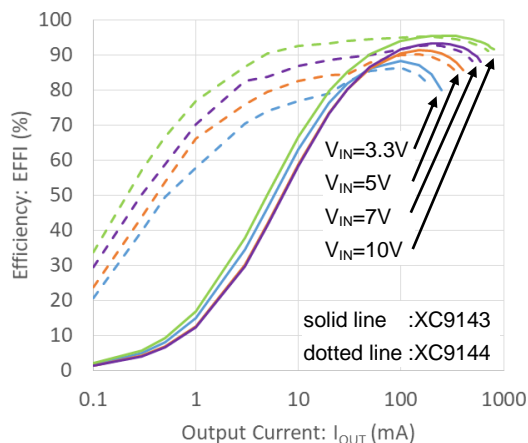

XC9143B10D/XC9144B10D ($f_{osc}=3.0\text{MHz}$), $T_a=25^\circ\text{C}$

$V_{OUTSET}=12\text{V}$, $L=2.2\mu\text{H}$ (XFL4020-222ME)

$C_{IN}=4.7\mu\text{F}$ (GRM188R61E475K), $C_L=10\mu\text{F}$ (GRM21BR61E106K x4)

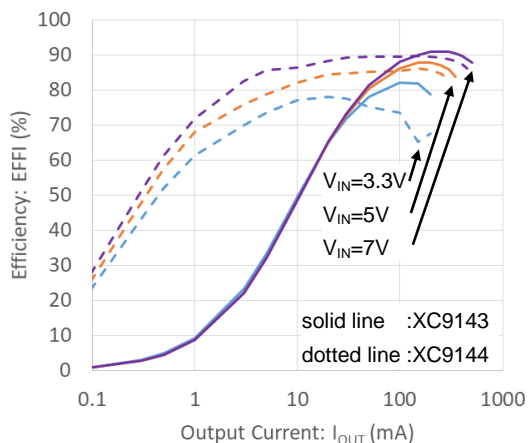

XC9143B10C/XC9144B10C ($f_{osc}=1.2\text{MHz}$), $T_a=25^\circ\text{C}$

$V_{OUTSET}=18\text{V}$, $L=4.7\mu\text{H}$ (XGL4020-472ME)

$C_{IN}=4.7\mu\text{F}$ (GRM188R61E475K), $C_L=10\mu\text{F}$ (GRM21BR61E106K x5)

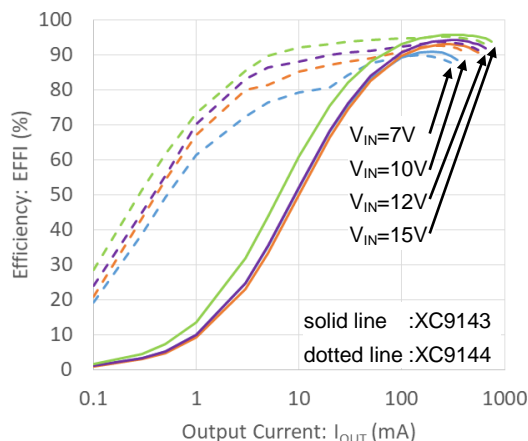

XC9143B10D/XC9144B10D ($f_{osc}=3.0\text{MHz}$), $T_a=25^\circ\text{C}$

$V_{OUTSET}=18\text{V}$, $L=2.2\mu\text{H}$ (XFL4020-222ME)

$C_{IN}=4.7\mu\text{F}$ (GRM188R61E475K), $C_L=10\mu\text{F}$ (GRM21BR61E106K x5)

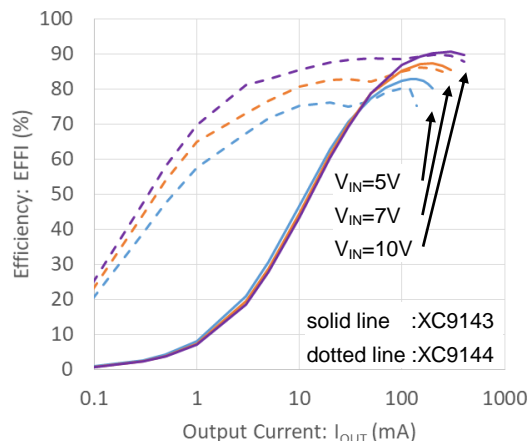

TYPICAL PERFORMANCE CHARACTERISTICS

(2) Output Voltage vs. Output Current

XC9143B10C/XC9144B10C ($f_{osc}=1.2\text{MHz}$, $T_a=25^\circ\text{C}$)

$V_{OUTSET}=7\text{V}$, $L=4.7\mu\text{H}$ (XGL4020-472ME)

$C_{IN}=4.7\mu\text{F}$ (GRM188R61E475K), $C_L=10\mu\text{F}$ (GRM188R61A106K x4)

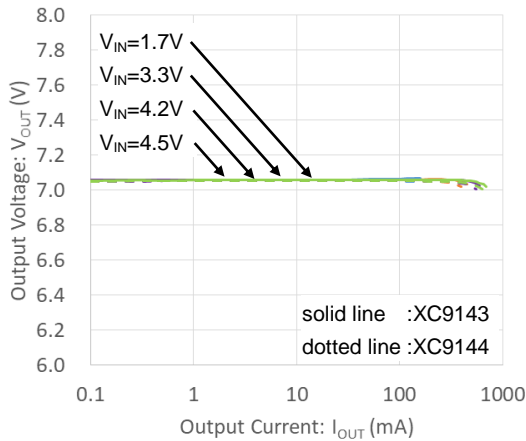

XC9143B10D/XC9144B10D ($f_{osc}=3.0\text{MHz}$, $T_a=25^\circ\text{C}$)

$V_{OUTSET}=7\text{V}$, $L=2.2\mu\text{H}$ (XFL4020-222ME)

$C_{IN}=4.7\mu\text{F}$ (GRM188R61E475K), $C_L=10\mu\text{F}$ (GRM188R61A106K x4)

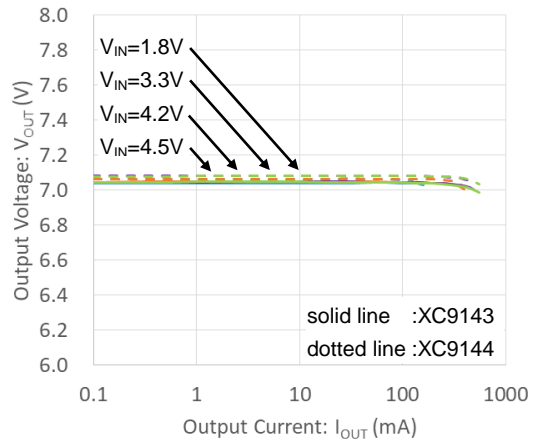

XC9143B10C/XC9144B10C ($f_{osc}=1.2\text{MHz}$, $T_a=25^\circ\text{C}$)

$V_{OUTSET}=12\text{V}$, $L=4.7\mu\text{H}$ (XGL4020-472ME)

$C_{IN}=4.7\mu\text{F}$ (GRM188R61E475K), $C_L=10\mu\text{F}$ (GRM21BR61E106K x4)

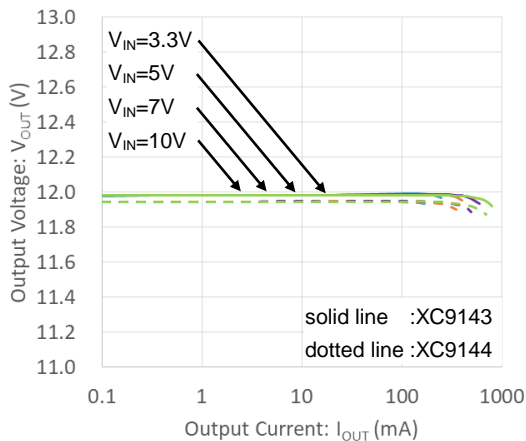

XC9143B10D/XC9144B10D ($f_{osc}=3.0\text{MHz}$, $T_a=25^\circ\text{C}$)

$V_{OUTSET}=12\text{V}$, $L=2.2\mu\text{H}$ (XFL4020-222ME)

$C_{IN}=4.7\mu\text{F}$ (GRM188R61E475K), $C_L=10\mu\text{F}$ (GRM21BR61E106K x4)

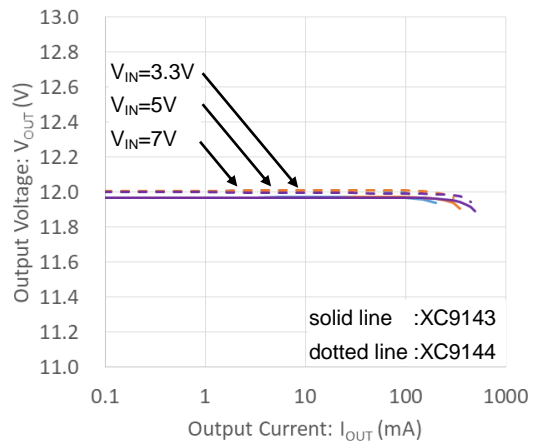

XC9143B10C/XC9144B10C ($f_{osc}=1.2\text{MHz}$, $T_a=25^\circ\text{C}$)

$V_{OUTSET}=18\text{V}$, $L=4.7\mu\text{H}$ (XGL4020-472ME)

$C_{IN}=4.7\mu\text{F}$ (GRM188R61E475K), $C_L=10\mu\text{F}$ (GRM21BR61E106K x5)

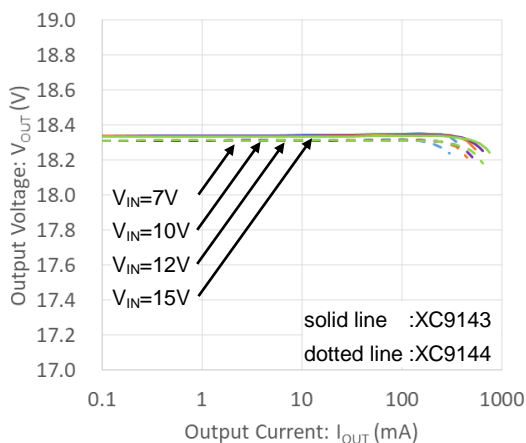

XC9143B10D/XC9144B10D ($f_{osc}=3.0\text{MHz}$, $T_a=25^\circ\text{C}$)

$V_{OUTSET}=18\text{V}$, $L=2.2\mu\text{H}$ (XFL4020-222ME)

$C_{IN}=4.7\mu\text{F}$ (GRM188R61E475K), $C_L=10\mu\text{F}$ (GRM21BR61E106K x5)

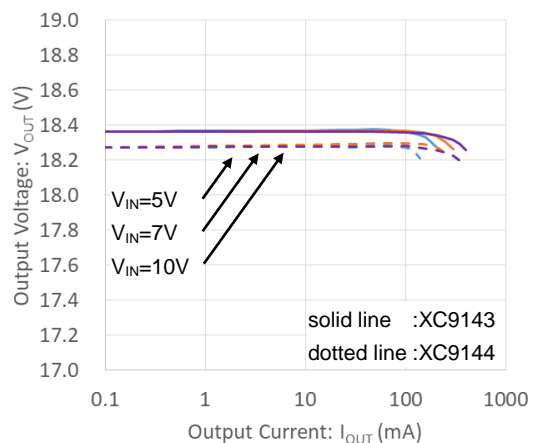

TYPICAL PERFORMANCE CHARACTERISTICS

(3) Ripple Voltage vs. Output Current

XC9143B10C/XC9144B10C ($f_{osc}=1.2\text{MHz}$, $T_a=25^\circ\text{C}$)

$V_{OUTSET}=7\text{V}$, $L=4.7\mu\text{H}$ (XGL4020-472ME)

$C_{IN}=4.7\mu\text{F}$ (GRM188R61E475K), $C_L=10\mu\text{F}$ (GRM188R61A106K x4)

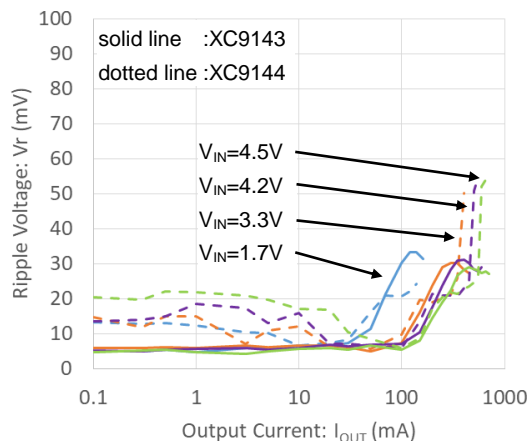

XC9143B10D/XC9144B10D ($f_{osc}=3.0\text{MHz}$, $T_a=25^\circ\text{C}$)

$V_{OUTSET}=7\text{V}$, $L=2.2\mu\text{H}$ (XFL4020-222ME)

$C_{IN}=4.7\mu\text{F}$ (GRM188R61E475K), $C_L=10\mu\text{F}$ (GRM188R61A106K x4)

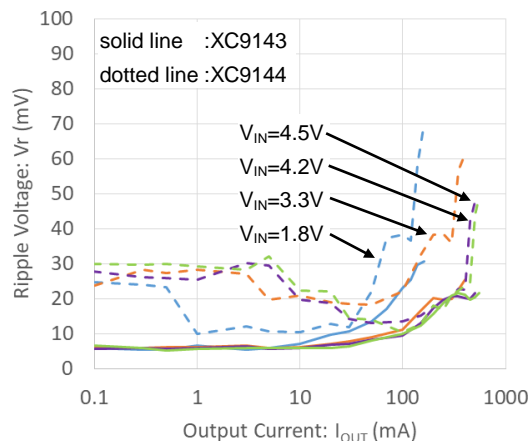

XC9143B10C/XC9144B10C ($f_{osc}=1.2\text{MHz}$, $T_a=25^\circ\text{C}$)

$V_{OUTSET}=12\text{V}$, $L=4.7\mu\text{H}$ (XGL4020-472ME)

$C_{IN}=4.7\mu\text{F}$ (GRM188R61E475K), $C_L=10\mu\text{F}$ (GRM21BR61E106K x4)

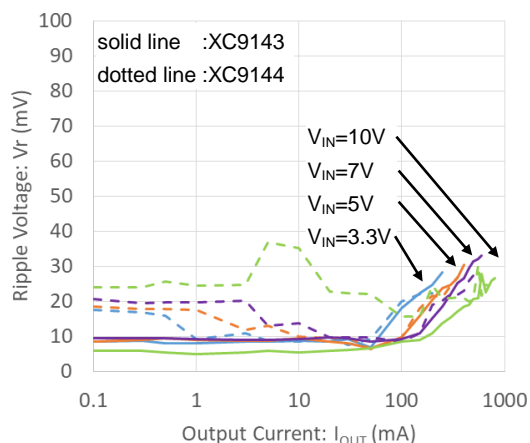

XC9143B10D/XC9144B10D ($f_{osc}=3.0\text{MHz}$, $T_a=25^\circ\text{C}$)

$V_{OUTSET}=12\text{V}$, $L=2.2\mu\text{H}$ (XFL4020-222ME)

$C_{IN}=4.7\mu\text{F}$ (GRM188R61E475K), $C_L=10\mu\text{F}$ (GRM21BR61E106K x4)

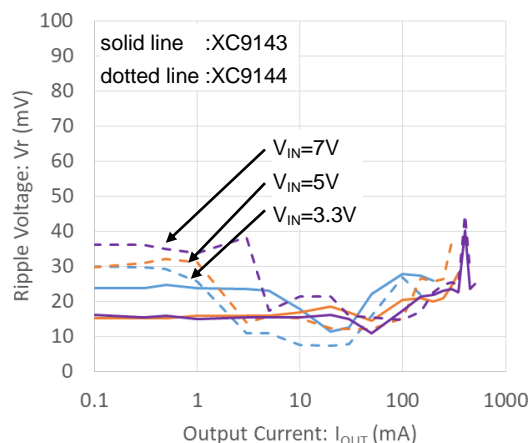

XC9143B10C/XC9144B10C ($f_{osc}=1.2\text{MHz}$, $T_a=25^\circ\text{C}$)

$V_{OUTSET}=18\text{V}$, $L=4.7\mu\text{H}$ (XGL4020-472ME)

$C_{IN}=4.7\mu\text{F}$ (GRM188R61E475K), $C_L=10\mu\text{F}$ (GRM21BR61E106K x5)

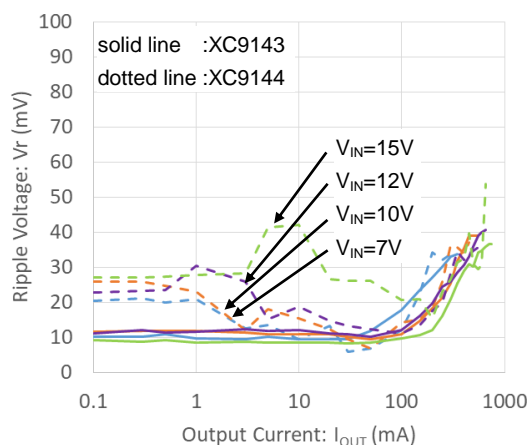

XC9143B10D/XC9144B10D ($f_{osc}=3.0\text{MHz}$, $T_a=25^\circ\text{C}$)

$V_{OUTSET}=18\text{V}$, $L=2.2\mu\text{H}$ (XFL4020-222ME)

$C_{IN}=4.7\mu\text{F}$ (GRM188R61E475K), $C_L=10\mu\text{F}$ (GRM21BR61E106K x5)

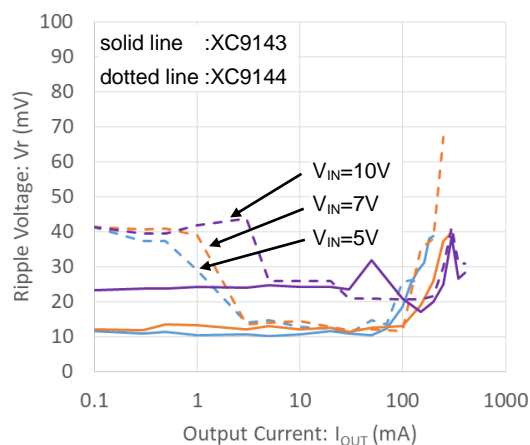

TYPICAL PERFORMANCE CHARACTERISTICS

(4) FB Voltage vs Ambient Temperature

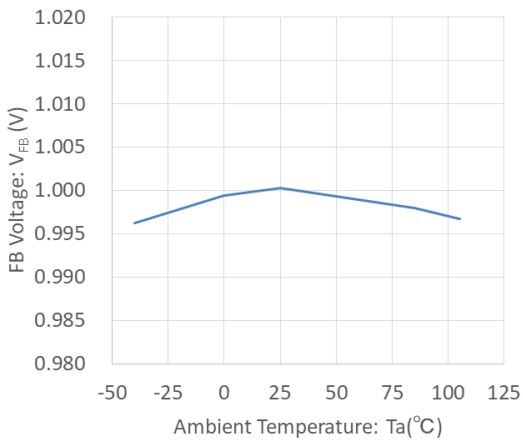

(5) Stand-by Current vs Ambient Temperature

$V_{OUT}=7.0V / 12V / 18V$

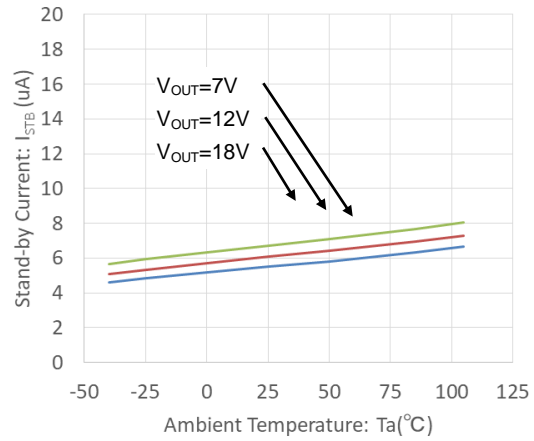

(6) Quiescent Current vs Ambient Temperature

$V_{OUT}=7.0V / 12V / 18V$

XC9144B10C (PWM/PFM, $f_{osc}=1.2MHz$)

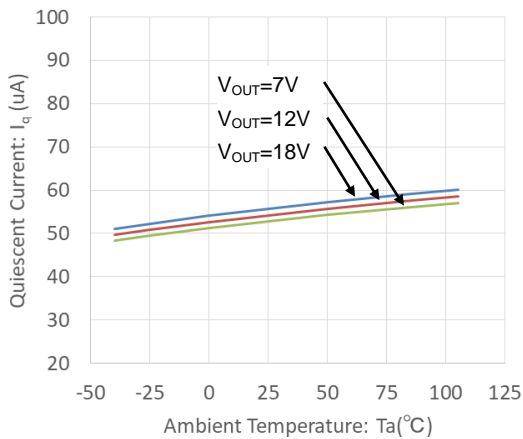

XC9144B10D (PWM/PFM, $f_{osc}=3.0MHz$)

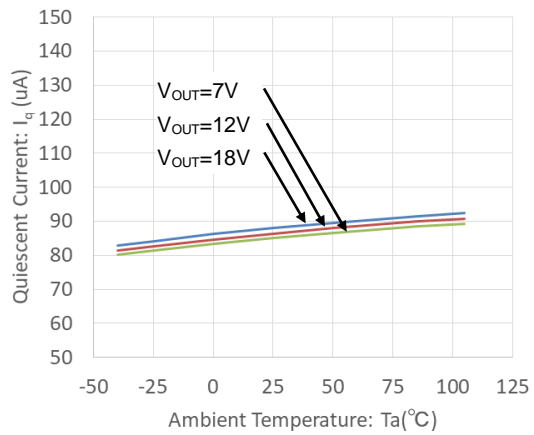

XC9143B10C (PWM, $f_{osc}=1.2MHz$)

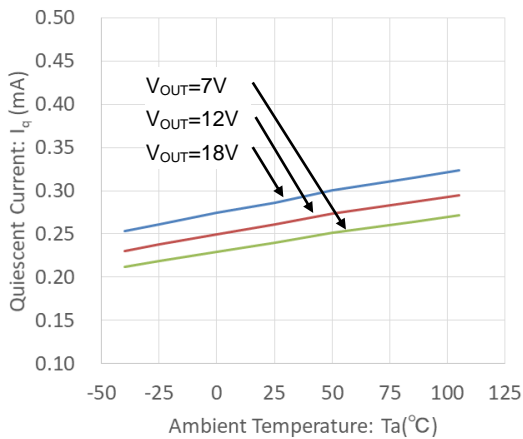

XC9143B10D (PWM/PFM, $f_{osc}=3.0MHz$)

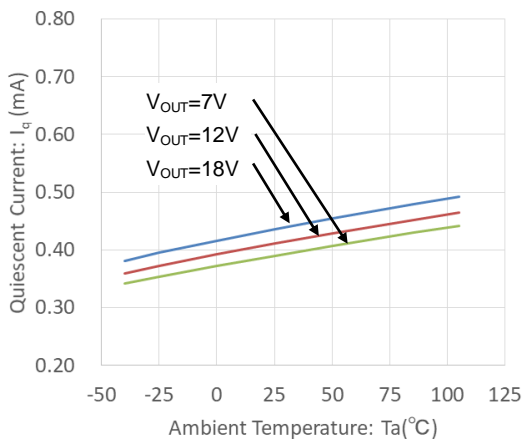

TYPICAL PERFORMANCE CHARACTERISTICS

(7) EN "H" Voltage vs Ambient Temperature

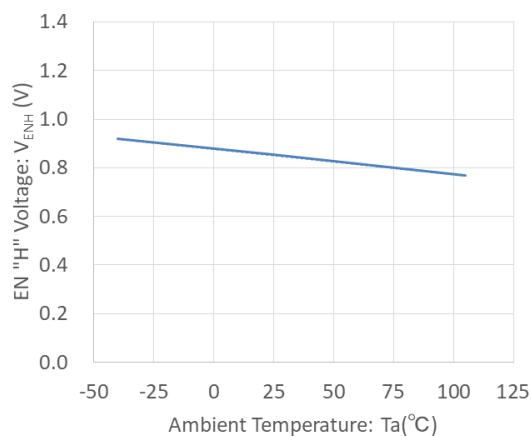

(8) EN "L" Voltage vs Ambient Temperature

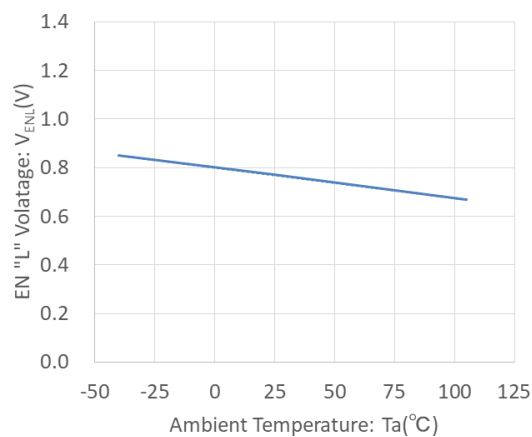

(9) EN "H" Current vs Ambient Temperature

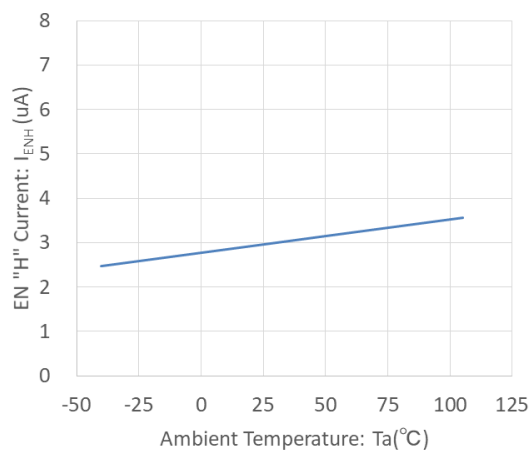

(10) EN "L" Current vs Ambient Temperature

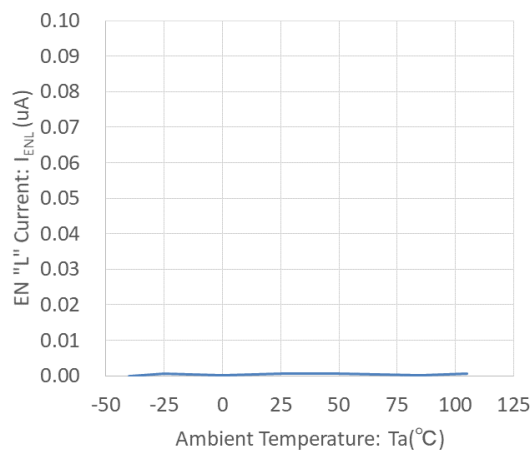

(11) FB "H" Current vs Ambient Temperature

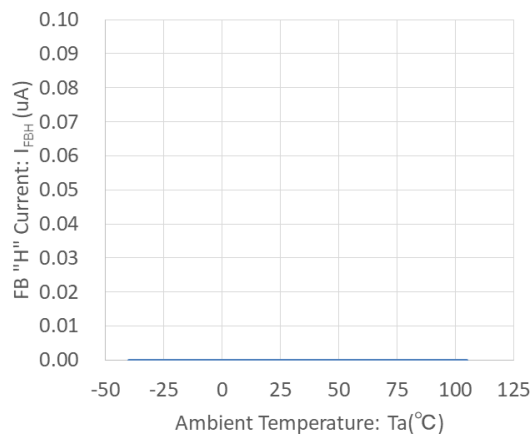

(12) FB "L" Current vs Ambient Temperature

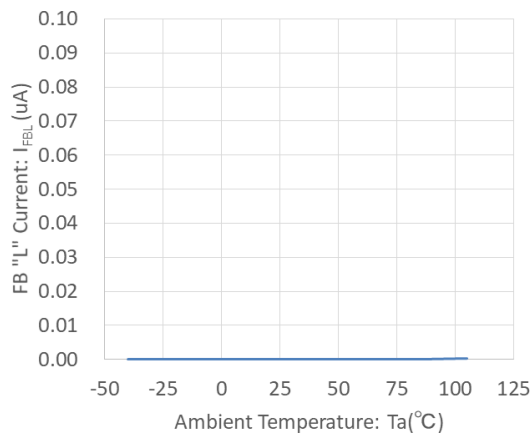

TYPICAL PERFORMANCE CHARACTERISTICS

(13) Lx SW "H" Leakage Current vs Ambient Temperature

$V_{LX}=0V$, $V_{OUT}=8V / 12V / 16V / 20V$

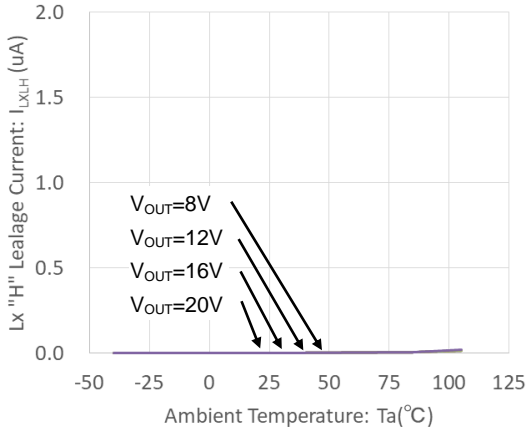

(14) Lx SW "L" Leakage Current vs Ambient Temperature

$V_{LX}=8V / 12V / 16V / 20V$

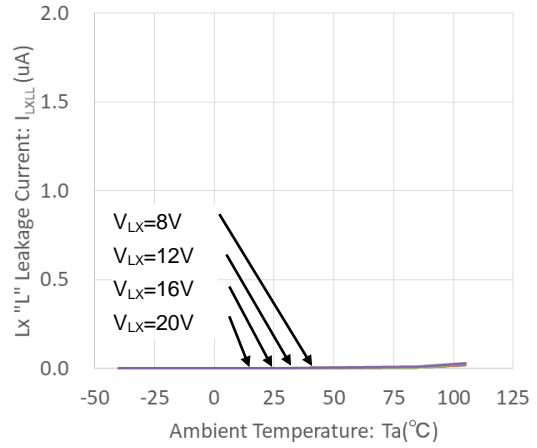

(15) LX SW "H" On Resistance vs Ambient Temperature

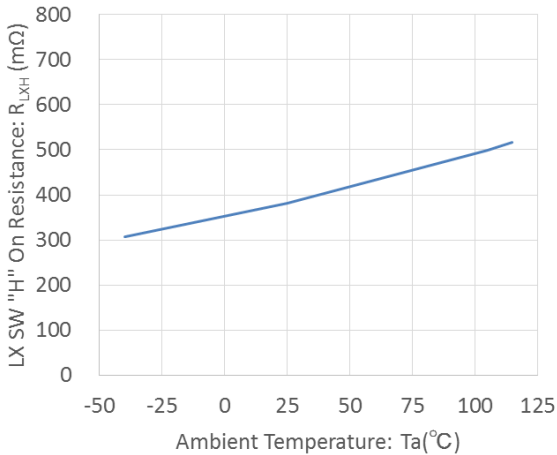

(16) LX SW "L" On Resistance vs Ambient Temperature

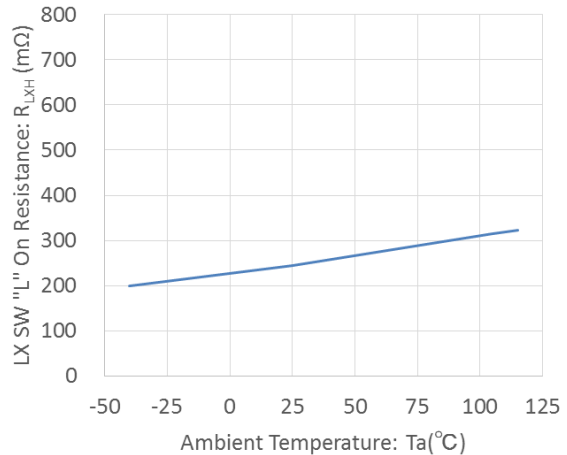

(17) Oscillation Frequency vs Ambient Temperature

$V_{OUT}=8V$

XC9143B10C/XC9144B10C ($f_{OSC}=1.2MHz$)

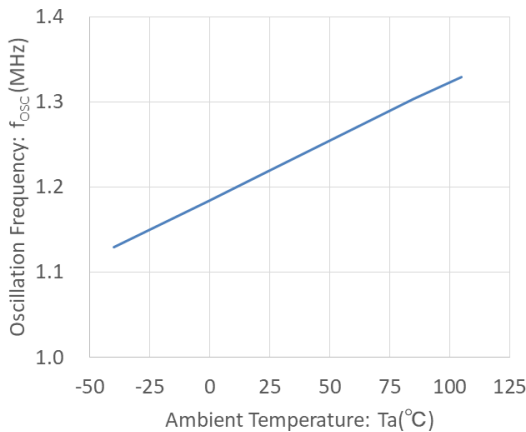

XC9143B10D/XC9144B10D ($f_{OSC}=3.0MHz$)

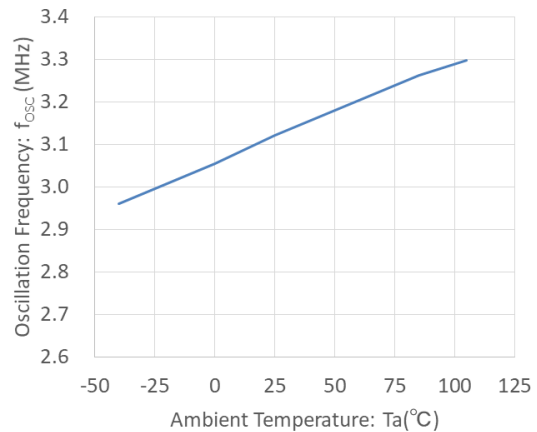

TYPICAL PERFORMANCE CHARACTERISTICS

(18) Maximum Duty Cycle vs Ambient Temperature

$V_{OUT}=8V$

XC9143B10C/XC9144B10C ($f_{OSC}=1.2MHz$)

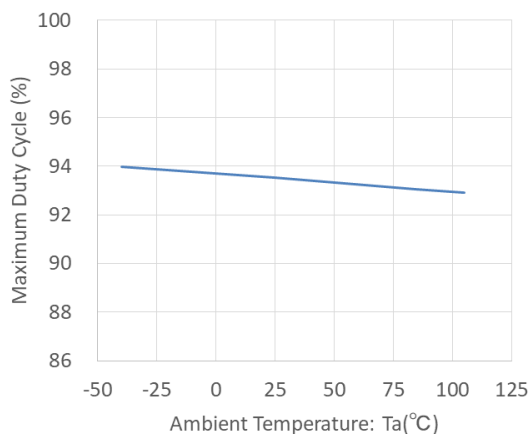

XC9143B10D/XC9144B10D ($f_{OSC}=3.0MHz$)

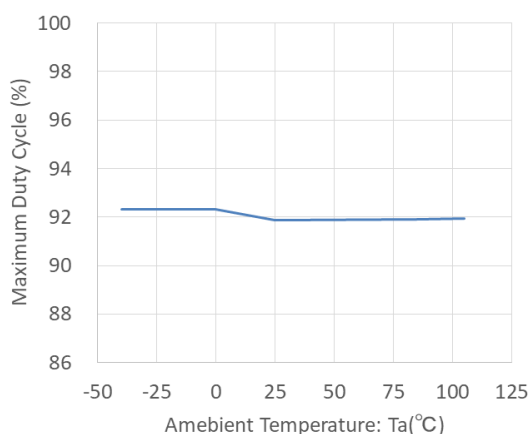

(19) PFM Switching Current vs Input Voltage

$V_{IN}=2V\sim 16V$

XC9144B10C ($f_{OSC}=1.2MHz$, $L=4.7\mu H(XGL4020-472ME)$)

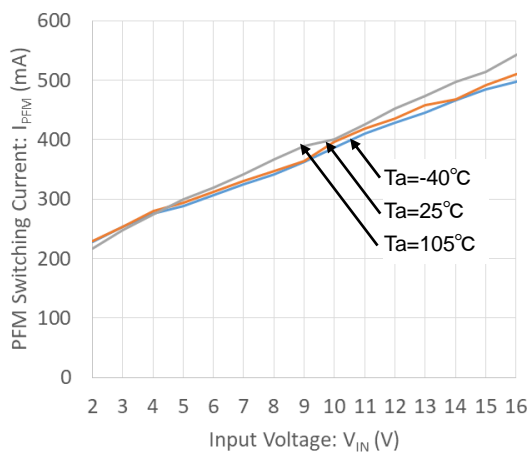

$V_{IN}=2V\sim 11.7V$

XC9144B10D ($f_{OSC}=3.0MHz$, $L=2.2\mu H(XFL4020-222ME)$)

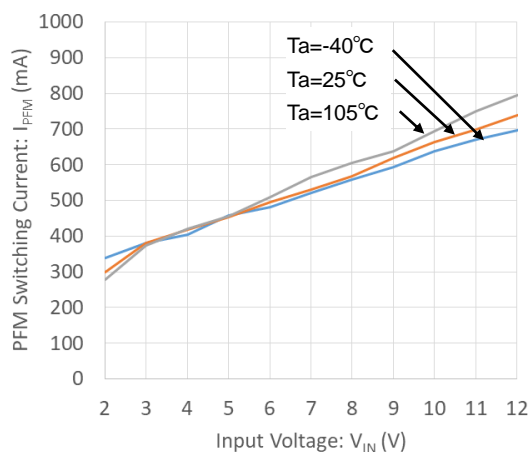

(20) Current Limit vs Input Voltage

$V_{IN}=2V\sim 16V$

XC9143B10C/XC9144B10C ($f_{OSC}=1.2MHz$)

$L=4.7\mu H(XGL4020-472ME)$

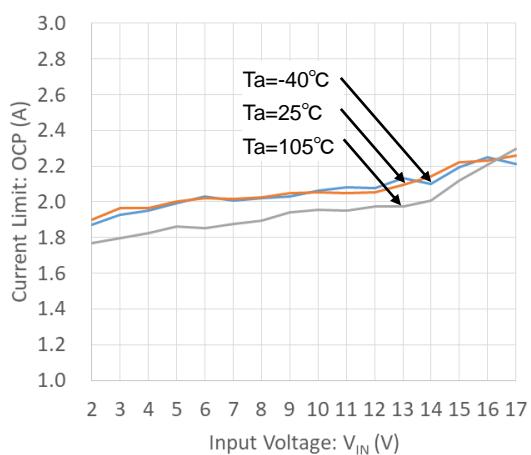

$V_{IN}=2V\sim 11.7V$

XC9143B10D/XC9144B10D ($f_{OSC}=3.0MHz$),

$L=2.2\mu H(XFL4020-222ME)$

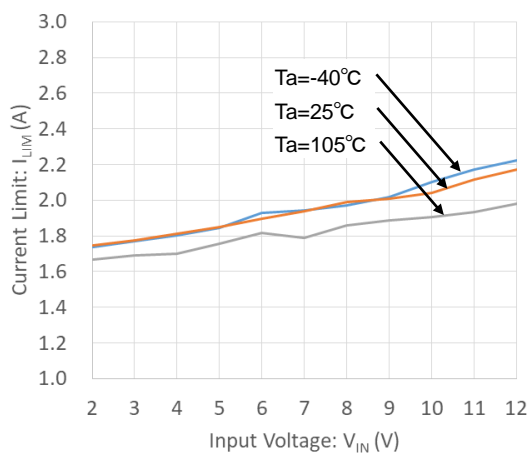

TYPICAL PERFORMANCE CHARACTERISTICS

(21) Operation Start Voltage vs Ambient Temperature

$V_{OUTSET}=7V$

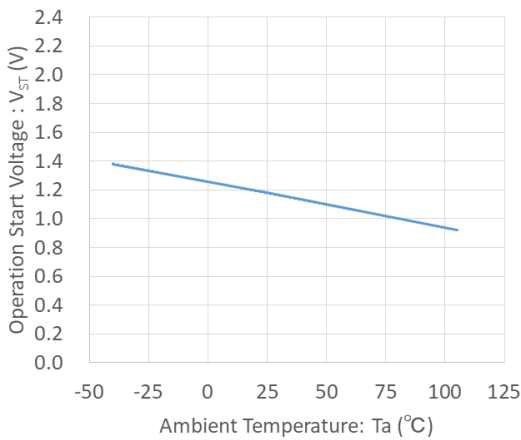

(22) Operation Hold Voltage vs Ambient Temperature

$V_{OUTSET}=10V / 14V / 18V$

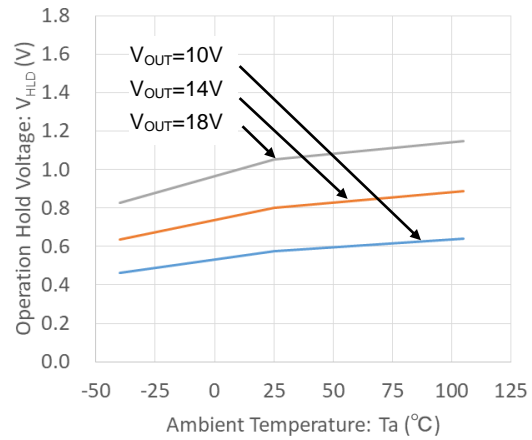

(23) Start-Up Time vs Ambient Temperature

XC9143B10C/XC9144B10C ($f_{OSC}=1.2MHz$)

$V_{OUTSET}=7.0V$, $V_{IN}=3.3V$, $I_{OUT}=0mA$, $L=4.7\mu H(XGL4020-472ME)$
 $C_{IN}=4.7\mu F(GRM188R61E475K)$, $C_L=10\mu F(GRM188R61A106K \times 4)$

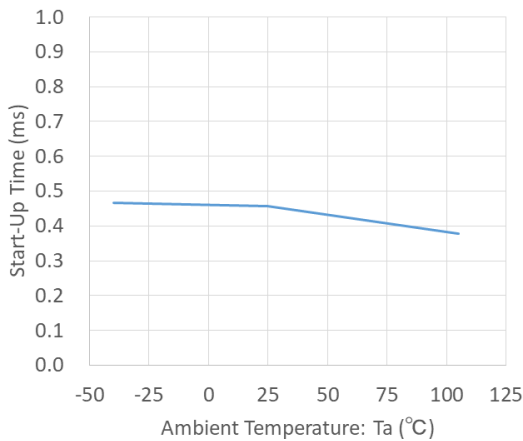

XC9143B10D/XC9144B10D ($f_{OSC}=3.0MHz$)

$V_{OUTSET}=7.0V$, $V_{IN}=3.3V$, $I_{OUT}=0mA$, $L=2.2\mu H(XFL4020-222ME)$
 $C_{IN}=4.7\mu F(GRM188R61E475K)$, $C_L=10\mu F(GRM188R61A106K \times 4)$

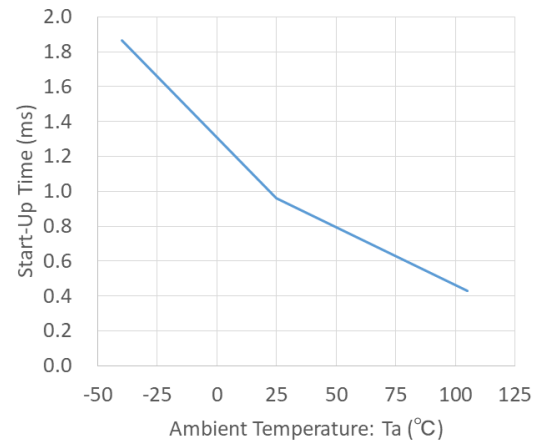

XC9143B10C/XC9144B10C ($f_{OSC}=1.2MHz$)

$V_{OUTSET}=12V$, $V_{IN}=5.0V$, $I_{OUT}=0mA$, $L=4.7\mu H(XGL4020-472ME)$
 $C_{IN}=4.7\mu F(GRM188R61E475K)$, $C_L=10\mu F(GRM21BR61E106K \times 4)$

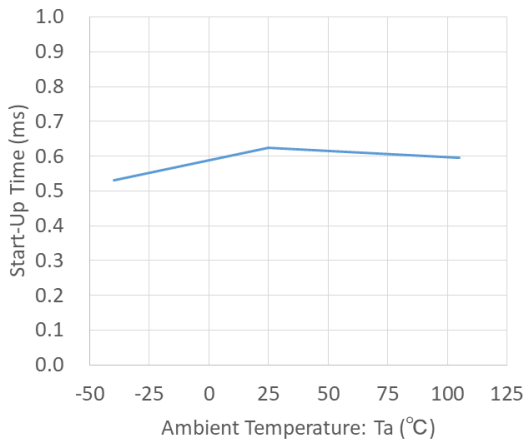

XC9143B10D/XC9144B10D ($f_{OSC}=3.0MHz$)

$V_{OUTSET}=12V$, $V_{IN}=5.0V$, $I_{OUT}=0mA$, $L=2.2\mu H(XFL4020-222ME)$
 $C_{IN}=4.7\mu F(GRM188R61E475K)$, $C_L=10\mu F(GRM21BR61E106K \times 4)$

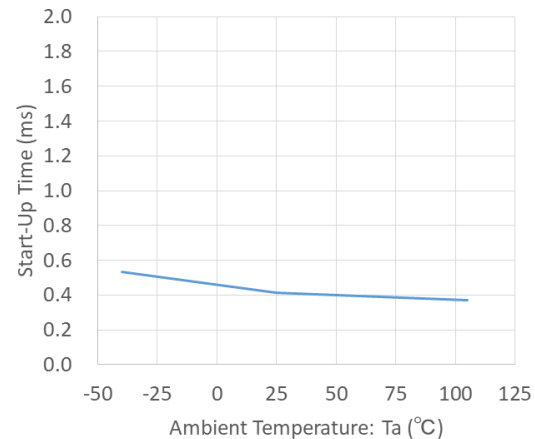

TYPICAL PERFORMANCE CHARACTERISTICS

(24) Load Transient Response

XC9143B10C(PWM, $f_{OSC}=1.2\text{MHz}$), $T_a=25^\circ\text{C}$

$V_{OUTSET}=7\text{V}$, $V_{IN}=3.3\text{V}$, $I_{OUT}=10\text{mA}\leftrightarrow 220\text{mA}$ (Slew Rate= $2.0\text{A}/\mu\text{s}$)

$L=4.7\mu\text{H}$ (XGL4020-472ME)

$C_{IN}=4.7\mu\text{F}$ (GRM188R61E475K), $C_L=10\mu\text{F}$ (GRM188R61A106K x4)

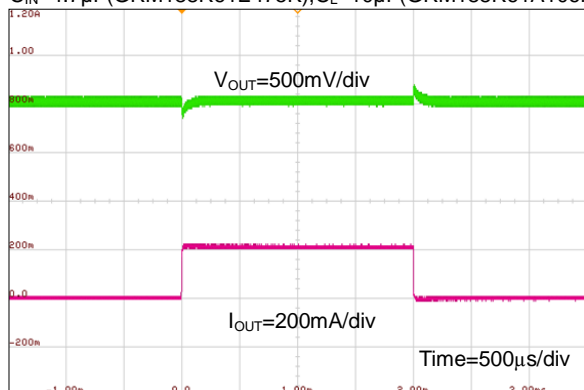

XC9144B10C(PWM/PFM, $f_{OSC}=1.2\text{MHz}$), $T_a=25^\circ\text{C}$

$V_{OUTSET}=7\text{V}$, $V_{IN}=3.3\text{V}$, $I_{OUT}=0\text{mA}\leftrightarrow 200\text{mA}$ (Slew Rate= $2.0\text{A}/\mu\text{s}$)

$L=4.7\mu\text{H}$ (XGL4020-472ME)

$C_{IN}=4.7\mu\text{F}$ (GRM188R61E475K), $C_L=10\mu\text{F}$ (GRM188R61A106K x4)

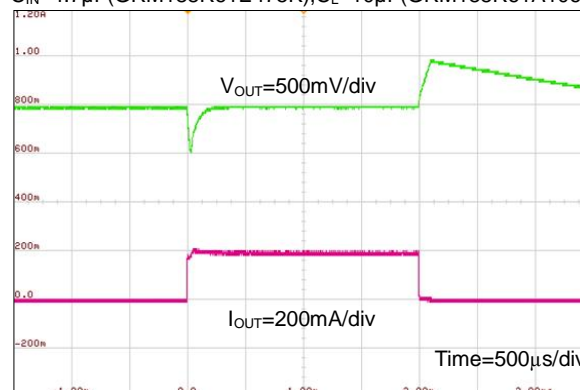

XC9143B10C(PWM, $f_{OSC}=1.2\text{MHz}$), $T_a=25^\circ\text{C}$

$V_{OUTSET}=12\text{V}$, $V_{IN}=5\text{V}$, $I_{OUT}=10\text{mA}\leftrightarrow 220\text{mA}$ (Slew Rate= $2.0\text{A}/\mu\text{s}$)

$L=4.7\mu\text{H}$ (XGL4020-472ME)

$C_{IN}=4.7\mu\text{F}$ (GRM188R61E475K), $C_L=10\mu\text{F}$ (GRM21BR61E106K x4)

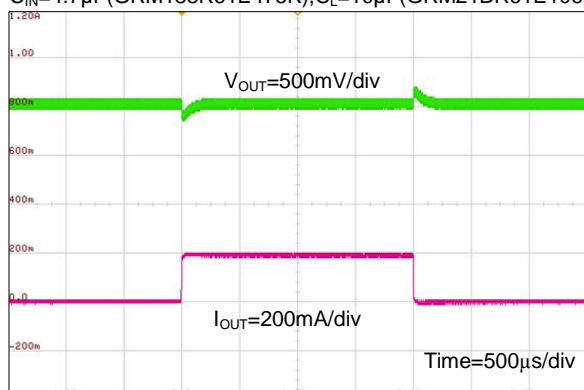

XC9144B10C(PWM/PFM, $f_{OSC}=1.2\text{MHz}$), $T_a=25^\circ\text{C}$

$V_{OUTSET}=12\text{V}$, $V_{IN}=5\text{V}$, $I_{OUT}=0\text{mA}\leftrightarrow 200\text{mA}$ (Slew Rate= $2.0\text{A}/\mu\text{s}$)

$L=4.7\mu\text{H}$ (XGL4020-472ME)

$C_{IN}=4.7\mu\text{F}$ (GRM188R61E475K), $C_L=10\mu\text{F}$ (GRM21BR61E106K x4)

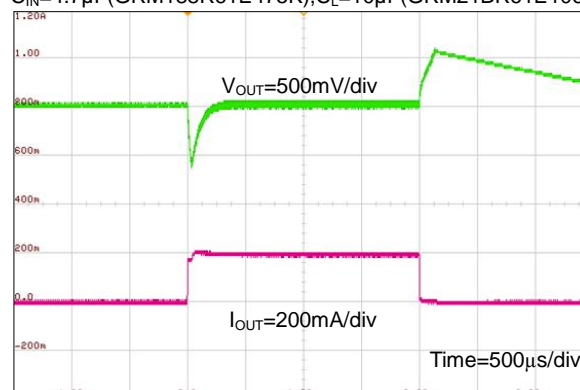

XC9143B10C(PWM, $f_{OSC}=1.2\text{MHz}$), $T_a=25^\circ\text{C}$

$V_{OUTSET}=18\text{V}$, $V_{IN}=7\text{V}$, $I_{OUT}=10\text{mA}\leftrightarrow 180\text{mA}$ (Slew Rate= $2.0\text{A}/\mu\text{s}$)

$L=4.7\mu\text{H}$ (XGL4020-472ME)

$C_{IN}=4.7\mu\text{F}$ (GRM188R61E475K), $C_L=10\mu\text{F}$ (GRM21BR61E106K x5)

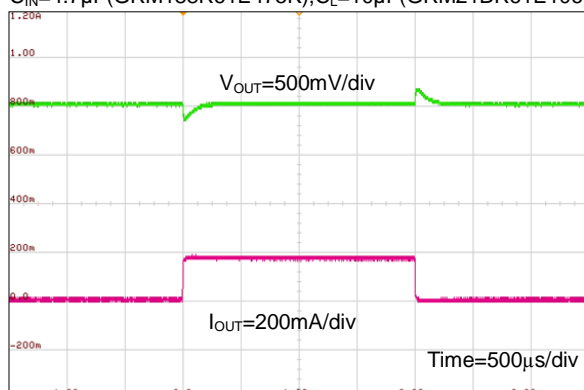

XC9144B10C(PWM/PFM, $f_{OSC}=1.2\text{MHz}$), $T_a=25^\circ\text{C}$

$V_{OUTSET}=18\text{V}$, $V_{IN}=7\text{V}$, $I_{OUT}=20\text{mA}\leftrightarrow 200\text{mA}$ (Slew Rate= $2.0\text{A}/\mu\text{s}$)

$L=4.7\mu\text{H}$ (XGL4020-472ME)

$C_{IN}=4.7\mu\text{F}$ (GRM188R61E475K), $C_L=10\mu\text{F}$ (GRM21BR61E106K x5)

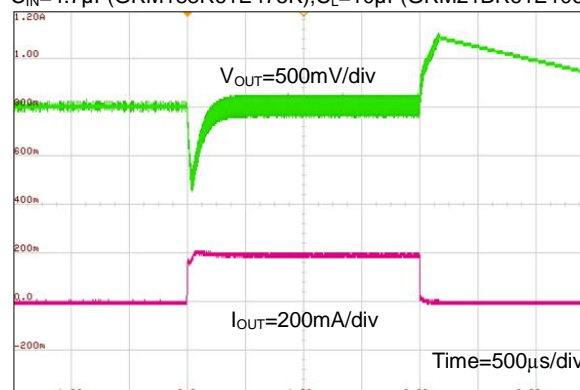

TYPICAL PERFORMANCE CHARACTERISTICS

XC9143B10D(PWM, $f_{osc}=3.0\text{MHz}$), $T_a=25^\circ\text{C}$

$V_{OUTSET}=7\text{V}$, $V_{IN}=3.3\text{V}$, $I_{OUT}=10\text{mA}\leftrightarrow 210\text{mA}$ (Slew Rate= $2.0\text{A}/\mu\text{s}$)

$L=2.2\mu\text{H}$ (XFL4020-222ME)

$C_{IN}=4.7\mu\text{F}$ (GRM188R61E475K), $C_L=10\mu\text{F}$ (GRM188R61A106K x4)

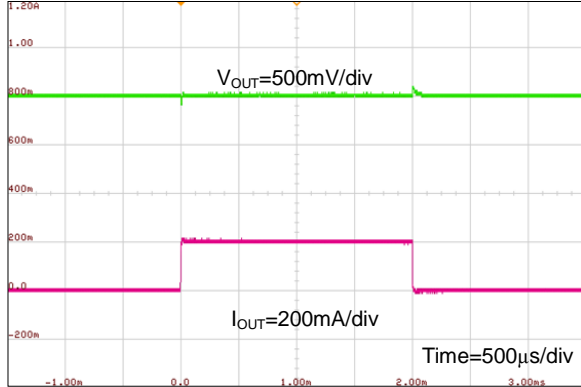

XC9144B10D(PWM/PFM, $f_{osc}=3.0\text{MHz}$), $T_a=25^\circ\text{C}$

$V_{OUTSET}=7\text{V}$, $V_{IN}=3.3\text{V}$, $I_{OUT}=0\text{mA}\leftrightarrow 200\text{mA}$ (Slew Rate= $2.0\text{A}/\mu\text{s}$)

$L=2.2\mu\text{H}$ (XFL4020-222ME)

$C_{IN}=4.7\mu\text{F}$ (GRM188R61E475K), $C_L=10\mu\text{F}$ (GRM188R61A106K x4)

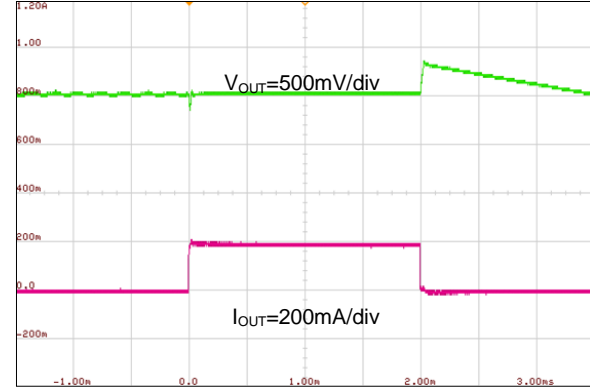

XC9143B10D(PWM, $f_{osc}=3.0\text{MHz}$), $T_a=25^\circ\text{C}$

$V_{OUTSET}=12\text{V}$, $V_{IN}=5\text{V}$, $I_{OUT}=10\text{mA}\leftrightarrow 190\text{mA}$ (Slew Rate= $2.0\text{A}/\mu\text{s}$)

$L=2.2\mu\text{H}$ (XFL4020-222ME)

$C_{IN}=4.7\mu\text{F}$ (GRM188R61E475K), $C_L=10\mu\text{F}$ (GRM21BR61E106K x4)

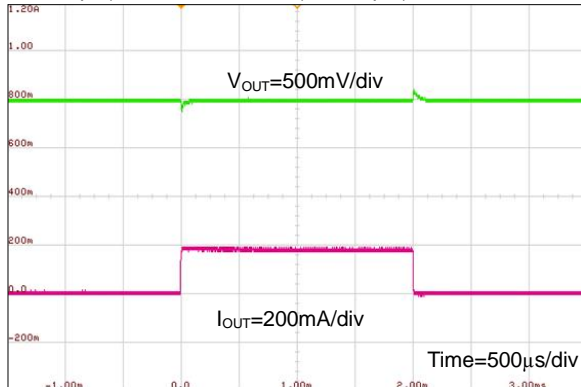

XC9144B10D(PWM/PFM, $f_{osc}=3.0\text{MHz}$), $T_a=25^\circ\text{C}$

$V_{OUTSET}=12\text{V}$, $V_{IN}=5\text{V}$, $I_{OUT}=0\text{mA}\leftrightarrow 190\text{mA}$ (Slew Rate= $2.0\text{A}/\mu\text{s}$)

$L=2.2\mu\text{H}$ (XFL4020-222ME)

$C_{IN}=4.7\mu\text{F}$ (GRM188R61E475K), $C_L=10\mu\text{F}$ (GRM21BR61E106K x4)

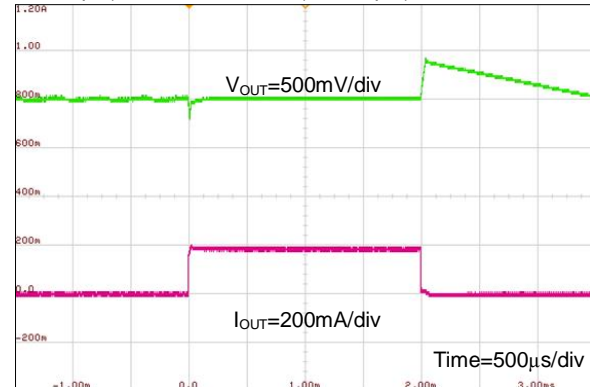

XC9143B10D(PWM, $f_{osc}=3.0\text{MHz}$), $T_a=25^\circ\text{C}$

$V_{OUTSET}=18\text{V}$, $V_{IN}=7\text{V}$, $I_{OUT}=10\text{mA}\leftrightarrow 170\text{mA}$ (Slew Rate= $2.0\text{A}/\mu\text{s}$)

$L=2.2\mu\text{H}$ (XFL4020-222ME)

$C_{IN}=4.7\mu\text{F}$ (GRM188R61E475K), $C_L=10\mu\text{F}$ (GRM21BR61E106K x5)

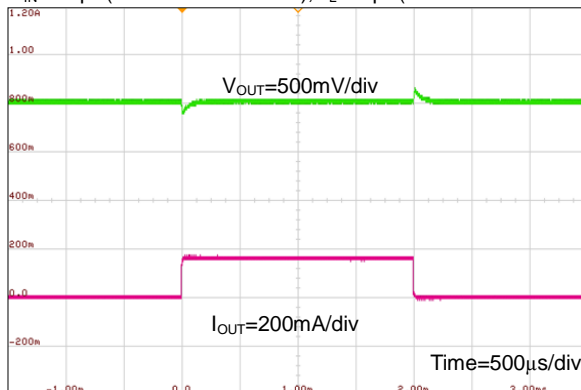

XC9144B10D(PWM/PFM, $f_{osc}=3.0\text{MHz}$), $T_a=25^\circ\text{C}$

$V_{OUTSET}=18\text{V}$, $V_{IN}=7\text{V}$, $I_{OUT}=0\text{mA}\leftrightarrow 170\text{mA}$ (Slew Rate= $2.0\text{A}/\mu\text{s}$)

$L=2.2\mu\text{H}$ (XFL4020-222ME)

$C_{IN}=4.7\mu\text{F}$ (GRM188R61E475K), $C_L=10\mu\text{F}$ (GRM21BR61E106K x5)

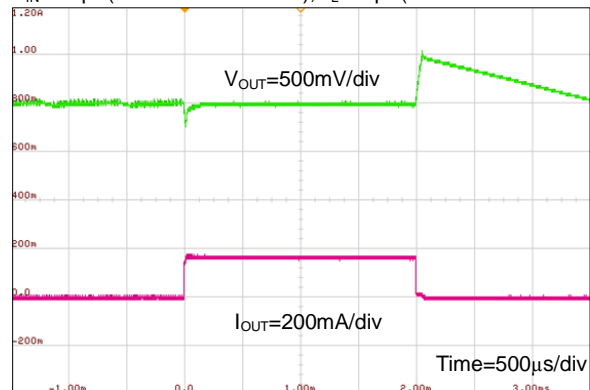

■ TYPICAL PERFORMANCE CHARACTERISTICS

(25-1) V_{OUTSET} - V_{IN} Operation Area, Max output current - V_{IN}

XC9143B10C(PWM, $f_{OSC}=1.2\text{MHz}$)

V_{OUTSET} - V_{IN} Operation Area

$T_a=-40\sim 105^\circ\text{C}$

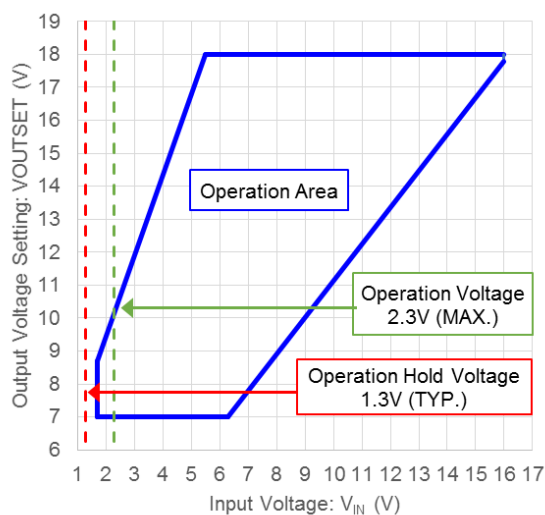

Max output current - V_{IN}

$T_a=25^\circ\text{C}$, $\theta_{ja}=100^\circ\text{C/W}$

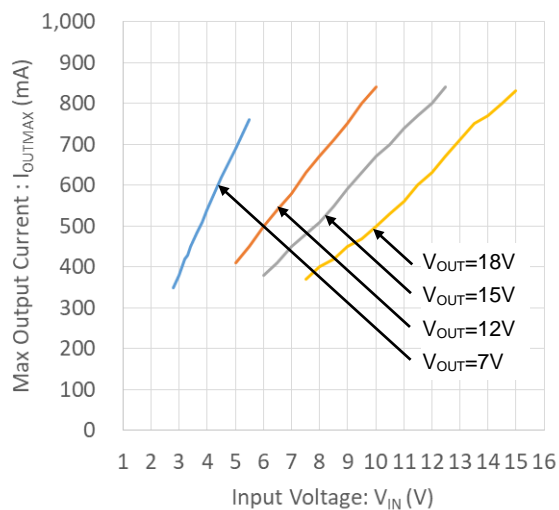

$T_a=60^\circ\text{C}$, $\theta_{ja}=100^\circ\text{C/W}$

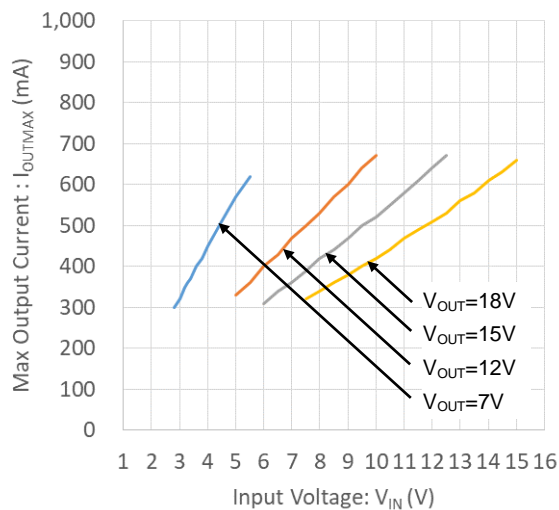

TYPICAL PERFORMANCE CHARACTERISTICS

(25-2) V_{OUTSET} - V_{IN} Operation Area, Max output current - V_{IN}

XC9144B10C(PWM/PFM, $f_{OSC}=1.2\text{MHz}$)

V_{OUTSET} - V_{IN} Operation Area

$T_a = -40\text{--}105^\circ\text{C}$

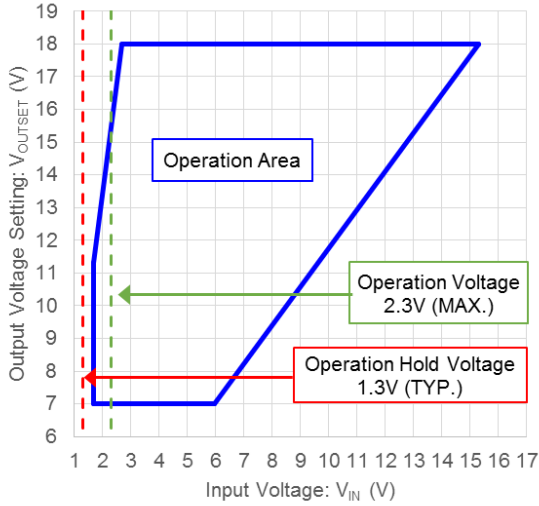

Max output current - V_{IN}

$T_a = 25^\circ\text{C}$, $\theta_{ja} = 100^\circ\text{C/W}$

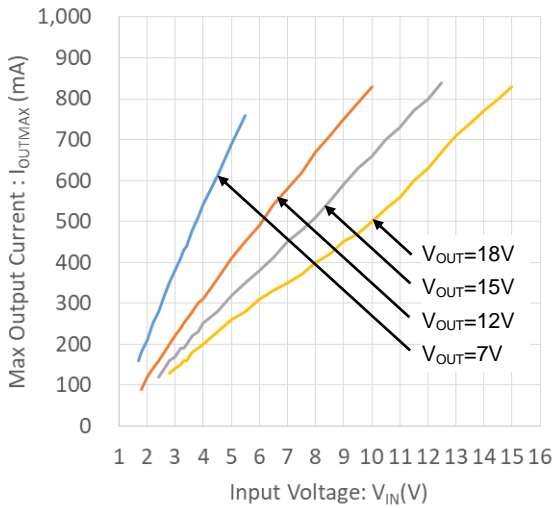

$T_a = 60^\circ\text{C}$, $\theta_{ja} = 100^\circ\text{C/W}$

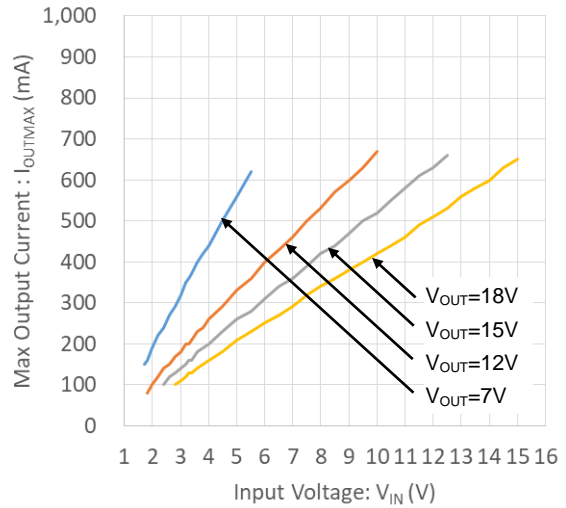

■ TYPICAL PERFORMANCE CHARACTERISTICS

(25-3) V_{OUTSET} - V_{IN} Operation Area, Max output current - V_{IN}

XC9143B10D(PWM, $f_{OSC}=3.0\text{MHz}$)

V_{OUTSET} - V_{IN} Operation Area

$T_a = -40 \sim 105^\circ\text{C}$

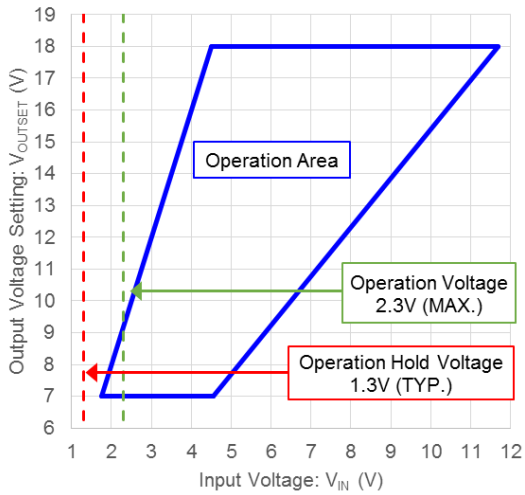

Max output current - V_{IN}

$T_a = 25^\circ\text{C}$, $\theta_{ja} = 100^\circ\text{C/W}$

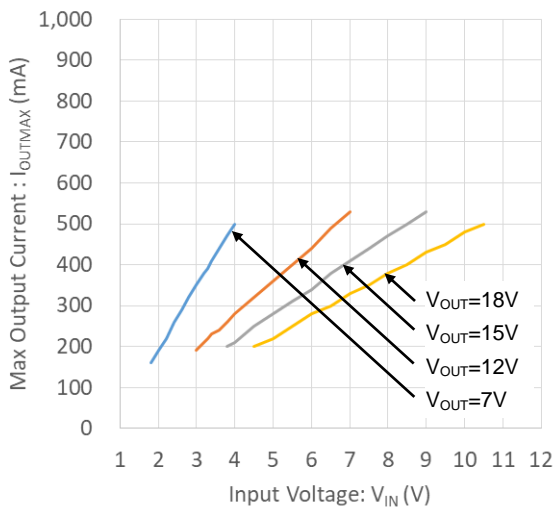

$T_a = 60^\circ\text{C}$, $\theta_{ja} = 100^\circ\text{C/W}$

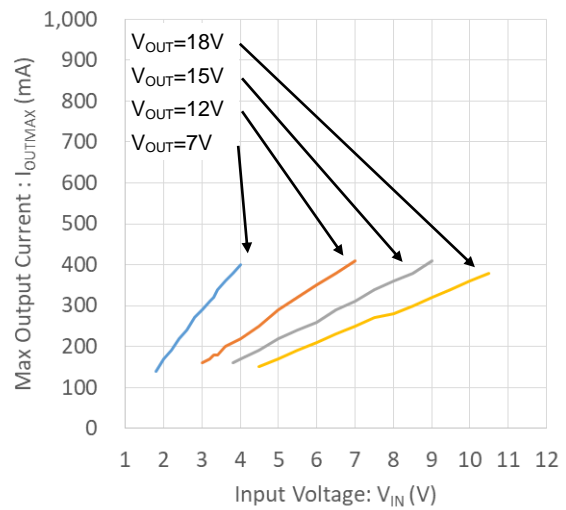

TYPICAL PERFORMANCE CHARACTERISTICS

(25-4) V_{OUTSET} - V_{IN} Operation Area, Max output current - V_{IN}

XC9144B10D(PWM/PFM, $f_{osc}=3.0\text{MHz}$)

V_{OUTSET} - V_{IN} Operation Area

$T_a = -40 \sim 105^\circ\text{C}$

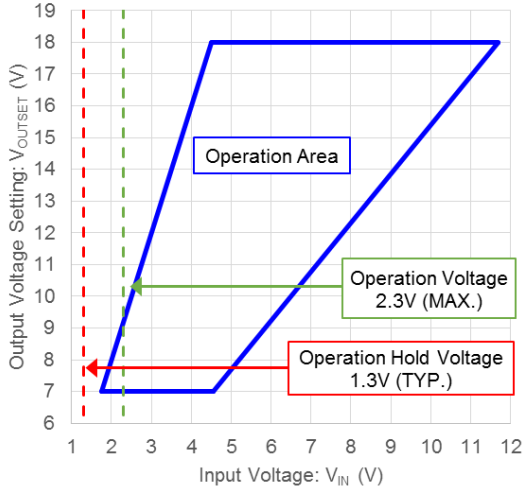

Max output current - V_{IN}

$T_a = 25^\circ\text{C}$, $\theta_{ja} = 100^\circ\text{C/W}$

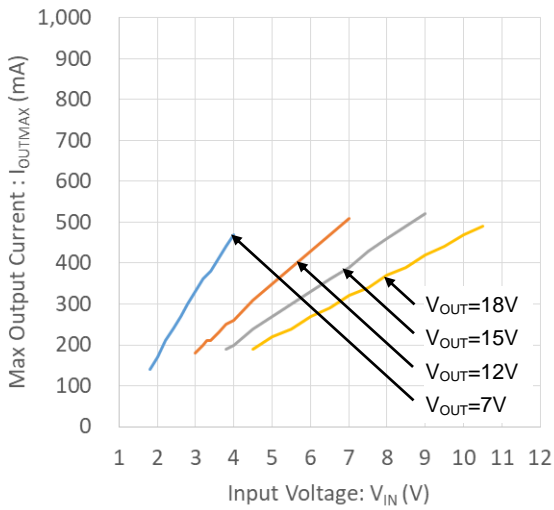

$T_a = 60^\circ\text{C}$, $\theta_{ja} = 100^\circ\text{C/W}$

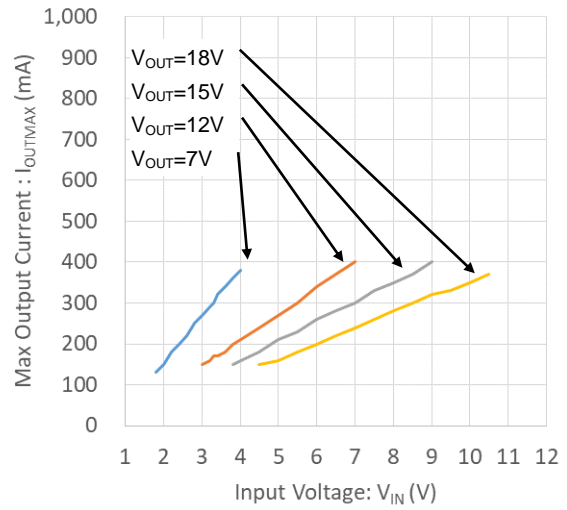

■ PACKAGING INFORMATION

For the latest package information go to, www.torexsemi.com/technical-support/packages

PACKAGE	OUTLIN / LAND PATTERN	THERMAL CHARACTERISTICS
USP-6C	USP-6C PKG	USP-6C Power Dissipation

MARKING RULE

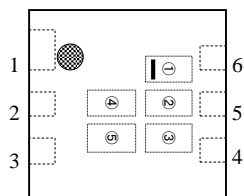

①、②represents product series

MARK		PRODUCT SERIES
①	②	
K	3	XC9143B****-G
	4	XC9144B****-G

③represents Oscillation Frequency

MARK	Oscillation Frequency	PRODUCT SERIES
C	1.2MHz	XC914*B10C**-G
D	3.0MHz	XC914*B10D**-G

④、⑤represents production lot number

01~09, 0A~0Z, 11...9Z, A1~A9, AA...Z9, ZA~ZZ in order.

(G, I, J, O, Q, W excluded)

* No character inversion used.

1. The product and product specifications contained herein are subject to change without notice to improve performance characteristics. Consult us, or our representatives before use, to confirm that the information in this datasheet is up to date.
2. The information in this datasheet is intended to illustrate the operation and characteristics of our products. We neither make warranties or representations with respect to the accuracy or completeness of the information contained in this datasheet nor grant any license to any intellectual property rights of ours or any third party concerning with the information in this datasheet.
3. Applicable export control laws and regulations should be complied and the procedures required by such laws and regulations should also be followed, when the product or any information contained in this datasheet is exported.
4. The product is neither intended nor warranted for use in equipment of systems which require extremely high levels of quality and/or reliability and/or a malfunction or failure which may cause loss of human life, bodily injury, serious property damage including but not limited to devices or equipment used in 1) nuclear facilities, 2) aerospace industry, 3) medical facilities, 4) automobile industry and other transportation industry and 5) safety devices and safety equipment to control combustions and explosions. Do not use the product for the above use unless agreed by us in writing in advance.
5. Although we make continuous efforts to improve the quality and reliability of our products; nevertheless Semiconductors are likely to fail with a certain probability. So in order to prevent personal injury and/or property damage resulting from such failure, customers are required to incorporate adequate safety measures in their designs, such as system fail safes, redundancy and fire prevention features.
6. Our products are not designed to be Radiation-resistant.
7. Please use the product listed in this datasheet within the specified ranges.
8. We assume no responsibility for damage or loss due to abnormal use.
9. All rights reserved. No part of this datasheet may be copied or reproduced unless agreed by Torex Semiconductor Ltd in writing in advance.

TOREX SEMICONDUCTOR LTD.