

## LSIC2SD170B50 1700 V, 50 A SiC Schottky Barrier Diode

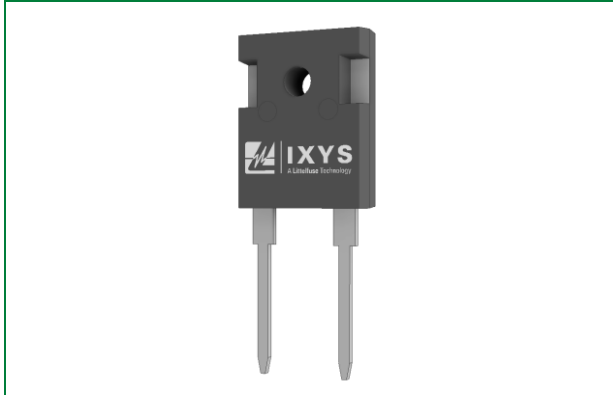

### Agency Approvals and Environmental

Environmental Approvals



### Pinout Diagram

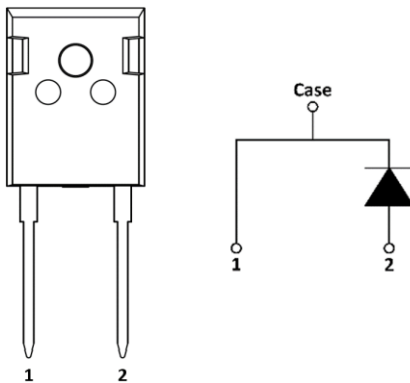

### Product Summary

Characteristic	Value	Unit
$V_{RRM}$	1700	V
$I_F (T_C \leq 135\text{ }^\circ\text{C})$	65	A
$Q_c (V_R: 0-800\text{ V})$	353	nC

### Features

- Positive temperature coefficient for safe operation and ease of paralleling
- 175 °C maximum operating junction temperature
- Excellent surge capability
- Extremely fast, temperature-independent switching behavior
- Dramatically reduced switching losses compared to Si bipolar diodes
- Zero reverse recovery current

### Applications

- Boost diodes in PFC or DC/DC stages
- Switch-mode power supplies
- Solar inverters
- Uninterruptable power supplies
- Industrial motor drives
- Battery Chargers
- High speed rectifier

1. Maximum Ratings ..... 3  
2. Thermal Characteristics ..... 3  
3. Electrical Characteristics ..... 3  
4. Performance Curves ..... 4  
5.  $V_F$  Model for Simulation ..... 5  
6. Package Dimensions ..... 6  
7. Part Numbering and Marking ..... 7  
8. Packing Options ..... 7  
9. Packing Specifications ..... 7

## 1. Maximum Ratings

Characteristic	Symbol	Conditions	Value	Unit
Repetitive Peak Reverse Voltage	$V_{RRM}$	-	1700	V
DC Blocking Voltage	$V_R$	-	1700	V
Continuous Forward Current	$I_F$	$T_C = 25\text{ }^\circ\text{C}$	135	A
		$T_C = 135\text{ }^\circ\text{C}$	65	
		$T_C = 150\text{ }^\circ\text{C}$	50	
Non-repetitive Forward Surge Current	$I_{FSM}$	$T_C = 25\text{ }^\circ\text{C}$ , $t_p = 10\text{ ms}$ , Half sine pulse	280	A
$I^2t$	$\int I^2 dt$	$T_C = 25\text{ }^\circ\text{C}$ , $t_p = 10\text{ ms}$ , Half sine pulse	390	A <sup>2</sup> s
Power Dissipation	$P_{Tot}$	$T_C = 25\text{ }^\circ\text{C}$	650	W
		$T_C = 110\text{ }^\circ\text{C}$	280	
Operating Junction Temperature	$T_J$	-	-55 to 175	$^\circ\text{C}$
Storage Temperature	$T_{STG}$	-	-55 to 150	$^\circ\text{C}$
Mounting Torque	$M_D$	M3 or 6-32 screw	0.6	Nm

## 2. Thermal Characteristics

Characteristic	Symbol	Value	Unit
Thermal Resistance	$R_{thJC, max}$	0.23	$^\circ\text{C/W}$

## 3. Electrical Characteristics

Characteristic	Symbol	Conditions	Value			Unit
			Min	Typ	Max	
Forward Voltage	$V_F$	$I_F = 50\text{ A}$ , $T_C = 25\text{ }^\circ\text{C}$	-	1.5	1.8	V
		$I_F = 50\text{ A}$ , $T_C = 175\text{ }^\circ\text{C}$	-	2.2	-	
Reverse Current	$I_R$	$V_R = 1700\text{ V}$ , $T_C = 25\text{ }^\circ\text{C}$	-	5	100	$\mu\text{A}$
		$V_R = 1700\text{ V}$ , $T_C = 175\text{ }^\circ\text{C}$	-	100	-	
Total Capacitance	C	$V_R = 1\text{ V}$ , $f = 1\text{ MHz}$	-	3900	-	pF
		$V_R = 400\text{ V}$ , $f = 1\text{ MHz}$	-	334	-	
		$V_R = 800\text{ V}$ , $f = 1\text{ MHz}$	-	240	-	
Total Capacitive Charge	$Q_C$	$V_R = 800\text{ V}$ , $Q_C = \int Q(V) dV$	-	353	-	nC
Capacitive Stored Energy	$E_C$	$V_R = 800\text{ V}$	-	77	-	$\mu\text{J}$

### 4. Performance Curves

Figure 1. Typical Forward Characteristics

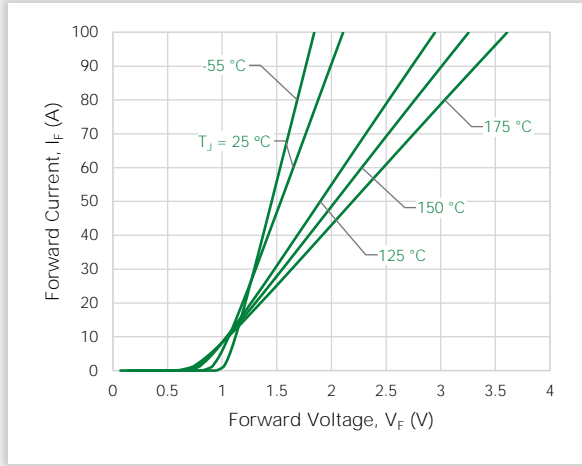

Figure 2. Typical Reverse Characteristics

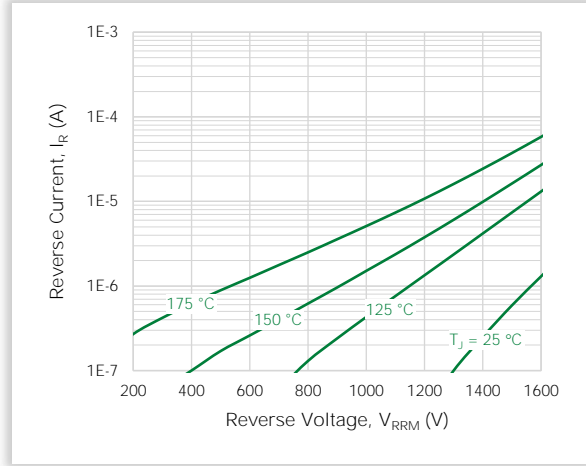

Figure 3. Power Derating

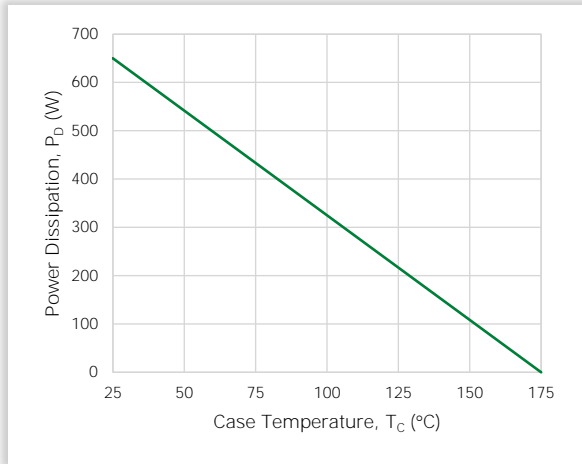

Figure 4. Current Derating

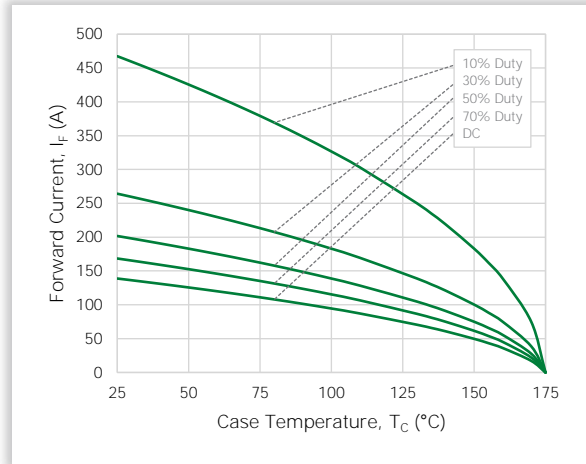

Figure 5. Capacitance vs. Reverse Voltage

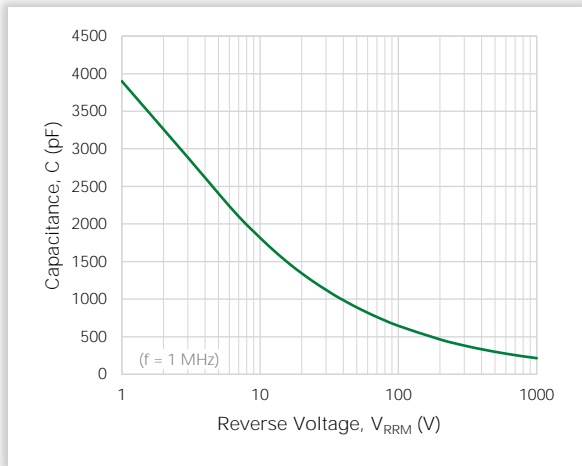

Figure 6. Capacitive Charge vs. Reverse Voltage

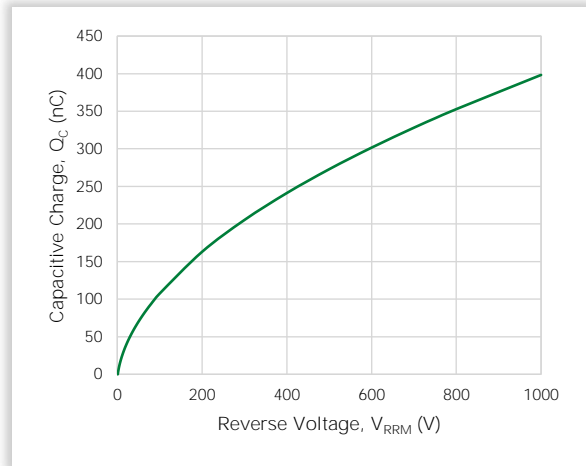

Figure 7. Stored Energy vs. Reverse Voltage

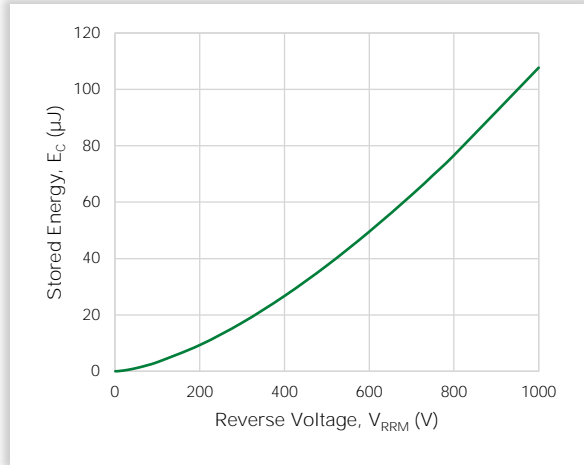
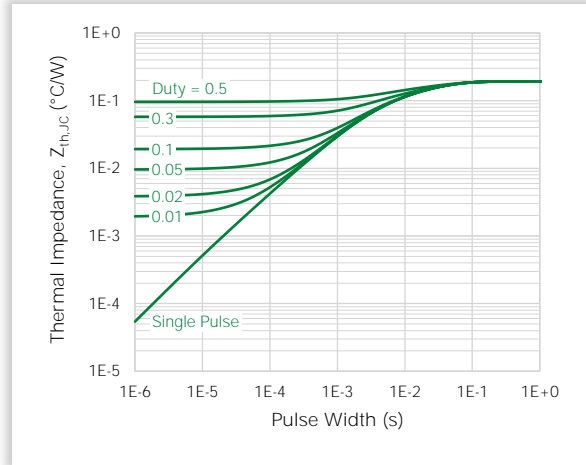
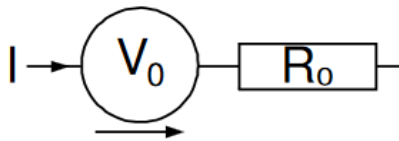

Figure 8. Transient Thermal Impedance



### 5. $V_F$ Model for Simulation



$$V_F(T_J) = V_0 + IR_0$$

$$V_0 = -1.15 \times 10^{-3} \cdot T_J + 9.90 \times 10^{-1}$$

$$R_0 = 3.25 \times 10^{-7} \cdot T_J^2 + 4.62 \times 10^{-5} \cdot T_J + 1.01 \times 10^{-2}$$

Notes:

- $T_J$  is junction temperature in  $^{\circ}$ C
- Range valid from 25  $^{\circ}$ C to 175  $^{\circ}$ C
- Model represents performance of a typical part

6. Package Dimensions

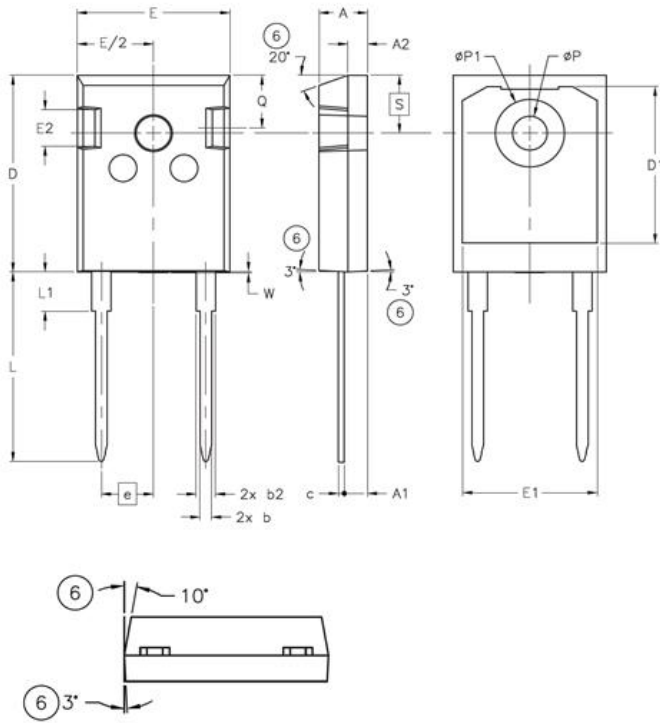

Symbol	Millimeters		
	Min	Nom	Max
A	4.7	-	5.31
A1	2.21	-	2.59
A2	1.5	-	2.49
b	0.99	-	1.4
b2	1.65	-	2.39
c	0.38	-	0.89
D	20.8	-	21.46
D1	13.08	-	-
D2	0.51	-	1.35
e	5.44 BSC		
E	15.49	-	16.26
E1	13.46	-	-
E2	3.43	-	3.99
L	19.81	-	20.32
L1	-	-	4.5
øP	3.56	-	3.66
øP1	7.06	-	7.39
Q	5.38	-	6.2
S	6.17 BSC		
W	-	-	0.15

Recommended Hole Pattern Layout:

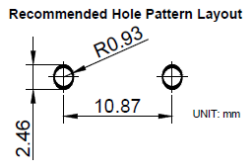

Notes:

1. Dimensions are in millimeters
2. Dimension D, E do not include mold flash. Mold flash shall not exceed 0.127 mm per side measured at outer most extreme of plastic body.
3. øP to have a maximum draft angle of 38.1 mm to the top of the part with a maximum hole diameter of 3.912 mm.

### 7. Part Numbering and Marking

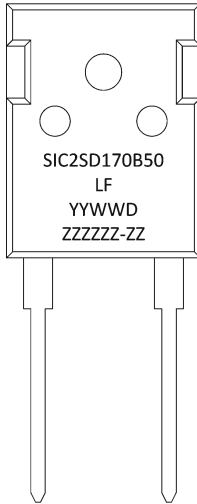

- SIC = SIC
- 2 = Gen 2
- SD = Schottky Barrier Diode
- 170 = Voltage Rating (1700 V)
- B = Package (TO-247-2L)
- 50 = Current Rating (50 A)
- YY = Year
- WW = Week
- D = Special Code
- ZZZZZZ-ZZ = Lot Number

### 8. Packing Options

Part Number	Marking	Packing Mode	M.O.Q.
LSIC2SD170B50	SIC2SD170B50	Tube (30 pcs)	30 pcs

### 9. Packing Specifications

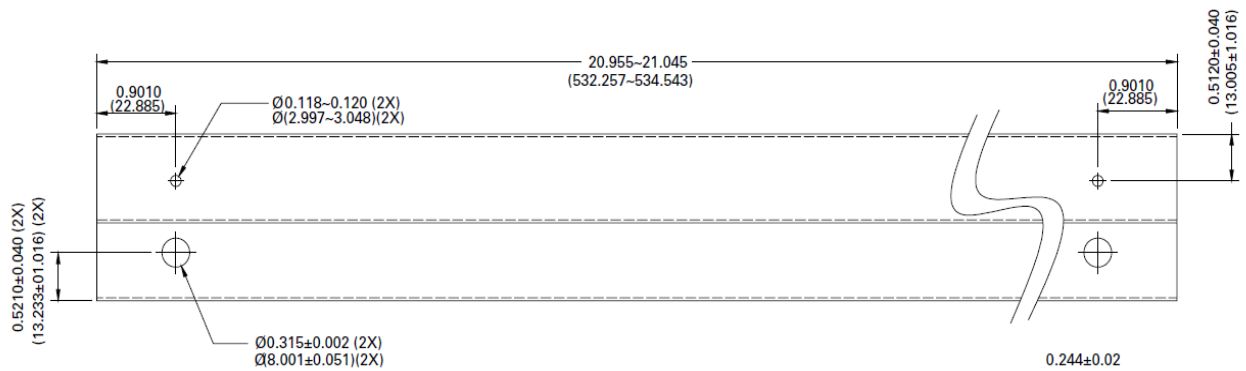

**NOTE:**

1. All pin plug holes are considered critical dimension
2. Tolerance is to be  $\pm 0.010$  unless otherwise specified
3. Dimension are in inch (and millimeters).

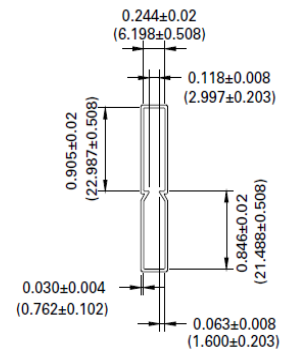

For additional information please visit [www.Littelfuse.com/powersemi](http://www.Littelfuse.com/powersemi)

Disclaimer Notice - Littelfuse products are not designed for, and shall not be used for, any purpose (including, without limitation, automotive, military, aerospace, medical, life-saving, life-sustaining or nuclear facility applications, devices intended for surgical implant into the body, or any other application in which the failure or lack of desired operation of the product may result in personal injury, death, or property damage) other than those expressly forth in applicable Littelfuse product documentation. Littelfuse shall not be liable for any claims or damages arising out of products used in applications not expressly intended by Littelfuse as set forth in applicable Littelfuse documentation.

Read complete Disclaimer Notice at [www.littelfuse.com/disclaimer-electronics](http://www.littelfuse.com/disclaimer-electronics)