

ANNA-B412

Stand-alone Bluetooth 5.1 low energy module

Data sheet

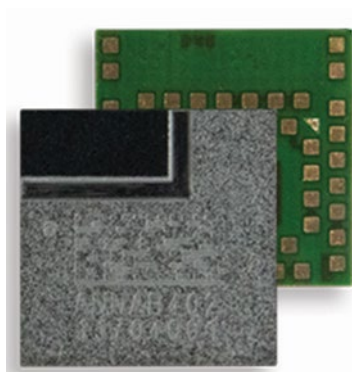

Abstract

Targeted towards hardware and software specialists, this technical data sheet includes the functional description, pin definition, specifications, country approval status, handling instructions, and ordering information for the ultra-compact ANNA-B4 stand-alone Bluetooth® 5.1 Low Energy module. Despite its small size, ANNA-B4 offers both internal and external antenna options: whereas ANNA-B402 [5] provides an open CPU architecture with a powerful MCU for customer applications, ANNA-B412 [6] is delivered with pre-flashed u-connectXpress software that supports OEMs with the shortest time-to-market. ANNA-B412 supports u-blox Bluetooth Low Energy Serial Port Service, GATT client and server, beacons, Bluetooth long range, NFC™, and simultaneous peripheral and central roles.

Document information

Title	ANNA-B412	
Subtitle	Stand-alone Bluetooth 5.1 low energy module	
Document type	Data sheet	
Document number	UBX-21028698	
Revision and date	R02	19-Oct-2021
Disclosure Restriction	C1-Public	

Product status	Corresponding content status	
Functional sample	Draft	For functional testing. Revised and supplementary data will be published later.
In development / Prototype	Objective specification	Target values. Revised and supplementary data will be published later.
Engineering sample	Advance information	Data based on early testing. Revised and supplementary data will be published later.
Initial production	Early production information	Data from product verification. Revised and supplementary data may be published later.
Mass production / End of life	Production information	Document contains the final product specification.

This document applies to the following products:

Product name	Type number	Software	Hardware version	PCN reference	Product status
ANNA-B412	ANNA-B412-00B-00	u-connectXpress	0.9	N/A	Prototype

u-blox reserves all rights to this document and the information contained herein. Products, names, logos and designs described herein may in whole or in part be subject to intellectual property rights. Reproduction, use, modification or disclosure to third parties of this document or any part thereof without the express permission of u-blox is strictly prohibited.

The information contained herein is provided "as is" and u-blox assumes no liability for the use of the information. No warranty, either express or implied, is given with respect to, including but not limited to, the accuracy, correctness, reliability and fitness for a particular purpose of the information. This document may be revised by u-blox at any time. For most recent documents, please visit www.u-blox.com.

Copyright © 2021, u-blox AG.

u-blox is a registered trademark of u-blox Holding AG in the EU and other countries.

Contents

Document information	2
Contents	3
1 Functional description	5
1.1 Overview	5
1.2 Example applications	5
1.3 Block diagram	6
1.4 Product description	7
1.5 Software architecture	7
1.6 u-connectXpress	8
1.7 Bluetooth device address	8
2 Interfaces	9
2.1 Power management	9
2.1.1 Module supply input (VCC)	9
2.1.2 Digital I/O interfaces reference voltage (VCC_IO)	9
2.2 RF antenna interfaces	9
2.2.1 2.4 GHz radio and internal antenna	9
2.2.2 Near Field Communication (NFC)	9
2.2.3 Direction Finding (AoA/AoD)	10
2.3 System functions	10
2.3.1 Module power-on	10
2.3.2 Power modes	10
2.3.3 Module power off	11
2.3.4 Module reset	11
2.4 Low Frequency Clock	11
2.5 System interfaces	12
2.5.1 GPIO	12
2.5.2 UART	12
2.5.3 u-blox Serial Port Service (SPS)	13
2.5.4 System status signals	13
2.5.5 System control signals	13
3 Pin definition	14
3.1 ANNA-B412 pin assignment	14
4 Electrical specifications	17
4.1 Absolute maximum ratings	17
4.1.1 Maximum ESD ratings	17
4.2 Operating conditions	17
4.2.1 Operating temperature range	18
4.2.2 Supply/Power pins	18
4.2.3 Current consumption	18
4.2.4 RF performance	19

4.2.5	Startup times	19
4.2.6	External 32.768 kHz crystal specifications (LFXO).....	19
4.2.7	ANNA-B412 radiation patterns	19
4.2.8	RESET_N pin.....	21
4.2.9	Digital pins.....	21
5	Mechanical specifications	22
6	Qualification and approvals	23
6.1	Country approvals.....	23
6.2	Bluetooth qualification.....	23
7	Product handling	24
7.1	Packaging	24
7.2	Reels	24
7.3	Tapes	25
7.4	Moisture sensitivity levels.....	26
7.5	Reflow soldering	26
7.6	ESD precautions.....	26
8	Labelling and ordering information	27
8.1	Product marking.....	27
8.2	Product identifiers	27
8.3	Identification codes	28
8.4	Ordering information.....	28
Appendix	29
A	Glossary	29
Related documents	30
Revision history	30
Contact	31

1 Functional description

1.1 Overview

ANNA-B412 is an ultra-compact, stand-alone Bluetooth® 5.1 Low Energy module packed into a System-in-Package (SiP) design with pre-flashed u-connectXpress software.

Based on the Nordic Semiconductor nRF52833 chip that includes an integrated 2.4 GHz transceiver with +8 dBm output power and powerful Arm® Cortex®-M4 with FPU processor, ANNA-B412 stand-alone modules support all Bluetooth 5.1 low energy modes, including long range mode and the Bluetooth 5.1 Direction Finding service.

Delivered with pre-flashed u-connectXpress software, ANNA-B412 provides support for u-blox Bluetooth Low Energy Serial Port Service, GATT client and server, Bluetooth beacons, Bluetooth long range, NFC™, and simultaneous peripheral and central roles.

Despite the small size, ANNA-B412 offers both internal and external antenna options. With the internal chip antenna option, ANNA-B412 can ease the integration of end-product. With the ANNA-B412 external antenna option, external antennas can be connected to an ANNA-B412 module through the antenna pin of the module.

Featuring Angle of Arrival (AoA) and Angle of Departure (AoD) transceivers, ANNA-B412 supports the Bluetooth 5.1 Direction Finding service. The service can be used for indoor positioning, wayfinding, asset tracking, and more. With ANNA-B412 external antenna option, the Bluetooth 5.1 Direction Finding service may also be supported using u-connectLocate software. Currently, u-connectLocate software is only available for [NINA-B41 series](#) modules. [Contact](#) your local support team for information concerning the availability of ANNA-B412 u-connectLocate software.

ANNA-B412 needs only a single supply voltage in the range of 1.7–3.6 V and, as the supply voltage level can also be used as the I/O reference level, can be easily integrated into simple, single-voltage, rail systems. The broad supply voltage range low power consumption of ANNA-B412 makes it particularly useful in battery powered systems. An additional 5 V supply is required if the USB interface is used.

With an operational temperature range that spans from -40 up to +105°C, ANNA-B412 is particularly suited for harsh applications that must operate at high ambient temperatures.

With the same physical size and mechanical design of ANNA-B112 module, ANNA-B412 offers a natural upgrade path for existing ANNA-B112 applications and extends the operating temperature from +85 degrees up to +105 degrees. ANNA-B412 has four additional pins in its footprint that increase the number of available GPIOs. See also the ANNA-B112 data sheet [7] and ANNA-B412 product summary [6].

1.2 Example applications

- Industrial automation
- Smart buildings and cities
- Low power sensors
- Wireless-connected and configurable equipment
- Point-of-sales
- Health devices
- Asset tracking
- Wearables

1.3 Block diagram

Integrating multiple functional chips in a System in Package (SiP), ANNA-B412 also includes an integrated antenna that supports two different connection options. The RF signal pin can be connected directly to the adjacent antenna pin for use with the internal antenna or otherwise routed to an external antenna or antenna connector. Figure 1 shows the antenna options and functional components of the module in a block diagram.

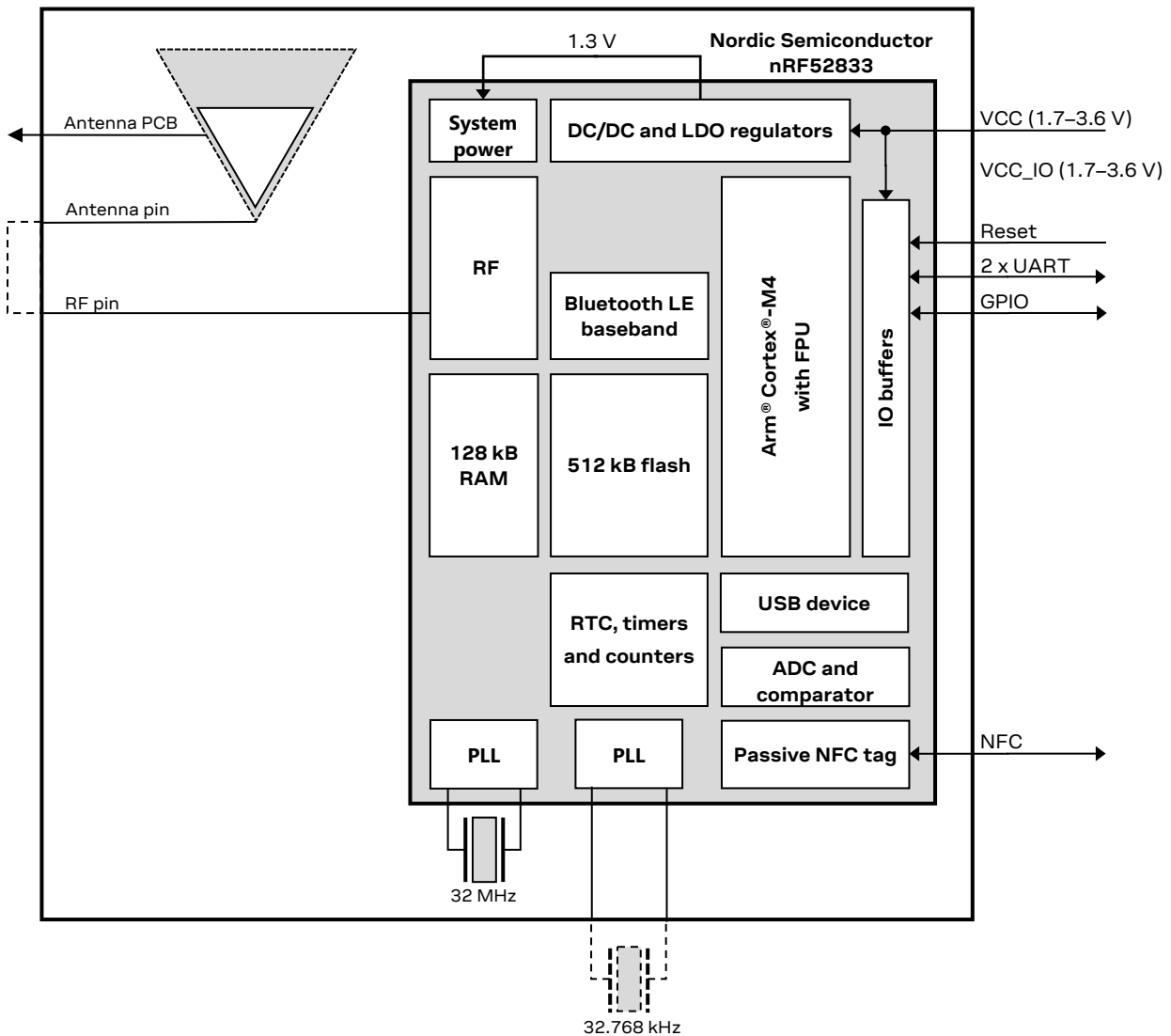

Figure 1: Block diagram of ANNA-B412

ANNA-B412 does not have its own low power oscillator (LPO), but depending on the power consumption requirement an external LPO crystal or oscillator can be connected.

An integrated DC/DC converter is used for higher efficiency under heavy load situations. See also [Module supply input \(VCC\)](#).

1.4 Product description

Item	ANNA-B412
Bluetooth version	5.1
Band support	2.4 GHz, 40 channels
Typical conducted output power	+8 dBm
Maximum radiated output power with internal antenna (EIRP)	+9 dBm
Maximum radiated output power with external antenna (EIRP)	+11 dBm
RX sensitivity, 1 Mbps (conducted)	-94 dBm
RX sensitivity, 125 kbps (conducted)	-103 dBm
Supported 2.4 GHz radio modes	Bluetooth Low Energy
Supported Bluetooth Low Energy (LE) data rates	1 Mbps 2 Mbps 500 kbps 125 kbps
Physical module size	6.5 x 6.5 x 1.2 mm

Table 1: ANNA-B412 characteristics summary

1.5 Software architecture

ANNA-B412 integrates an Arm® Cortex®-M4 application processor that includes an FPU, 512 kB flash memory, and 128 kB RAM. It is also delivered with pre-installed module software, including:

- Pre-flashed with bootloader and u-connectXpress software that interfaces through an AT command interpreter to control customer application software running on host MCUs.
- ANNA-B412 modules include the Nordic S140 SoftwareDevice Low Energy protocol stack that supports the Bluetooth Low Energy Serial Port Service, GATT server and client, central and peripheral roles, and multidrop connections.

Figure 2 shows the architecture and implementation of software components in ANNA-B412.



Figure 2: ANNA-B412 software structure

1.6 u-connectXpress

ANNA-B412 modules are pre-flashed with u-connectXpress software and delivered with the u-blox secure bootloader.

Controlled by AT commands over the UART interface, the u-connectXpress software enables use of the Bluetooth low energy functions. Supported features of the software include the u-blox low energy Serial Port Service, GATT server and client, central and peripheral roles, and multi-drop connections. ANNA-B412 modules can be configured using the s-center evaluation software [8], which can be downloaded from the [u-blox](#) website and is available free of charge.

To learn more about the features of the u-connectXpress software and the AT commands, see also the u-connectXpress software user guide [4] and u-connect AT commands manual [2].

1.7 Bluetooth device address

Each ANNA-B412 module is pre-programmed with a unique, 48-bit, Bluetooth device address. If the memory of a ANNA-B412 module is corrupted or otherwise lost, the address can be recovered from the data matrix bar code printed on the module label.

2 Interfaces

2.1 Power management

2.1.1 Module supply input (VCC)

ANNA-B412 modules use integrated step-down converters to transform the supply voltage presented at the **VCC** pin into a stable system voltage. Consequently, the modules are compatible for use in battery powered designs – without the need of an additional voltage converter.

ANNA-B412 supports two on-board converters:

- Low-dropout (LDO)
- DC/DC buck

ANNA-B412 modules automatically switch between these converters to suit the prevailing current consumption. The DC/DC converter is more efficient under high loads when the radio is active, while the LDO converter is better suited for power saving modes.

2.1.2 Digital I/O interfaces reference voltage (VCC_IO)

ANNA-B412 generally provides an additional voltage supply input for setting the I/O voltage level. The I/O voltage level is similar to the supply voltage and **VCC_IO** is internally connected to the supply input. Therefore, only a single supply voltage is needed for ANNA-B412, which makes it ideal for battery powered designs.

2.2 RF antenna interfaces

2.2.1 2.4 GHz radio and internal antenna

ANNA-B412 offers both internal and external antenna options:

- With the internal chip antenna option, the **ANT** pin can be connected to the feeding point of the internal antenna through the **ANT_INT** pin. The **ANT_PCB** pin or the **ANT_GND1** and **ANT_GND2** pins can also be connected to an external antenna strip.
- With an external antenna option, the external antenna or antenna connector can be connected to **ANT** pin through a controlled impedance trace.

The RF pin (**ANT**) in ANNA-B412 is connected to the single-ended Tx/Rx antenna connection of the 2.4 GHz radio transceiver in nRF52833 chip. The nRF52833 chip has an integrated balun but does require the external filter/matching circuitry integrated in the the module. The RF pin (**ANT**) of the module is matched to 50 Ω .

For information about the antenna reference designs and corresponding integration instructions, see also the ANNA-B4 system integration manual [3].

2.2.2 Near Field Communication (NFC)

ANNA-B412 includes a Near Field Communication interface that can operate as a 13.56 MHz NFC tag at a bit rate of 106 kbps.

As an NFC tag, data can be read from or written to ANNA-B412 using an NFC reader. ANNA-B412 modules are not capable of reading other tags or initiating NFC communications.

The NFC interface can be used to wake the module from sleep mode, which means that the module can be kept in the deepest power save mode and still wake up properly to react to an NFC field.

Two pins are available for connecting to an external NFC antenna: **NFC1** and **NFC2**.

2.2.3 Direction Finding (AoA/AoD)

ANNA-B412 modules support a location Bluetooth 5.1 service called Bluetooth Direction Finding. The service is based on two solution architectures: Angle of Arrival (AoA) and Angle of Departure (AoD). This service can be used for indoor positioning, wayfinding, and asset tracking.

This phase-based location service requires antenna arrays, estimation algorithms, and processing power to triangulate and detect the direction of a Bluetooth signal. The AoA receiver and AoD transmitter use antenna arrays, where individual antennas in the array are switched on one by one. This switching sequence allows the direction of a peer device to be calculated. The derived IQ samples are used to determine the relative path lengths between the antenna pairs and subsequent location of the transmitter.

With the ANNA-B412 external antenna option, the Bluetooth 5.1 Direction Finding service may also be supported using u-connectLocate software. Currently, u-connectLocate software is only available for [NINA-B41 series](#) modules. [Contact](#) your local support team for information concerning the availability of ANNA-B412 u-connectLocate software.

2.3 System functions

ANNA-B412 modules are power-efficient devices that can operate in different power saving modes and configurations. The various functional parts of ANNA-B412 can be powered off when they are not needed, and complex wake-up events can be generated from different external and internal inputs.

2.3.1 Module power-on

ANNA-B412 modules can be switched on or rebooted in one of the following ways:

- Supply a valid supply voltage to the **VCC** pin
- Issuing a reset of the module. See also [Module reset](#).
- Rising voltage level on **UART_DSR** pin
- Supplying 5 V to the **VBUS** pin (plugging in the USB interface)

2.3.2 Power modes

For optimizing power consumption, ANNA-B412 supports several different power modes:

- ACTIVE mode
- STANDBY mode
- SLEEP mode

Depending on the application, the module spends most of its time in either standby or sleep mode to minimize current consumption. The radio part of the module operates independently from the CPU.

2.3.2.1 ACTIVE mode

ANNA-B12 is in ACTIVE mode when it is transmitting or receiving at high speed and the CPU is running at full speed. When the module stops transmitting, ANNA-B12 automatically leaves ACTIVE mode and enters STANDBY mode .

When waking up from standby mode to active mode, an event can also be triggered by:

- The on-board Real Time Counter (RTC)
- The radio interface
- Detection of an NFC field

2.3.2.2 STANDBY mode

Standby mode is one of the power saving modes that powers down the module but keeps the system RAM and configuration intact. It also allows for complex, autonomous, power-up events, including periodic RTC events and radio events.

The following events can be used to bring the module out of standby mode:

- Internal wake-up events from the RTC, radio, NFC, and so on.
- Analog or digital sensor events (programmable voltage level or edge detection)

The module is clocked at 32.768 kHz in standby mode. The clock is generated by an internal RC-oscillator.

2.3.2.3 SLEEP mode

Sleep mode is the deepest power-saving mode. During sleep mode, all functionality is stopped to ensure minimum power consumption. The module needs an external event to wake up from sleep mode. The module always reboots after waking up from sleep mode.

When using the u-connectXpress software, the module can be manually switched on or off with proper storage of current settings using the UART **DSR** pin.

2.3.3 Module power off

There is no dedicated pin to power off ANNA-B412 modules. You can configure the UART **DSR** pin to enter or exit the sleep mode, which essentially powers down the module. See also [Module reset](#).

An under-voltage (brown-out) shutdown occurs when the VCC supply of the module drops below the minimum limit of the operating range. In these instances, it is not possible to store the current parameter settings in the non-volatile memory of the module.

2.3.4 Module reset

ANNA-B412 modules can be reset in one of the following ways:

- Applying a low logic level on the **RESET_N** pin, which is normally pulled high using an internal pull-up resistor. This causes an “external” or “hardware” reset of the module. The prevailing parameter settings are not saved in the non-volatile module memory and a proper network detach is not performed.
- Using the `AT+CPWROFF` command to initiate an “internal” or “software” reset of the module. The current parameter settings are saved in the non-volatile module memory and a proper network detach is performed.

2.4 Low Frequency Clock

ANNA-B412 modules require two clocks: one high frequency clock and one low frequency clock:

- The high frequency clock is provided on-module by a high-accuracy 32 MHz crystal as required by the radio operation.
- The low frequency clock can be provided internally by the RC oscillator of nRF52833 or externally by a 32.768 kHz crystal. Using the internal RC oscillator with calibration can provide acceptable performance for Bluetooth low energy applications with reduced cost and slight increase in power consumption.
- An external 32.768 kHz crystal can provide the lowest power consumption with greatest accuracy.

For further information about the LFXO operating parameters and performance of the clock, see also [External 32.768 kHz crystal specifications \(LFXO\)](#).

 When using an external crystal with ANNA-B412 at operating temperatures above 85 °C, certain limitations apply. For further information, see also the Nordic nRF52833 specification for [extended operating temperature](#). For Normal operating temperature range LFXO debounce time is 0.25s. For extended temperature range LFXO debounce time is 0.50 s.

2.5 System interfaces

This section describes the ANNA-B412 system interfaces. See also the u-connectXpress AT commands manual [2] and u-connectXpress software user guide [4].

2.5.1 GPIO

ANNA-B412 modules have a versatile pin-out. In an un-configured state, ANNA-B412 supports a total of 19 GPIO pins with no analog interfaces. All interfaces or functions must be allocated to a GPIO pin before use.

2.5.2 UART

ANNA-B412 supports two UART interfaces: one primary and one secondary interface.

The 4-wire UART interfaces support hardware flow control and baud rates up to 1 Mbps. Other characteristics of the UART interface include:

- Default baud rate is 115200 and frame configuration is 8N1, meaning eight (8) data bits, no (N) parity bit, and one (1) stop bit.
- Frames are transmitted in such a way that the least significant bit (LSB) is transmitted first.
- Pin configuration:
 - **TXD**, data output pin
 - **RXD**, data input pin
 - **RTS**, Request To Send, flow control output pin (optional)
 - **CTS**, Clear To Send, flow control input pin (optional)
- Hardware flow control or no flow control is supported.
- Power saving indication available on the hardware flow control output (**RTS** pin): The line is driven to the OFF state when the module is not ready to accept data signals.
- Programmable baud rate generator that supports most industry standard rates, as well as non-standard rates up to 1 Mbps.

For more information about how the interfaces are controlled using AT commands, see also the u-connectXpress AT commands manual [2] and u-connectXpress software user guide [4].

2.5.2.1 Primary UART

The primary UART interface is used for communicating with ANNA-B412 modules from a host controller. It can be used for configuring the modules and transferring data to or from a Bluetooth LE link or any connected sensor. The interface has a fixed pin configuration that may not be changed.

In addition to the **RXD**, **TXD**, **CTS**, and **RTS** signals, the u-connectXpress software configures **DSR** and **DTR** signals to the UART interface. Note that these signals are not used as originally intended but are used to control the state of the ANNA-B412 module.

The **DSR** signal can be used to:

- Enter the command mode
- Disconnect and/or toggle connectable status
- Enable/disable the rest of the UART interface
- Enter/wake up from the sleep mode

The **DTR** signal can be used to indicate:

- System mode (data or command mode)
- If an SPS peer is connected
- If a bonded peer is connected
- If there is an active Bluetooth LE GAP connection

2.5.2.2 Secondary UART

The secondary UART interface can be used to "daisy chain" UART connections. It is useful in resource constrained systems, where the host controller only has one UART interface available. To use it, ANNA-B412 is configured to become a UART bridge, and UART data sent over the primary UART interface flows into the secondary UART interface.

The secondary UART interface pins can be freely configured to any free GPIO pins. It uses four signals: **RXD**, **TXD**, **CTS** and **RTS**.

2.5.3 u-blox Serial Port Service (SPS)

The serial port service feature enables serial port emulation over Bluetooth LE.

2.5.4 System status signals

The RED, GREEN, and BLUE pins are used to signal the system status, as shown in Table 2. The pins are active low and are normally routed to an RGB LED.

Mode	Status	RGB LED color	RED	GREEN	BLUE
Data mode/Extended Data mode (EDM)	IDLE	Green	HIGH	LOW	HIGH
Command mode	IDLE	Orange	LOW	LOW	HIGH
EDM/Data mode, Command mode	CONNECTING	Purple	LOW	HIGH	LOW
EDM/Data mode Command mode	CONNECTED*	Blue	HIGH	HIGH	LOW

Table 2: System status indication

*= LED flashed on data activity

 CONNECTING and CONNECTED reflect the u-blox SPS connection status.

2.5.5 System control signals

The following input signals are used to control the system:

- **RESET_N** is used to reset the system. See also [Module reset](#).
- If **SWITCH_2** is driven low during start up, the UART serial settings are restored to their default values.
- **SWITCH_2** can be used to open a Bluetooth LE connection with a peripheral device.
- If both **SWITCH_1** and **SWITCH_2** are driven low during startup, the system enters bootloader mode.
- If both **SWITCH_1** and **SWITCH_2** are driven low during start up and held low for 10 seconds, the system exits the bootloader mode and restores all settings to their factory default.

3 Pin definition

3.1 ANNA-B412 pin assignment

Figure 3 shows the pinout and pin configuration of ANNA-B412:

- Follow this pin layout when using the u-connectXpress software. No interfaces can be moved or added.
- Do not apply an NFC field to the NFC pins when they are configured as GPIOs as this can cause permanent damage to the module. When using the u-connectXpress software, the NFC pins are always set to the NFC mode. See also [Digital Pins](#).
- The grey pins shown in Figure 3 are **GND** pins.

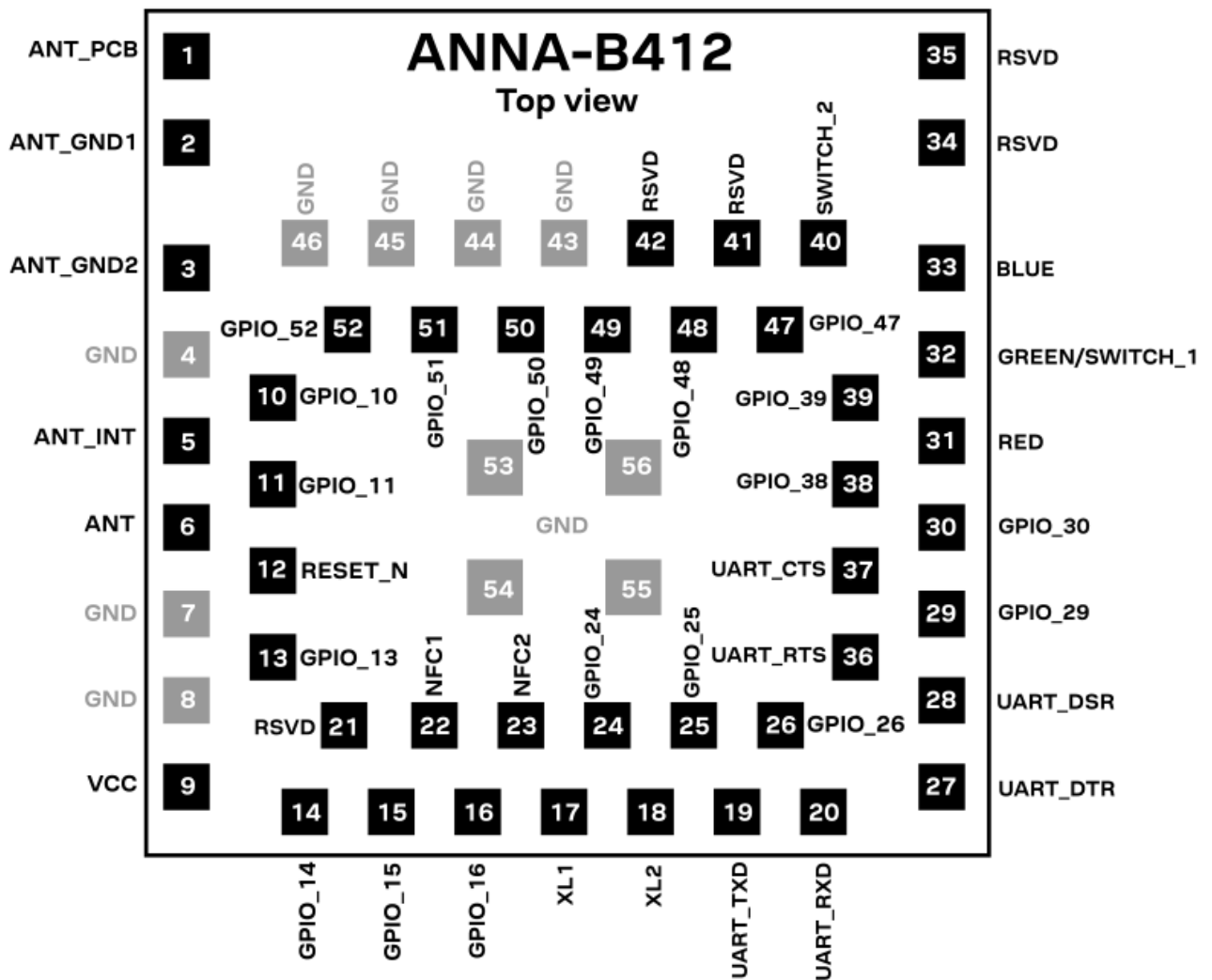



Figure 3: ANNA-B412 pin assignment (top view)

No.	Name	I/O	Description	Remarks
1	ANT_PCB	I/O	Antenna pattern on carrier board if the module is mounted in a corner.	Should only be connected if the module is mounted at a corner of a carrier PCB. See also 2.4 GHz radio and internal antenna .
2	ANT_GND1	-	Antenna ground pattern if the module is mounted in the middle of a side.	Should only be connected if the module is mounted on the edge of a carrier PCB. See also 2.4 GHz radio and internal antenna .
3	ANT_GND2	-	Antenna grounding if the module is mounted in the middle of a side.	Should only be connected if the module is mounted on the edge of a carrier PCB. See also 2.4 GHz radio and internal antenna .
4	GND	-	Ground	
5	ANT_INT	I/O	Feeding to internal antenna of the module.	Connect to ANT pin if the internal antenna is used. See also 2.4 GHz radio and internal antenna .
6	ANT	I/O	Tx/Rx antenna interface.	50 Ω nominal characteristic impedance. Connect to ANT pin if the internal antenna is used. See also 2.4 GHz radio and internal antenna .
7-8	GND	-	Ground	
9	VCC	I	Module supply voltage input	1.7-3.6 V range.
10	GPIO_10	I/O	uX IO pin	Can be used for manual digital I/O
11	GPIO_11	I/O	uX IO pin	Can be used for manual digital I/O
12	RESET_N	I	System reset input	Active low
13	GPIO_13	I/O	uX IO pin	Can be used for manual digital I/O
14	GPIO_14	I/O	uX IO pin	Can be used for manual digital I/O
15	GPIO_15	I/O	uX IO pin	Can be used for manual digital I/O
16	GPIO_16	I/O	uX IO pin	Can be used for manual digital I/O
17	XL1	I/O	u-connextXpress (uX) IO pin Connection for 32.768 kHz crystal	If not used ground XL1 and XL2.
18	XL2	I/O	u-connextXpress (uX) IO pin Connection for 32.768 kHz crystal	If an external clock source is used instead of a crystal: - Apply external low swing signal to XL1 and ground XL2. - Apply external full swing signal to XL1 and leave XL2 grounded.
19	UART_TXD	O	UART data output	Also used by the bootloader
20	UART_RXD	I	UART data input	Also used by the bootloader
21	RSVD	-	RESERVED pin	Leave unconnected
22	NFC1	I/O	NFC pin 1	
23	NFC2	I/O	NFC pin 2	
24	GPIO_24	I/O	uX IO pin	Can be used for manual digital I/O
25	GPIO_25	I/O	uX IO pin	Can be used for manual digital I/O
26	GPIO_26	I/O	uX IO pin	Can be used for manual digital I/O
27	UART_DTR	O	UART data terminal ready signal	Used to indicate system status
28	UART_DSR	I	UART data set ready signal	Used to change the system modes
29	GPIO_29	I/O	uX IO pin	Can be used for manual digital I/O
30	GPIO_30	I/O	uX IO pin	Can be used for manual digital I/O
31	RED	O	RED system status signal	Active low, should be routed to an RGB LED
32	GREEN/SWITC H_1	I/O	This signal is multiplexed: GREEN - System status signal. SWITCH_1 - Multiple functions	Active low. GREEN: Should be routed to an RGB LED. SWITCH_1: See also System control signals .
33	BLUE	O	BLUE system status signal	Active low, should be routed to an RGB LED
34	RSVD	-	RESERVED pin	Leave unconnected
35	RSVD	-	RESERVED pin	Leave unconnected
36	UART_RTS	O	UART request to send control signal	Used only when hardware flow control is enabled

No.	Name	I/O	Description	Remarks
37	UART_CTS	I	UART clear to send control signal	Used only when hardware flow control is enabled
38	GPIO_38	I/O	uX IO pin	Can be used for manual digital I/O
39	GPIO_39	I/O	uX IO pin	Can be used for manual digital I/O
40	SWITCH_2	I/O	Multiple functions	Active low. See also System control signals .
41	RSVD	-	RESERVED pin	Leave unconnected
42	RSVD	-	RESERVED pin	Leave unconnected
43-46	GND	-	Ground	
47	GPIO_47	I/O	uX IO pin	Can be used for manual digital I/O
48	GPIO_48	I/O	uX IO pin	Can be used for manual digital I/O
49	GPIO_49	I/O	uX IO pin	Can be used for manual digital I/O
50	GPIO_50	I/O	uX IO pin	Can be used for manual digital I/O
51	GPIO_51	I/O	uX IO pin	Can be used for manual digital I/O
52	GPIO_52	I/O	uX IO pin	Can be used for manual digital I/O
53-56	GND	-	Ground	The exposed pins in the center of the module should be connected to GND

Table 3: ANNA-B412 with u-connectXpress software pinout

4 Electrical specifications

-  Stressing the device above one or more of the ratings listed in the [Absolute maximum rating](#) section may cause permanent damage. These are stress ratings only. Operating the module at these or at any conditions other than those specified in the [Operating conditions](#) should be avoided. Exposure to absolute maximum rating conditions for extended periods may affect device reliability.
-  Operating condition ranges define those limits within which the functionality of the device is guaranteed. Where application information is given, it is advisory only and does not form part of the specification.

4.1 Absolute maximum ratings

Symbol	Description	Condition	Min	Max	Unit
VCC	Module supply voltage	Input DC voltage at VCC pin	-0.3	3.9	V
V_DIO	Digital pin voltage	Input DC voltage at any digital I/O pin, VCC ≤ 3.6 V	-0.3	VCC + 0.3	V
		Input DC voltage at any digital I/O pin, VCC > 3.6 V	-0.3	3.9	V
P_ANT	Maximum power at receiver	Input RF power at antenna pin		+10	dBm

Table 4: Absolute maximum ratings

-  The product is not protected against overvoltage or reversed voltages. The voltage spikes exceeding the power supply voltage specification, provided in Table 4, must be limited to the values within the specified boundaries using appropriate protection devices.

4.1.1 Maximum ESD ratings

Parameter	Min	Typical	Max	Unit	Remarks
ESD sensitivity for all pins except ANT pin			2**	kV	Human body model class 2 according to JEDEC JS001
			500**	V	Charged device model according to JESD22-C101
ESD indirect contact discharge			±8*	kV	According to EN 301 489-1



*Tested on ANNA-B4 evaluation board.

**Target values only - module qualification ongoing

Table 5: Maximum ESD ratings

-  ANNA-B412 modules are Electrostatic Sensitive Devices and require special precautions while handling. See also section [ESD precautions](#) for ESD handling instructions.

4.2 Operating conditions

-  Unless otherwise specified, all given operating condition specifications are taken for an ambient temperature of 25 °C with a supply voltage of 3.3 V.
-  Operation beyond the specified operating conditions is not recommended. Any extended exposure outside of these specific limits can affect device reliability.
-  The RAM Data retention endurance is 10,000 write/erase cycles (10 years) throughout the temperature range up to 85 °C. RAM Data retention is limited to 1000 write/erase cycles (3 years) at extended temperature range of 105 °C.

4.2.1 Operating temperature range

Parameter	Min	Max	Unit
Storage temperature	-40	+105	°C
Operating temperature	-40	+105	°C

Table 6: Temperature range

4.2.2 Supply/Power pins

Symbol	Parameter	Min	Typ	Max	Unit
VCC	Input supply voltage	1.7	3.3	3.6	V
t_RVCC	Supply voltage rise time			60	ms
VCC_ripple	VCC input noise peak to peak, 10 - 100 KHz			TBD	mV
	VCC input noise peak to peak, 100 KHz - 1 MHz			TBD	mV
	VCC input noise peak to peak, 1 - 3 MHz			TBD	mV
VCC_IO	I/O reference voltage		VCC		V

Table 7: Input characteristics of voltage supply pins

4.2.3 Current consumption

Table 8 shows the current consumption of ANNA-B412 during some typical use cases when using the u-connectXpress software.

Condition		3.3 V VCC		1.8 V VCC	
Mode	Condition	Average	Peak	Average	Peak
Active	Advertising (u-blox Serial Service, Apple iBeacon, etc.) at 1 s intervals with +8 dBm output power and 31 bytes payload, and CPU and UART interface running.				
	1 Mbit/s PHY	0.80 mA	20 mA	0.87 mA	34 mA
	CODED PHY	0.90 mA	20 mA	1.04 mA	34 mA
Standby	Advertising (u-blox Serial Service, Apple iBeacon etc.) at 1 s intervals with +8 dBm output power and 31 bytes payload				
	1 Mbit/s PHY	35 µA	20 mA	50 µA	34 mA
	CODED PHY	140 µA	20 mA	226 µA	34 mA
Active	Connected as peripheral, 50 ms connection interval, +8 dBm output power, no data throughput, CPU and UART interface is running				
	1 Mbits/s PHY	0.88 mA	20 mA	0.97 mA	35 mA
	2 Mbits/s PHY	0.86 mA	20 mA	0.95 mA	35 mA
	CODED PHY	1.15 mA	20 mA	1.40 mA	35 mA
Standby	Connected as peripheral, 50 ms connection interval, +8 dBm output power, no data throughput				
	1 Mbits/s PHY	128 µA	18 mA	163 µA	32 mA
	2 Mbits/s PHY	112 µA	18 mA	138 µA	32 mA
	CODED PHY	408 µA	18 mA	614 µA	32 mA
Sleep	UART DSR pin is used to enter the sleep mode. No RAM retention.	400 nA	-	350 nA	-

Table 8: Current consumption during typical use cases

The standby mode advertising and connected use cases described in Table 8 list the average current consumption of an ANNA-B412 module when using the typical configuration of a 1 s Bluetooth advertising interval and a 50 ms connection interval.

Make sure that the configured output power of your application product does not exceed the maximum allowed limits for your intended target market(s). For more information about your local limits, see also the ANNA-B4 system integration manual [3] for regulatory information application note.

4.2.4 RF performance

Parameter	Test condition	Min	Typ	Max	Unit
Receiver input sensitivity	Conducted at 25 °C, 1 Mbit/s Bluetooth LE mode		-94		dBm
	Conducted at 25 °C, 2 Mbit/s Bluetooth LE mode		-91		dBm
	Conducted at 25 °C, 500 kbit/s Bluetooth LE mode		-97		dBm
	Conducted at 25 °C, 125 kbit/s Bluetooth LE mode		-103		dBm
Maximum output power	Conducted at 25 °C		+8		dBm
ANNA-B412 internal antenna gain	Mounted on an EVB-ANNA-B4		+1.0		dBi

Table 9: RF performance

4.2.5 Startup times

Parameter	Time	Unit
Hardware reset (toggling the RESET_N pin of module)	1.37	s
Software reset (reboot using AT command)	1.26	s

Table 10: Startup times

4.2.6 External 32.768 kHz crystal specifications (LFXO)

Symbol	Parameter	Typ.	Max.	Unit
F_{NOM_LFXO}	Crystal frequency	32.768	-	kHz
$F_{TOL_LFXO_BLE}$	Frequency tolerance, Bluetooth low energy applications ¹	-	±500	ppm
$f_{TOL_LFXO_ANT}$	Frequency Tolerance, ANT applications ²	-	±50	ppm
C_{L_LFXO}	Load Capacitance	-	12.5	pF
C_{O_LFXO}	Shunt Capacitance	-	2	pF
R_{S_LFXO}	Equivalent series resistance	-	100	kΩ
C_{pin}	Input Capacitance on XL1 & XL2 pads	5	-	pF

Table 11: 32.768 kHz crystal (LFXO)

4.2.7 ANNA-B412 radiation patterns

Table 12 describes the radiation patterns for ANNA-B412 before radio tuning/optimization. The given data is based on preliminary test results. The antenna radiation test setup utilizes the reference design that comprises an evaluation board with ANNA-B412 situated in the corner of the EVK-ANNA-B412 board. For more information, see also the ANNA-B4 system integration manual [3].

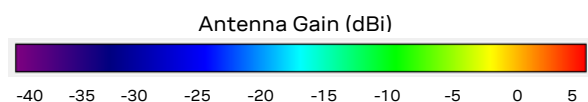

¹ $f_{TOL_LFXO_BLE}$ and $f_{TOL_LFXO_ANT}$ are the maximum allowed for Bluetooth low energy and ANT applications. Actual tolerance depends on the crystal used.

² The ANT protocol requires the use of an external crystal.

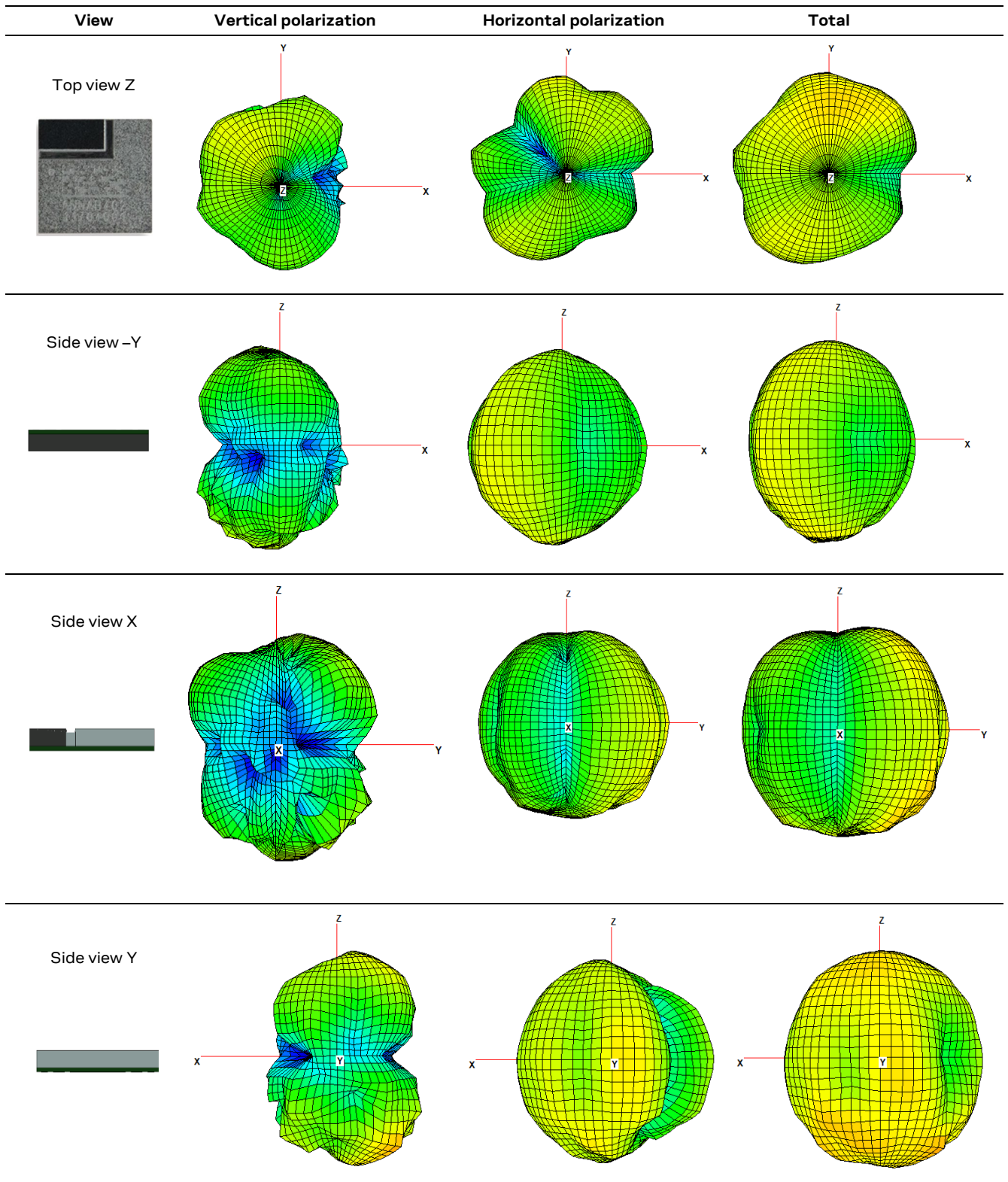

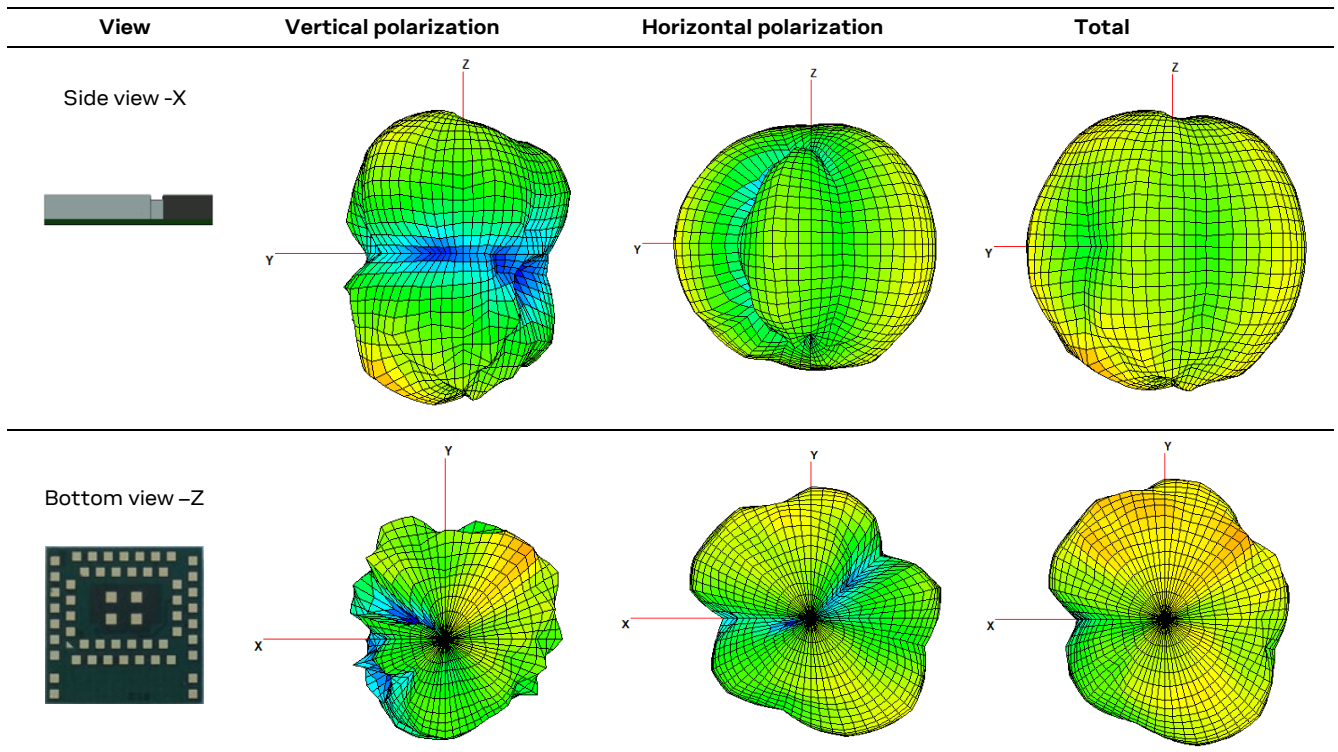

Table 12: Antenna radiation patterns

4.2.8 RESET_N pin

Pin name	Parameter	Min	Typ	Max	Unit	Remarks
RESET_N	Low-level input	0		0.3*VCC	V	
	Internal pull-up resistance		13		kΩ	
	RESET duration			55	ms	Time taken to release a pin reset.

Table 13: RESET_N pin characteristics

4.2.9 Digital pins

Pin name	Parameter	Min	Typ	Max	Unit	Remarks
Any digital pin	Input characteristic: Low-level input	0		0.3*VCC	V	
	Input characteristic: high-level input	0.7*VCC		VCC	V	
	Output characteristic: Low-level output	0		0.4	V	Standard drive strength
	Output characteristic: High-level output	VCC-0.4		VCC	V	Standard drive strength
	Sink/Source current	1	2	4	mA	Standard drive strength
	Rise/Fall time		9 – 25		ns	Standard drive strength, depending on load capacitance
	Input pull-up resistance	11	13	16	kΩ	Can be added to any GPIO pin configured as input
	Input pull-down resistance	11	13	16	kΩ	Can be added to any GPIO pin configured as input
GPIO_22, GPIO_23	Leakage current		1	10	μA	When not configured for NFC and driven to different logic levels

Table 14: Digital pin characteristics

5 Mechanical specifications

Figure 4 shows the mechanical outline and critical dimensions of the ANNA-B412 package.

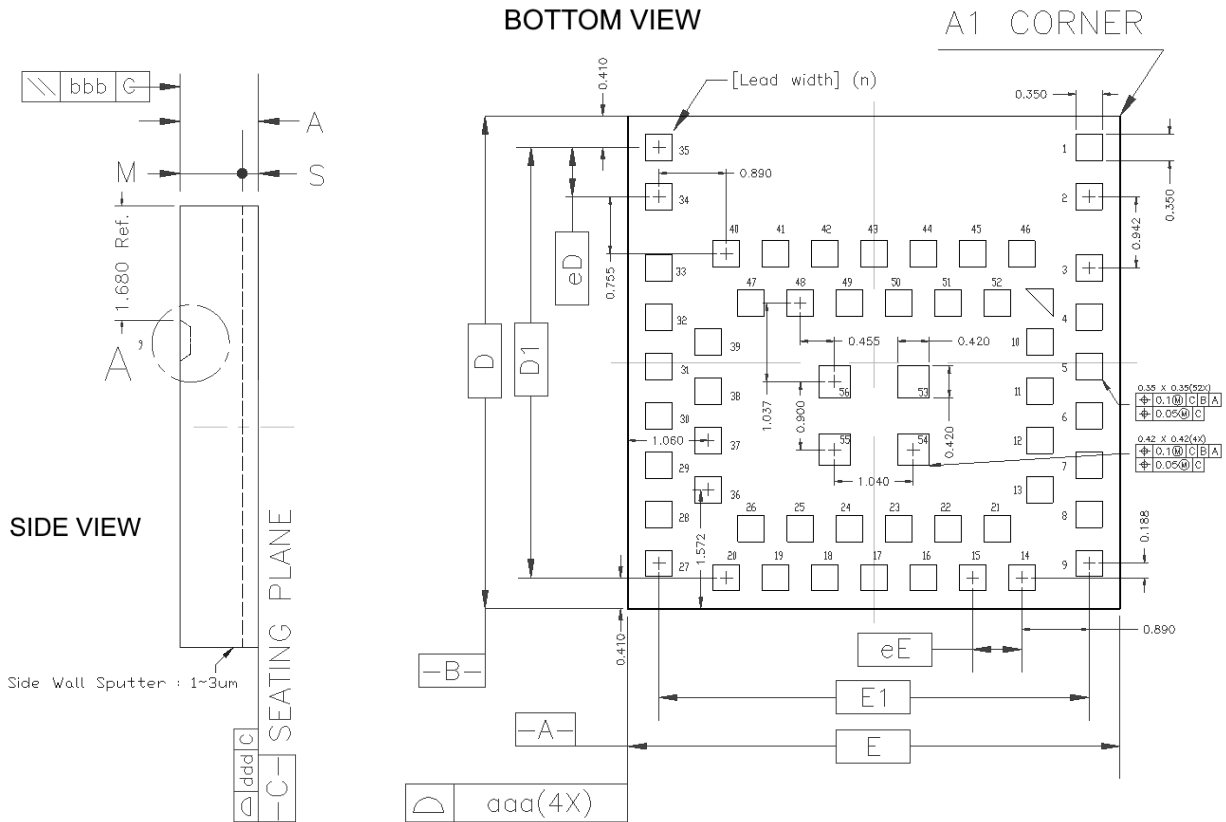

Description	Symbol	Common Dimensions			
		MIN	NOM	MAX	
Package :		PIM			
Body Size:	X	E	6.400	6.500	6.600
	Y	D	6.400	6.500	6.600
Lead Pitch :	X	eE	0.650		
	Y	eD	0.650		
Total Thickness :	A	1.150 \pm 0.100			
Mold Thickness :	M	0.910 Ref.			
Substrate Thickness :	S	0.240 Ref.			
Lead width:		0.350X0.350/0.420X0.420			
Package Edge Tolerance :	aaa	0.100			
Mold Flatness :	bbb	0.100			
Coplanarity:	ddd	0.100			
Lead Count :	n	56			
Edge Lead Center to Center :	X	E1	5.680		
	Y	D1	5.680		

Figure 4: ANNA-B412 mechanical outline

6 Qualification and approvals

6.1 Country approvals

The ANNA-B412 module is certified for use in the following countries/regions:

Country/region	ANNA-B412
Europe	Pending
USA	Pending
Canada	Pending
Japan	Pending
Taiwan	Pending
South Korea	Pending
Brazil	Pending
Australia	Pending
New Zealand	Pending
South Africa	Pending

 For more information about the regulatory requirements that must be met when using ANNA-B412 in an end product, see also the certification application notes in the ANNA-B4 system integration manual [3].

6.2 Bluetooth qualification



ANNA-B412 module is qualified as an end product in accordance with the Bluetooth 5.1 specification.

Product type	QD ID	Listing date
End product	TBD	TBD

Table 15: ANNA-B412 Bluetooth qualified design ID

7 Product handling

7.1 Packaging

ANNA-B412 modules are delivered as hermetically sealed, reeled tapes to enable efficient production, production lot set-up and tear-down.

7.2 Reels

Detailed information about the reel types for ANNA-B4 modules are provided in Table 16.

Model	Reel Type	Reel Part Number	Qty
ANNA-B412	7"	MYR-131-BB	500 pcs/reel

Table 16: Reel type for ANNA-B412

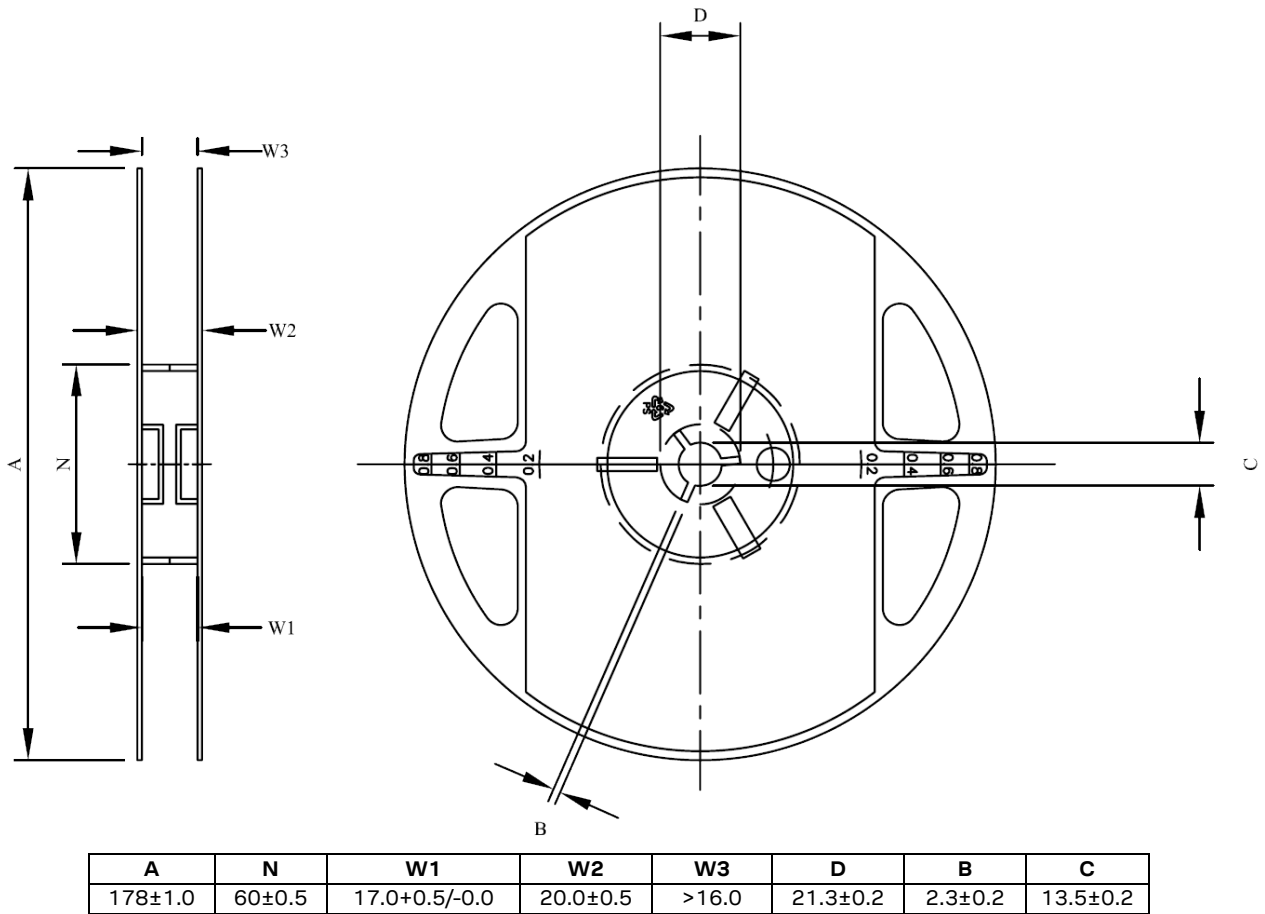

Figure 5: Seven-inch reel for ANNA-B4 modules

7.3 Tapes

Figure 6 shows the position and orientation of ANNA-B4 modules as they are delivered on tape. The dimensions of the tapes are specified in Figure 7.



Figure 6: Orientation of ANNA-B4 modules on tape

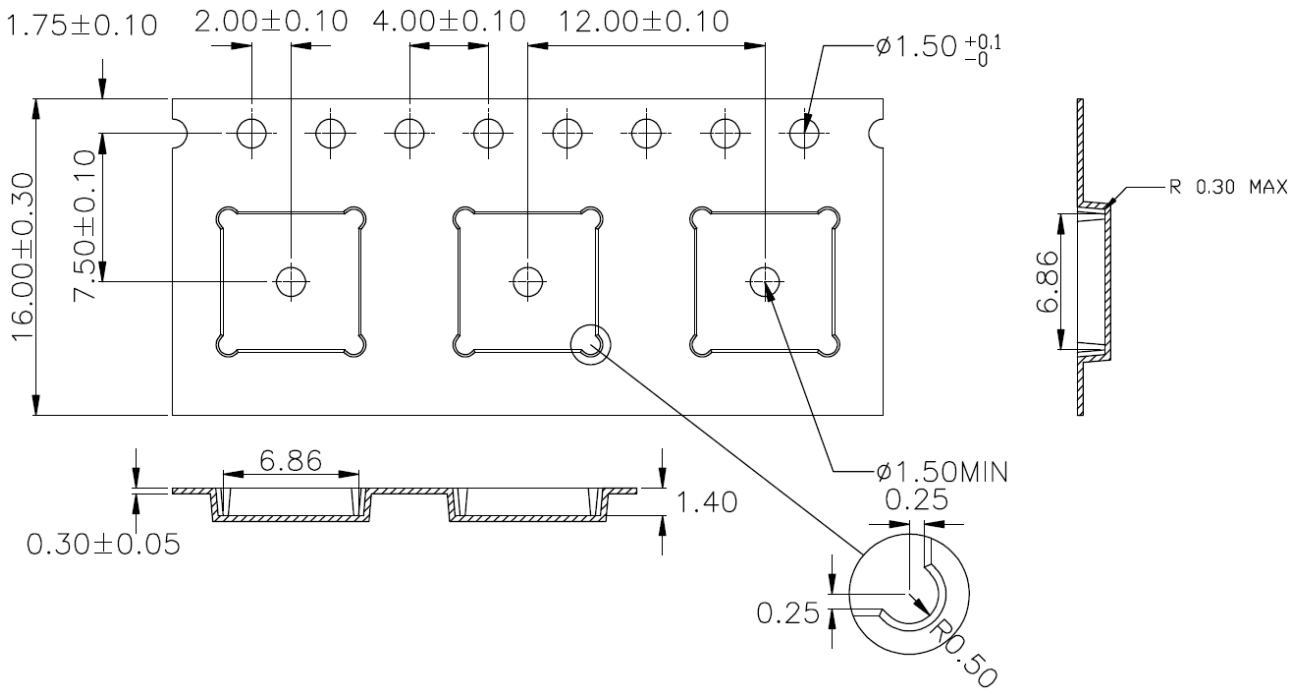

Sprocket hole pitch cumulative tolerance ± 0.20
 Carrier camber is within 1 mm in 250 mm
 Material: Black Conductive Polyester Allow (ABS+PS)
 All dimensions meet EIA-481-D requirements
 Thickness: 0.30 ± 0.05 mm
 Surface resistivity: $105 \sim 109 \Omega/\text{sq}$.

Figure 7: ANNA-B4 tape dimensions

7.4 Moisture sensitivity levels

-  ANNA-B412 is Moisture Sensitive Devices (MSD) in accordance with the IPC/JEDEC specification. The Moisture Sensitivity Level (MSL) relates to the required packaging and handling precautions. ANNA-B412 is rated at MSL level 3.

 See also the MSL standard IPC/JEDEC J-STD-020, which can be downloaded from www.jedec.org.

7.5 Reflow soldering

Reflow profiles are to be selected according to u-blox recommendations described in the ANNA-B412 system integration manual [3].

-  Failure to observe these recommendations can result in severe damage to the device.

7.6 ESD precautions

-  ANNA-B412 modules contain highly sensitive electronic circuitry and are Electrostatic Sensitive Devices (ESD). Handling ANNA-B412 modules without proper ESD protection may destroy or damage them permanently.

ANNA-B412 modules are electrostatic sensitive devices (ESD), which means that special ESD precautions, typically applied to ESD sensitive components, must be strictly observed. See also [Maximum ESD ratings](#).

Proper ESD handling and packaging procedures must be applied throughout the processing, handling, and operation stages of any application that incorporates ANNA-B412. ESD precautions are of particular importance when handling the application board on to which ANNA-B412 is mounted. See also the system integration manual [3].

-  Failure to observe these recommendations can result in severe damage to ANNA-B412 devices.

8 Labelling and ordering information

8.1 Product marking

Figure 8 and Table 17 describe the laser markings on the ANNA-B412 modules.

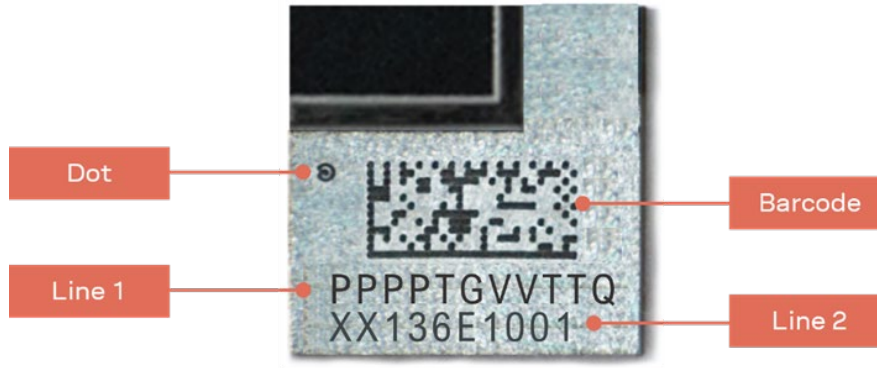

Figure 8: Product marking layout

Item	Description	Example																																																	
Dot	Pin 1 corner indication for assembly orientation	-																																																	
Line 1	Product name, major version, and product grade																																																		
Pos 1–8	Product name	ANNAB412																																																	
Pos 9-10	Major product version	00																																																	
Pos 11	Quality grade	B																																																	
Line 2	Minor version and production date																																																		
Pos 1–2	Minor product version	00																																																	
Pos 3	Last digit of production year	1																																																	
Pos 4–5	Week number of production date	36																																																	
Pos 6–7	Assembly mother lot, last digits	E1																																																	
Pos 8–10	Assembly sub lot number	001																																																	
2D barcode	<table border="1" style="width:100%; text-align:center;"> <tr> <td>1</td><td>2</td><td>3</td><td>4</td><td>5</td><td>6</td><td>7</td> <td>8</td><td>9</td><td>10</td> <td>11</td><td>12</td><td>13</td><td>14</td><td>15</td><td>16</td> </tr> <tr> <td colspan="2">Year</td> <td colspan="5">Assembly mother lot#</td> <td colspan="3">Sub lot#</td> <td colspan="2">Strip#</td> <td colspan="2">X axis</td> <td colspan="2">Y axis</td> </tr> <tr> <td>Example</td> <td>8</td> <td>3</td><td>6</td><td>U</td><td>B</td><td>E</td><td>1</td> <td>0</td><td>0</td><td>1</td> <td>0</td><td>1</td> <td>0</td><td>1</td> <td>0</td><td>1</td> </tr> </table>	1	2	3	4	5	6	7	8	9	10	11	12	13	14	15	16	Year		Assembly mother lot#					Sub lot#			Strip#		X axis		Y axis		Example	8	3	6	U	B	E	1	0	0	1	0	1	0	1	0	1	
	1	2	3	4	5	6	7	8	9	10	11	12	13	14	15	16																																			
	Year		Assembly mother lot#					Sub lot#			Strip#		X axis		Y axis																																				
Example	8	3	6	U	B	E	1	0	0	1	0	1	0	1	0	1																																			

Table 17: ANNA-B412 laser marking data

See also [Product identifiers](#) and [Identification codes](#).

8.2 Product identifiers

Table 18 describes the three product identifiers; specifically, the Product name, Ordering code and Type number.

Format	Description	Nomenclature
Product name	Describes the form factor, platform technology and platform variant. Used mostly in product documentation like this data sheet, the product name represents the most common identity for all u-blox products	PPPPTGVV (Line1, position 1–8)
Ordering code	Comprises the product name – with additional identifiers to describe the major product version and quality grade	PPPPTGVVTTQ (Line1, position 1–11)
Type number	Comprises the product name and ordering code – with additional identifiers to describe minor product versions.	PPPP -TGVV-TTQ-XX (Line1, position 1–11) (Line 2, position 1–2)

Table 18: Product code formats

8.3 Identification codes

Table 19 explains the parts of the product code.

Code	Meaning	Example
PPPP	Form factor	ANNA
TG	Platform (Technology and Generation) <ul style="list-style-type: none"> • T – Dominant technology, For example, <ul style="list-style-type: none"> ◦ W: Wi-Fi, ◦ B: Bluetooth • G – Generation 	B4: Bluetooth Generation 4
VV	Variant based on the same platform; range [00...99]	12: default mounting, with internal antenna
TT	Major Product Version	00: first revision
Q	Quality grade <ul style="list-style-type: none"> • A: Automotive • B: Professional • C: Standard 	B: professional grade
XX	Minor product version (not relevant for certification)	Default value is 00

Table 19: Part identification code

8.4 Ordering information

Ordering code	Product
ANNA-B412-00B	ANNA-B412 module with u-connectXpress software and the option to use either an internal antenna or an external antenna.

Table 20: Product ordering codes

Appendix

A Glossary

Abbreviation	Definition
ADC	Analog to digital converter
BLE	Bluetooth low energy
BPF	Band pass filter
CTS	Clear to send
ESD	Electro static discharge
FCC	Federal Communications Commission
GATT	Generic ATtribute profile
GPIO	General purpose input/output
IC	Industry Canada
I ² C	Inter-integrated circuit
LPO	Low power oscillator
MCU	Micro controller unit
MSD	Moisture sensitive device
RF	Radio frequency
RTOS	Real time operating system
SiP	System in package
SPI	Serial peripheral interface
UART	Universal asynchronous receiver/transmitter

Table 21: Explanation of the abbreviations and terms used

Related documents

- [1] u-blox packaging information guide, [UBX-14001652](#)
- [2] u-connectXpress AT commands manual, [UBX-14044127](#)
- [3] ANNA-B4 system integration manual, [UBX-21000517](#)
- [4] u-connectXpress software user guide, [UBX-16024251](#)
- [5] ANNA-B402 product summary, [UBX-20017979](#)
- [6] ANNA-B412 product summary, [UBX-21025292](#)
- [7] ANNA-B112 data sheet, [UBX-18011707](#)
- [8] s-center user guide, [UBX-1601226](#)

 For product change notifications and regular updates of u-blox documentation, register on our website, www.u-blox.com.

Revision history

Revision	Date	Name	Comments
R01	08-Oct-2021	asoh, yach	Initial release.
R02	19-Oct-2021	lalb	Revised document metadata disclosure restriction class.

Contact

For complete contact information, visit us at www.u-blox.com.

u-blox Offices

North, Central and South America

u-blox America, Inc.

Phone: +1 703 483 3180
E-mail: info_us@u-blox.com

Regional Office West Coast:

Phone: +1 408 573 3640
E-mail: info_us@u-blox.com

Technical Support:

Phone: +1 703 483 3185
E-mail: support@u-blox.com

Headquarters

Europe, Middle East, Africa

u-blox AG

Phone: +41 44 722 74 44
E-mail: info@u-blox.com
Support: support@u-blox.com

Asia, Australia, Pacific

u-blox Singapore Pte. Ltd.

Phone: +65 6734 3811
E-mail: info_ap@u-blox.com
Support: support_ap@u-blox.com

Regional Office Australia:

Phone: +61 3 9566 7255
E-mail: info_anz@u-blox.com
Support: support_ap@u-blox.com

Regional Office China (Beijing):

Phone: +86 10 68 133 545
E-mail: info_cn@u-blox.com
Support: support_cn@u-blox.com

Regional Office China (Chongqing):

Phone: +86 23 6815 1588
E-mail: info_cn@u-blox.com
Support: support_cn@u-blox.com

Regional Office China (Shanghai):

Phone: +86 21 6090 4832
E-mail: info_cn@u-blox.com
Support: support_cn@u-blox.com

Regional Office China (Shenzhen):

Phone: +86 755 8627 1083
E-mail: info_cn@u-blox.com
Support: support_cn@u-blox.com

Regional Office India:

Phone: +91 80 405 092 00
E-mail: info_in@u-blox.com
Support: support_in@u-blox.com

Regional Office Japan (Osaka):

Phone: +81 6 6941 3660
E-mail: info_jp@u-blox.com
Support: support_jp@u-blox.com

Regional Office Japan (Tokyo):

Phone: +81 3 5775 3850
E-mail: info_jp@u-blox.com
Support: support_jp@u-blox.com

Regional Office Korea:

Phone: +82 2 542 0861
E-mail: info_kr@u-blox.com
Support: support_kr@u-blox.com

Regional Office Taiwan:

Phone: +886 2 2657 1090
E-mail: info_tw@u-blox.com
Support: support_tw@u-blox.com