

MAX77540

16V_{IN}/6A, Dual-Phase High-Efficiency Buck Converter

General Description

The MAX77540 is a high-efficiency step-down converter with two 3A switching phases. It uses an adaptive COT (constant on-time) current-mode control architecture and the two 3A switching phases can be configured as either one (2Φ, 6A) or two (1Φ, 3A each) outputs. Its wide input voltage range enables a direct conversion for sub-1V outputs from 3-cell Li+ batteries, USB PD, and 12V_{DC} supply rails. The output voltages are preset with resistors and are further adjustable through an I²C-compatible interface. With 94% peak efficiency, low quiescent current, and compact solution size, the MAX77540 is ideal for battery powered, space-constraint equipment.

Programmable switching frequency, frequency tracking, spread-spectrum, and ultrasonic mode allow easier system optimization for noise-sensitive applications. Dedicated EN, POK, and FPWMB pins provide options for direct hardware control, while more programmable options, such as soft-start/stop and ramp-up/down slew-rates, are available through I²C. An array of built-in protections insures safe operation under abnormal operating conditions.

Applications

- 2/3-Cell Li+ and USB-C Power Delivery Systems
- Audio and Video Equipment
- Microprocessors, field-programmable gate arrays (FPGAs), digital signal processors (DSPs), and application-specific integrated circuits (ASICs)
- Networking and PCIe®/redundant array of inexpensive disks (RAID) Cards

Benefits and Features

- 4V to 16V Input Voltage Range
- 0.5V to 5.2V Output Voltage Range
- Resistor Configurable Default V_{OUT}
- Two 3A Bucks (1Φ) or One 6A Buck (2Φ)
- ±0.5% V_{OUT} Accuracy (Default V_{OUT} at 25°C)
- 94% Peak Efficiency (7.6V_{IN}, 3.3V_{OUT}, 1MHz)
- Auto SKIP/PWM and Low-Power Mode
- 98% Max. Duty Cycle Dropout Operation
- Programmable Soft-Start/Stop and Ramp-Up/Down Slew Rates
- Pre-Biased Startup and Active Output Discharge
- Programmable Inductor Peak Current Limits
- 0.5/1.0/1.6MHz Nominal Switching Frequency
- Spread-Spectrum Modulation
- Internal/External Frequency Tracking
- Ultrasonic Mode
- Dedicated EN, POK, and FPWM Pins
- Undervoltage lockout (UVLO), Thermal Shutdown, and Short-Circuit Protection
- High-Speed I²C I/F with 3-Slave Address Options
- 30-WLP (2.51mm x 2.31mm) and 24-FC2QFN (3mm x 3mm) Packages
- Less than 55mm² Total Solution Size

Ordering Information appears at end of data sheet.

Typical Applications Circuit

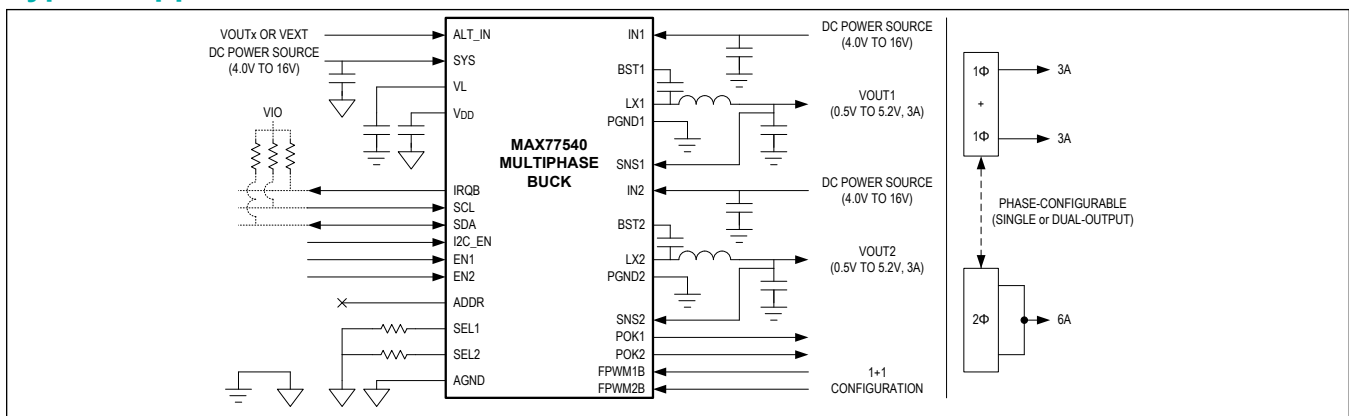

TABLE OF CONTENTS

| | |
|---|----|
| General Description | 1 |
| Applications | 1 |
| Benefits and Features | 1 |
| Typical Applications Circuit | 1 |
| Absolute Maximum Ratings | 6 |
| Recommended Operating Conditions | 6 |
| Package Information | 6 |
| 30 WLP | 6 |
| Electrical Characteristics—Top-Level | 7 |
| Electrical Characteristics—Dual-Phase Configurable Buck Converter | 9 |
| Electrical Characteristics—I ² C Serial Interface | 13 |
| Typical Operating Characteristics | 15 |
| Bump Configuration | 19 |
| 30 WLP | 19 |
| Bump Descriptions | 19 |
| Detailed Description—Top-Level | 22 |
| Dedicated Internal Supplies | 22 |
| Alternative Low-Voltage Input (ALT_IN) | 22 |
| Output Enable Control | 23 |
| Undervoltage Lockout | 23 |
| Thermal Warnings and Thermal Shutdown (T _{SHDN}) | 23 |
| Interrupt (IRQB) and Mask | 24 |
| Register Reset Condition | 25 |
| Detailed Description—Dual-Phase Configurable Buck Converter | 25 |
| Buck Converter Control Scheme | 25 |
| Buck Operating Modes | 26 |
| SKIP Mode | 26 |
| Low-Power SKIP (LP-SKIP) Mode | 27 |
| Forced-PWM (FPWM) Mode | 27 |
| Dropout Mode | 27 |
| Switching Frequency | 27 |
| Phase Configuration | 27 |
| Default Output Voltage Selection (SELx) | 28 |
| Output Voltage Setting | 30 |
| Soft-Start and Soft-Stop | 30 |
| Dynamic Output Voltage Scaling | 31 |
| Output Voltage Active Discharge | 31 |
| Bootstrap Refresh | 31 |

TABLE OF CONTENTS (CONTINUED)

| | |
|---|----|
| Frequency Tracking (FTRAK) | 32 |
| Spread-Spectrum Modulation | 32 |
| Pseudo-Random Pattern | 33 |
| Triangular Pattern | 33 |
| Inductor Current Limits | 34 |
| Power-OK (POK) | 35 |
| Fault Protection | 35 |
| Detailed Description—I ² C Serial Interface | 36 |
| Slave Address | 36 |
| Register Map | 37 |
| MAX77540 WLP Package | 37 |
| Register Details | 38 |
| Applications Information—Dual-Phase Configurable Buck Converter | 49 |
| Inductor Selection | 49 |
| Input Capacitor Selection | 49 |
| Output Capacitor Selection | 49 |
| General PCB Layout Guidelines | 50 |
| Typical Application Circuits | 51 |
| 1+1 Phase Configuration with I ² C Enabled | 51 |
| 1+1 Phase Configuration without I ² C | 52 |
| Dual-Phase Configuration with I ² C Enabled | 53 |
| Dual-Phase Configuration without I ² C | 54 |
| Ordering Information | 54 |
| Revision History | 55 |

LIST OF FIGURES

| | |
|---|----|
| Figure 1. Alternative Input Switch-Over Circuit | 22 |
| Figure 2. Thermal Monitor State Diagram | 24 |
| Figure 3. Functional Block Diagram | 25 |
| Figure 4. Buck Operating Modes | 26 |
| Figure 5. Frequency Tracking | 32 |
| Figure 6. Pseudo-Random Modulator Engine | 33 |
| Figure 7. 4-Bit Pseudo-Random Modulation Signal Example | 33 |
| Figure 8. Triangular Modulator Engine | 34 |
| Figure 9. 4-Bit Triangular Modulation Signal Example | 34 |
| Figure 10. Fault Protection State Diagram | 36 |

LIST OF TABLES

| | |
|--|----|
| Table 1. V _{DD} and I ² C Enable Truth Table | 22 |
| Table 2. Phase Configuration Selection | 28 |
| Table 3. Buck Output Sensing Assignment | 28 |
| Table 4. Default V _{OUT1} Selection | 28 |
| Table 5. Default V _{OUT2} Selection | 29 |
| Table 6. Buck Output Voltage Range | 30 |
| Table 7. Mx_FSREN Effect on Buck Behavior | 31 |
| Table 8. Bootstrap Refresh Interval Selection | 32 |
| Table 9. Mx_FTRAK Enable Truth Table | 32 |
| Table 10. I ² C Slave Address Options | 36 |
| Table 11. Recommended Inductors | 49 |
| Table 12. Recommended Minimum Effective Output Capacitance | 49 |

Absolute Maximum Ratings

| | | | |
|-------------------------------|--|---|--|
| SYS to AGND | -0.3V to +17.6V | FPWM1B, FPWM2B to AGND | -0.3V to +6.0V |
| ALT_IN to AGND | -0.3V to +6.0V | POK1, POK2 to AGND | -0.3V to +6.0V |
| V _{DD} to AGND | -0.3V to +2.2V | SCL, SDA, IRQB to AGND | -0.3V to +6.0V |
| V _L to PGND | -0.3V to +2.2V | ADDR, SEL1, SEL2 to AGND | -0.3V to MIN(V _{DD} + 0.3, +2.2)V |
| I2C_EN to AGND | -0.3V to MIN(V _{SYS} + 0.3, +17.6)V | PGND1, PGND2 to AGND | -0.3V to +0.3V |
| EN1, EN2 to AGND | -0.3V to MIN(V _{SYS} + 0.3, +17.6)V | Continuous Power Dissipation (JESD51-7, T _A = +70°C) | |
| IN1 to PGND1 | -0.3V to +17.6V | 30 WLP (Derate 20.25mW/°C above +70°C) | 1620mW |
| IN2 to PGND2 | -0.3V to +17.6V | Junction Temperature | +150°C |
| BSTx to LXx | -0.3V to +2.2V | Storage Temperature Range | -65°C to +150°C |
| SNS1, SNS2 to AGND | -0.3V to +6.0V | Soldering Temperature (reflow) | +260°C |

Note 1: LXx has internal clamp diodes to its corresponding PGNDx and INx. Applications that forward bias these diodes should take care not to exceed the IC's package power dissipation limits.

Stresses beyond those listed under "Absolute Maximum Ratings" may cause permanent damage to the device. These are stress ratings only, and functional operation of the device at these or any other conditions beyond those indicated in the operational sections of the specifications is not implied. Exposure to absolute maximum rating conditions for extended periods may affect device reliability.

Recommended Operating Conditions

| PARAMETER | SYMBOL | CONDITION | TYPICAL RANGE | UNIT |
|----------------------------|------------------|--|---------------|------|
| Input Voltage Range | V _{IN} | | 4 to 16 | V |
| Output Current Range | I _{OUT} | For continuous operation at 3A, the junction temperature (T _J) is limited to +105°C. If the junction temperature is higher than +105°C, the expected lifetime at 3A continuous operation is derated. | 0 to 3 | A |
| Junction Temperature Range | T _J | | -40 to +125 | °C |

Note: These limits are not guaranteed.

Package Information

30 WLP

| | |
|--|--|
| Package Code | W302P2Z+1 |
| Outline Number | 21-100414 |
| Land Pattern Number | Refer to Application Note 1891 |
| Thermal Resistance, Four-Layer Board: | |
| Junction to Ambient (θ _{JA}) | 49.38°C/W |

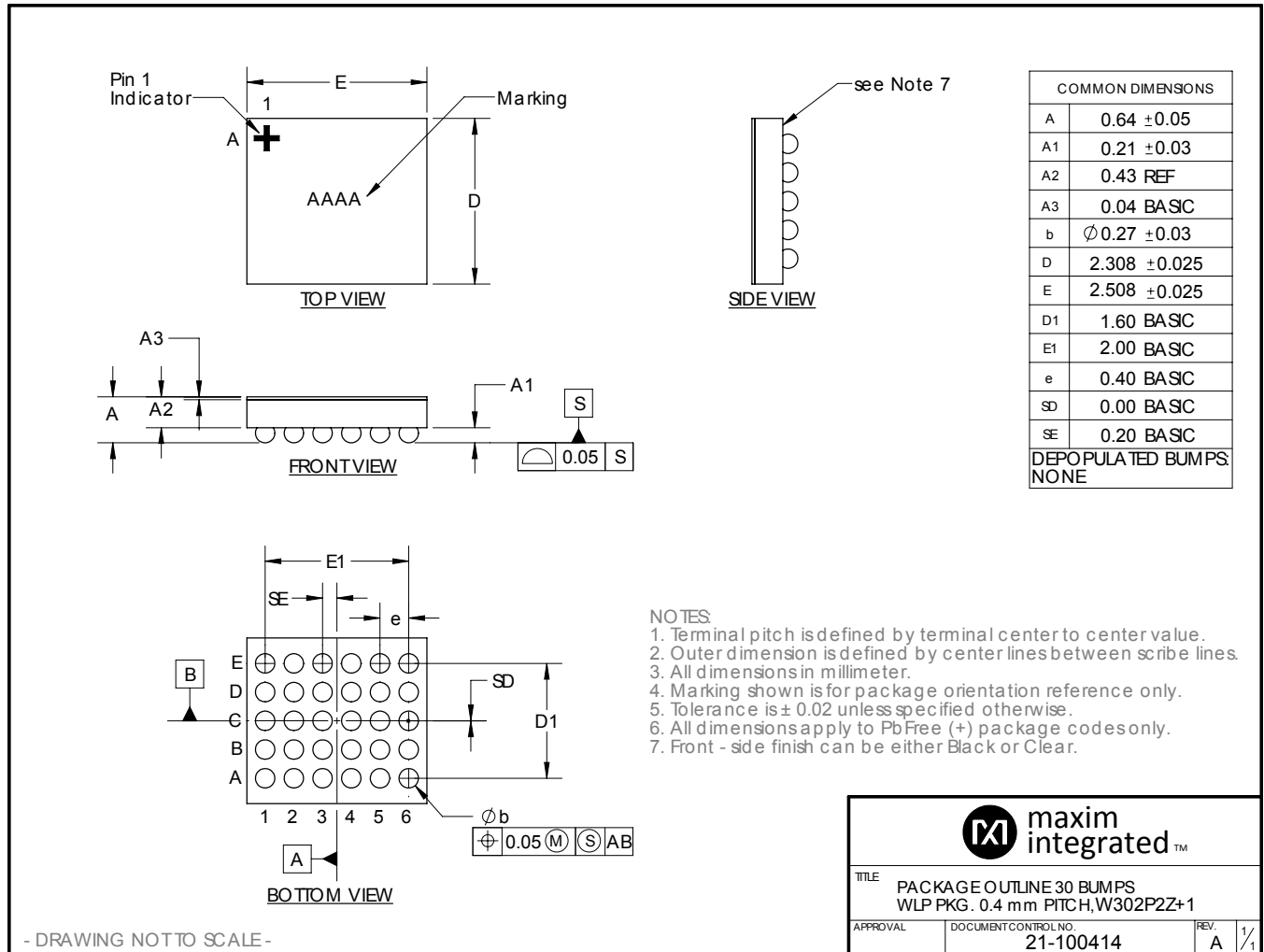

For the latest package outline information and land patterns (footprints), go to www.maximintegrated.com/packages. Note that a "+", "#", or "-" in the package code indicates RoHS status only. Package drawings may show a different suffix character, but the drawing pertains to the package regardless of RoHS status.

Package thermal resistances were obtained using the method described in JEDEC specification JESD51-7, using a four-layer board. For detailed information on package thermal considerations, refer to www.maximintegrated.com/thermal-tutorial.

Electrical Characteristics—Top-Level

(V_{sys} = V_{IN1} = V_{IN2} = 12V, V_{OUT1} = 3.3V, V_{OUT2} = 5.0V, Single-phase Configuration (1Φ + 1Φ), V_{I2C_EN} = 1.8V, T_A = T_J = -40°C to +125°C, typical values are at T_A = T_J = +25°C, unless otherwise noted. Note 2.)

| PARAMETER | SYMBOL | CONDITIONS | MIN | TYP | MAX | UNITS |
|---|---------------------|--------------------------|-----|-----|-----|-------|
| INPUT VOLTAGE AND SUPPLY CURRENT | | | | | | |
| SYS Voltage Range | V _{sys} | | 4 | | 16 | V |
| SYS Undervoltage Lockout (UVLO) | V _{UVLO_R} | V _{sys} rising | 3.8 | 3.9 | 4.0 | V |
| | V _{UVLO_F} | V _{sys} falling | 3.5 | 3.7 | 3.8 | |
| Power-On Reset (POR) Threshold (Note 7) | V _{POR} | V _{sys} falling | | 1.7 | | V |

Electrical Characteristics—Top-Level (continued)

(V_{SYS} = V_{IN1} = V_{IN2} = 12V, V_{OUT1} = 3.3V, V_{OUT2} = 5.0V, Single-phase Configuration (1Φ + 1Φ), V_{I2C_EN} = 1.8V, T_A = T_J = -40°C to +125°C, typical values are at T_A = T_J = +25°C, unless otherwise noted. Note 2.)

| PARAMETER | SYMBOL | CONDITIONS | | MIN | TYP | MAX | UNITS |
|--|--------------------------|--|---------------------------------|-----------------------|------|-----------------------|-------|
| Shutdown Supply Current (Note 3) | I _{SHDN} | V _{I2C_EN} = V _{ENx} = 0V | T _A = -40°C to +85°C | | 1.5 | 5.5 | μA |
| | | | T _A = +125°C | | | 15 | |
| Standby Supply Current (Note 3) | I _{STBY} | V _{ALT_IN} = 0V, EN _{FTMON} = 0, all Bucks are disabled | T _A = -40°C to +85°C | | 25 | 50 | μA |
| | | | T _A = +125°C | | | 70 | |
| Quiescent Supply Current with External ALT_IN (Note 3) | I _Q | V _{ALT_IN} = V _{EXT} = 3.3V, V _{OUT} > V _{OUT(TARGET)} , both Buck phases are enabled, SKIP or LP-SKIP mode, no load | | | 10 | 20 | μA |
| Quiescent Supply Current in LP-SKIP Mode (Note 3) | I _{Q_LP-SKIP} | V _{ALT_IN} = 0V, V _{OUT} > V _{OUT(TARGET)} , no load | Only one Buck phase is enabled | | 215 | 300 | μA |
| | | | Both Buck phases are enabled | | 310 | 400 | |
| Quiescent Supply Current in SKIP Mode (Note 3) | I _{Q_SKIP} | V _{ALT_IN} = 0V, V _{OUT} > V _{OUT(TARGET)} , no load | Only one Buck phase is enabled | | 260 | 350 | μA |
| | | | Both Buck phases are enabled | | 400 | 500 | |
| INTERNAL BIAS SUPPLY | | | | | | | |
| V _L Regulator Voltage | V _L | (Note 4) | | | 1.8 | | V |
| V _{DD} Regulator Voltage | V _{DD} | (Note 4) | | | 1.8 | | V |
| V _{DD} Undervoltage Lockout (UVLO) | V _{DD_UVLO_F} | (Note 4) | | | 1.55 | | V |
| ALT_IN Switch-Over Threshold | V _{SWO} | V _{ALT_IN} Rising, 100mV hysteresis, V _L & V _{DD} input switches from SYS to ALT_IN above this threshold (WLP package only) | | 2.7 | 2.8 | 2.9 | V |
| ALT_IN Valid Voltage Range | V _{ALT_IN} | | | V _{SWO} | | 5.5 | V |
| ALT_IN Shutdown Supply Current | I _{SHDN_ALT_IN} | V _{I2C_EN} = V _{ENx} = 0V, V _{ALT_IN} = 3.3V | | | 0.2 | | μA |
| THERMAL PROTECTION | | | | | | | |
| Thermal Warning 1 | T _{J120} | T _J rising, 15°C hysteresis | | | +120 | | °C |
| Thermal Warning 2 | T _{J140} | T _J rising, 15°C hysteresis | | | +140 | | °C |
| Thermal Shutdown (T _{SHDN}) | T _{SHDN} | T _J rising, 15°C hysteresis | | | +165 | | °C |
| LOGIC INPUT AND OUTPUT | | | | | | | |
| ADDR Input Logic High Threshold | V _{IH_ADDR} | | | 0.8 x V _{DD} | | | V |
| ADDR Input Logic Low Threshold | V _{IL_ADDR} | | | | | 0.2 x V _{DD} | V |
| FPWMxB Input Logic High Threshold | V _{IH_FPWMxB} | | | 1.44 | | | V |

Electrical Characteristics—Top-Level (continued)

(V_{SYS} = V_{IN1} = V_{IN2} = 12V, V_{OUT1} = 3.3V, V_{OUT2} = 5.0V, Single-phase Configuration (1Φ + 1Φ), V_{I2C_EN} = 1.8V, T_A = T_J = -40°C to +125°C, typical values are at T_A = T_J = +25°C, unless otherwise noted. Note 2.)

| PARAMETER | SYMBOL | CONDITIONS | | MIN | TYP | MAX | UNITS |
|--|------------------------|--|------------------------|-----|--------|-------|-------|
| FPWMxB Input Logic Low Threshold | V _{IL_FPWMxB} | | | | | 0.54 | V |
| I2C_EN, ENx Input Logic High Threshold | V _{IH_EN} | | | 1.1 | | | V |
| I2C_EN, ENx Input Logic Low Threshold | V _{IL_EN} | | | | | 0.4 | V |
| IRQB Output Logic Low Threshold | V _{OL_IRQB} | Sinking 2mA | | | | 0.4 | V |
| POKx Output Logic Low Threshold | V _{OL_POK} | Sinking 2mA | | | | 0.4 | V |
| ADDR Leakage Current | I _{LKG_ADDR} | V _{DD} = 1.8V, V _{ADDR} = 0V and 1.8V | T _A = +25°C | -1 | ±0.001 | +1 | μA |
| | | | T _A = +85°C | | | ±0.01 | |
| I2C_EN, ENx Leakage Current | I _{LKG_EN} | V _{SYS} = 16V, V _{ENx} = 0V and 16V | T _A = +25°C | | ±0.1 | | μA |
| | | | T _A = +85°C | | | ±0.5 | |
| IRQB Leakage Current | I _{LKG_IRQB} | IRQB set to Hi-Z (i.e., No Interrupt Pending), V _{IRQB} = 0V and 5.5V | | -1 | | +1 | μA |
| POKx Leakage Current | I _{LKG_POK} | POKx = High (Hi-Z), V _{POKx} = 5.5V, T _A = +85°C | | | | 1 | μA |

Electrical Characteristics—Dual-Phase Configurable Buck Converter

(V_{SYS} = V_{IN1} = V_{IN2} = 12V, Single-phase Configuration (1Φ+1Φ), V_{OUT1} = 3.3V, V_{OUT2} = 5.0V, V_{I2C_EN} = 1.8V, T_A = T_J = -40°C to +125°C, typical values are at T_A = T_J = +25°C, unless otherwise noted. Note 2.)

| PARAMETER | SYMBOL | CONDITIONS | MIN | TYP | MAX | UNITS |
|---------------------------------------|----------------------|--|------|-----|------|-------|
| INPUT SUPPLY | | | | | | |
| Input Voltage Range | V _{INx} | | 4 | | 16 | V |
| DC OUTPUT VOLTAGE AND ACCURACY | | | | | | |
| Output Voltage Range | V _{OUT_RNG} | Low-range (Mx_RNG[1:0] = 0x0) | 0.5 | | 1.2 | V |
| | | Mid-range (Mx_RNG[1:0] = 0x1) | 1 | | 2.4 | |
| | | High-range (Mx_RNG[1:0] = 0x2) | 2 | | 5.2 | |
| Line Regulation | | 1Φ, FPWM Mode, V _{INx} = 4V to 16V, V _{OUT} = Default, I _{OUT} = 0A | -0.1 | | +0.1 | %/V |
| Load Regulation | | 1Φ, FPWM Mode, I _{OUT} = 0A to 3A (Note 7) | | 0.1 | | %/A |

Electrical Characteristics—Dual-Phase Configurable Buck Converter (continued)

(V_{SYS} = V_{IN1} = V_{IN2} = 12V, Single-phase Configuration (1Φ+1Φ), V_{OUT1} = 3.3V, V_{OUT2} = 5.0V, V_{I2C_EN} = 1.8V, T_A = T_J = -40°C to +125°C, typical values are at T_A = T_J = +25°C, unless otherwise noted. Note 2.)

| PARAMETER | SYMBOL | CONDITIONS | MIN | TYP | MAX | UNITS | |
|---|----------------------|--|--|------------------------|------|-------|-----|
| DC Output Voltage Accuracy | V _{OUT_ACC} | 1Φ, FPWM Mode, V _{INx} = 4V to 16V, I _{OUT} = 0A | V _{OUT} < 0.6V | -2.5 | | +2.5 | % |
| | | | 0.6V ≤ V _{OUT} < 4.0V | -1.5 | | +1.5 | |
| | | | 4.0V ≤ V _{OUT} ≤ 5.2V | -1.0 | | +1.0 | |
| | | | V _{OUT} = Factory Default, T _A = +25°C | -0.5 | | +0.5 | |
| POWER STAGE | | | | | | | |
| High-Side MOSFET Peak Current Limit | I _{PLIM} | Mx_ILIM[1:0] = 0x0 | 1.10 | 1.50 | 1.90 | A | |
| | | Mx_ILIM[1:0] = 0x1 | 1.85 | 2.25 | 2.65 | | |
| | | Mx_ILIM[1:0] = 0x2 | 2.55 | 3.00 | 3.45 | | |
| | | Mx_ILIM[1:0] = 0x3 | 4.05 | 4.50 | 4.95 | | |
| Low-Side MOSFET Valley Current Limit | I _{VLIM} | Tracks I _{PLIM} | | I _{PLIM} - 1A | | A | |
| Low-Side MOSFET Negative Current Limit | I _{NLIM} | FPWM Mode | -3.6 | -2.9 | -2.2 | A | |
| Low-Side MOSFET Zero-Crossing Current Threshold | I _{ZX} | SKIP or LP-SKIP Mode | | 150 | | mA | |
| High-Side MOSFET On-Resistance | R _{ON_HS} | 1Φ, I _{LXx} = 190mA | | 50 | 100 | mΩ | |
| Low-Side MOSFET On-Resistance | R _{ON_LS} | 1Φ, I _{LXx} = -190mA | | 32 | 64 | mΩ | |
| Nominal Switching Frequency | F _{SW} | FPWM Mode, No Load, No External Clock, T _A = +25°C (Note 5) | Mx_FREQ[1:0] = 0x0 | | 0.5 | MHz | |
| | | | Mx_FREQ[1:0] = 0x1 | | 1 | | |
| | | | Mx_FREQ[1:0] = 0x2 or 0x3 | | 1.6 | | |
| Minimum Switching Frequency | F _{SW(MIN)} | Mx_ULTRA = 0 | LP-SKIP Mode | 7.0 | 7.8 | 8.6 | kHz |
| | | | SKIP or DROPOUT Mode | 14.0 | 15.6 | 17.2 | |
| | | Mx_ULTRA = 1 | LP-SKIP, SKIP, or DROPOUT Mode | 90 | 100 | 110 | |
| Maximum Duty Cycle | D _{MAX} | Dropout Region (V _{OUT} falls below its regulation target) | 97 | 98 | | % | |

Electrical Characteristics—Dual-Phase Configurable Buck Converter (continued)

(V_{SYS} = V_{IN1} = V_{IN2} = 12V, Single-phase Configuration (1Φ+1Φ), V_{OUT1} = 3.3V, V_{OUT2} = 5.0V, V_{I2C_EN} = 1.8V, T_A = T_J = -40°C to +125°C, typical values are at T_A = T_J = +25°C, unless otherwise noted. Note 2.)

| PARAMETER | SYMBOL | CONDITIONS | MIN | TYP | MAX | UNITS |
|--------------------------------|-----------------------|---|---------------------------------|--------|-----|-------|
| LX Active Discharge Resistance | R _{AD1} | 1Φ, Buck Output disabled, Active Discharge enabled (Mx_ADIS1 = 1), Resistance from corresponding LX _X to PGND _X | | 1 | | Ω |
| | R _{AD100} | 1Φ, Buck Output disabled, Active Discharge enabled (Mx_ADIS100 = 1), Resistance from corresponding LX _X to PGND _X | | 100 | | |
| LX Leakage Current | I _{LKG_LX} | 1Φ, V _{LXx} = 0V and 16V | T _A = +25°C | 0.6 | 4.5 | μA |
| | | | T _A = -40°C to +85°C | 1 | | |
| SLEW RATE AND TIMING | | | | | | |
| Soft-Start Slew Rate (Note 6) | ΔV _{OUT} /Δt | SSTRT_SR[2:0] = 0x0 | | 0.15 | | mV/μs |
| | | SSTRT_SR[2:0] = 0x1 | | 0.625 | | |
| | | SSTRT_SR[2:0] = 0x2 | | 1.25 | | |
| | | SSTRT_SR[2:0] = 0x3 | | 2.5 | | |
| | | SSTRT_SR[2:0] = 0x4 | | 5 | | |
| | | SSTRT_SR[2:0] = 0x5 | | 10 | | |
| | | SSTRT_SR[2:0] = 0x6 | | 20 | | |
| | | SSTRT_SR[2:0] = 0x7 | | 40 | | |
| Soft-Stop Slew Rate (Note 6) | ΔV _{OUT} /Δt | SSTOP_SR[2:0] = 0x0 | | -0.15 | | mV/μs |
| | | SSTOP_SR[2:0] = 0x1 | | -0.625 | | |
| | | SSTOP_SR[2:0] = 0x2 | | -1.25 | | |
| | | SSTOP_SR[2:0] = 0x3 | | -2.5 | | |
| | | SSTOP_SR[2:0] = 0x4 | | -5 | | |
| | | SSTOP_SR[2:0] = 0x5 | | -10 | | |
| | | SSTOP_SR[2:0] = 0x6 | | -20 | | |
| | | SSTOP_SR[2:0] = 0x7 | | -40 | | |
| Ramp-Up Slew Rate (Note 6) | ΔV _{OUT} /Δt | Mx_RU_SR[2:0] = 0x0 | | 0.15 | | mV/μs |
| | | Mx_RU_SR[2:0] = 0x1 | | 0.625 | | |
| | | Mx_RU_SR[2:0] = 0x2 | | 1.25 | | |
| | | Mx_RU_SR[2:0] = 0x3 | | 2.5 | | |
| | | Mx_RU_SR[2:0] = 0x4 | | 5 | | |
| | | Mx_RU_SR[2:0] = 0x5 | | 10 | | |
| | | Mx_RU_SR[2:0] = 0x6 | | 20 | | |
| | | Mx_RU_SR[2:0] = 0x7 | | 40 | | |

Electrical Characteristics—Dual-Phase Configurable Buck Converter (continued)

(V_{SYS} = V_{IN1} = V_{IN2} = 12V, Single-phase Configuration (1Φ+1Φ), V_{OUT1} = 3.3V, V_{OUT2} = 5.0V, V_{I2C_EN} = 1.8V, T_A = T_J = -40°C to +125°C, typical values are at T_A = T_J = +25°C, unless otherwise noted. Note 2.)

| PARAMETER | SYMBOL | CONDITIONS | MIN | TYP | MAX | UNITS |
|---|---------------------------|--|--|--------|-----|-------------|
| Ramp-Down Slew Rate (Note 6) | $\Delta V_{OUT}/\Delta t$ | Mx_RD_SR[2:0] = 0x0 | | -0.15 | | mV/ μ s |
| | | Mx_RD_SR[2:0] = 0x1 | | -0.625 | | |
| | | Mx_RD_SR[2:0] = 0x2 | | -1.25 | | |
| | | Mx_RD_SR[2:0] = 0x3 | | -2.5 | | |
| | | Mx_RD_SR[2:0] = 0x4 | | -5 | | |
| | | Mx_RD_SR[2:0] = 0x5 | | -10 | | |
| | | Mx_RD_SR[2:0] = 0x6 | | -20 | | |
| | | Mx_RD_SR[2:0] = 0x7 | | -40 | | |
| Slew-Rate Accuracy | | REFDAC slew-rate accuracy | -5 | | +5 | % |
| Turn-On Delay | t_{DLY} | Delay from rising edge of ENx signal to V _{OUTx} ramping start-off | V _L is pre-enabled (I2C_EN = high) | 100 | 140 | μ s |
| | | | V _L is not pre-enabled (I2C_EN = low) | 435 | 535 | |
| FREQUENCY TRACKING | | | | | | |
| External Frequency Tracking Lockable Range (Note 6) | F _{FTRAK} | Expressed as a percentage of the nominal frequency set by Mx_FREQ[1:0] | 95 | | 105 | % |
| SPREAD-SPECTRUM | | | | | | |
| Modulation Frequency (Note 6) | F _{SS_MOD} | Mx_SS_FREQ[1:0] = 0x0 | | 1 | | kHz |
| | | Mx_SS_FREQ[1:0] = 0x1 | | 3 | | |
| | | Mx_SS_FREQ[1:0] = 0x2 | | 5 | | |
| | | Mx_SS_FREQ[1:0] = 0x3 | | 7 | | |
| Modulation Envelope | ΔF_{SS} | Mx_SS_ENV[1:0] = 0x1 | | ±8 | | % |
| | | Mx_SS_ENV[1:0] = 0x2 | | ±12 | | |
| | | Mx_SS_ENV[1:0] = 0x3 | | ±16 | | |
| POWER-OK AND SHORT-CIRCUIT PROTECTION | | | | | | |
| Power-OK Rising Threshold | V _{POK_R} | Expressed as a percentage of V _{OUT} | 77 | 82 | 87 | % |
| Power-OK Falling Threshold | V _{POK_F} | Expressed as a percentage of V _{OUT} | 73 | 78 | 83 | % |
| Short-Circuit Detection Threshold | V _{SCP} | V _{OUT} Falling, Expressed as a percentage of target V _{OUT} | | 20 | | % |
| Power-OK Fault Timeout (Note 6) | t_{POK_TO} | POK_TO[1:0] = 0x1 | | 25 | | ms |
| | | POK_TO[1:0] = 0x2 | | 50 | | |
| | | POK_TO[1:0] = 0x3 | | 100 | | |

Electrical Characteristics—I²C Serial Interface

(V_{SYS} = 12V, V_{I2C_EN} = 1.8V, T_A = T_J = -40°C to +125°C, typical values are at T_A = T_J = +25°C, unless otherwise noted. Note 2.)

| PARAMETER | SYMBOL | CONDITIONS | MIN | TYP | MAX | UNITS |
|--|---------------------|--|------|-----|------|-------|
| I/O STAGE | | | | | | |
| SCL, SDA Input Logic Low Threshold | V _{IL} | | | | 0.54 | V |
| SCL, SDA Input Logic High Threshold | V _{IH} | | 1.44 | | | V |
| SCL, SDA Input Hysteresis | V _{HYS} | | | 0.3 | | V |
| SDA Output Logic Low Threshold | V _{OL_SDA} | Sinking 20mA | | | 0.4 | V |
| SCL, SDA Input Leakage Current | I _{LKG} | V _{SCL} = V _{SDA} = 0V or 5.5V | -10 | | +10 | μA |
| SCL, SDA Pin Capacitance | | (Note 7) | | 10 | | pF |
| TIMING (STANDARD, FAST, AND FAST-MODE PLUS) | | | | | | |
| Clock Frequency | f _{SCL} | | | | 1 | MHz |
| Hold Time (REPEATED) START Condition | t _{HD;STA} | | 260 | | | ns |
| SCL LOW Period | t _{LOW} | | 500 | | | ns |
| SCL HIGH Period | t _{HIGH} | | 260 | | | ns |
| Setup Time REPEATED START Condition | t _{SU;STA} | | 260 | | | ns |
| Data Hold Time | t _{HD;DAT} | | 0 | | | μs |
| Data Setup Time | t _{SU;DAT} | | 50 | | | ns |
| Setup Time for STOP Condition | t _{SU;STO} | | 260 | | | ns |
| Bus Free Time between STOP and START Condition | t _{BUF} | | 0.5 | | | μs |
| Input Filter Suppressed Spike Pulse Width | t _{SP} | (Note 7) | | 50 | | ns |
| TIMING (HIGH-SPEED MODE) | | | | | | |
| Clock Frequency | f _{SCL} | High-speed mode | | | 3.4 | MHz |
| Setup Time REPEATED START Condition | t _{SU;STA} | | 160 | | | ns |
| Hold Time (REPEATED) START Condition | t _{HD;STA} | | 160 | | | ns |
| SCL LOW Period | t _{LOW} | | 160 | | | ns |
| SCL HIGH Period | t _{HIGH} | | 60 | | | ns |
| Data Setup Time | t _{SU;DAT} | | 10 | | | ns |
| Data Hold Time | t _{HD;DAT} | | 0 | | | μs |
| Setup Time for STOP Condition | t _{SU;STO} | | 160 | | | ns |

Electrical Characteristics—I²C Serial Interface (continued)

(V_{SYS} = 12V, V_{I2C_EN} = 1.8V, T_A = T_J = -40°C to +125°C, typical values are at T_A = T_J = +25°C, unless otherwise noted. Note 2.)

| PARAMETER | SYMBOL | CONDITIONS | MIN | TYP | MAX | UNITS |
|---|-----------------|------------|-----|-----|-----|-------|
| Input Filter Suppressed Spike Pulse Width | t _{SP} | (Note 7) | | 10 | | ns |

Note 2: The MAX77540 is tested under pulsed load conditions such that T_J ≈ T_A. Limits over the operating temperature range (T_J = -40°C to +125°C) are guaranteed by design and characterization using statistical process control methods. Note that the maximum ambient temperature consistent with this specification is determined by specific operating conditions, board layout, rated package thermal impedance, and other environmental factors.

Note 3: Supply Current = I_{SYS} + I_{IN1} + I_{IN2}

Note 4: See the [Dedicated Internal Supplies](#) section.

Note 5: Switching frequency is not set by a clock oscillator. F_{SW} varies depending on input voltage, output voltage, load, and spread-spectrum settings.

Note 6: Guaranteed by design. Production tested through scan.

Note 7: Not production tested. Design guidance only.

Typical Operating Characteristics

(V_{IN} = 12V, V_{OUT} = 3.3V, L = 1μH (Murata DFE2520F-1R0M), Skip Mode, Single Phase, F_{SW} = 1MHz, T_A = +25°C, unless otherwise noted.)

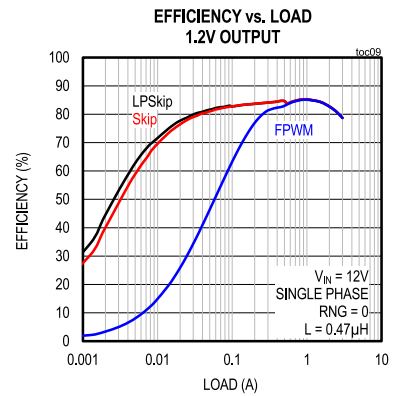
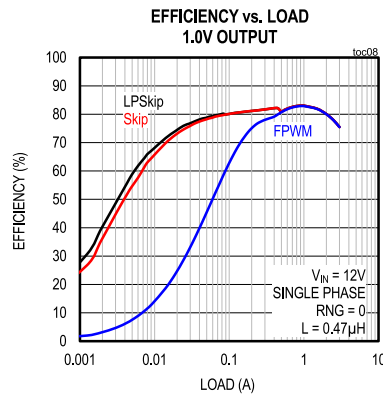
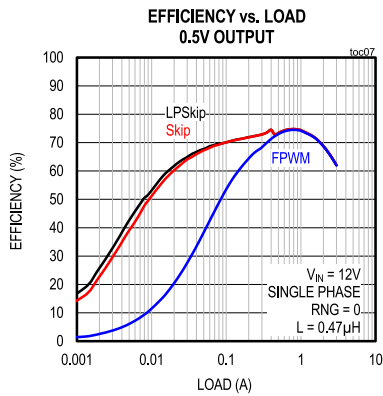
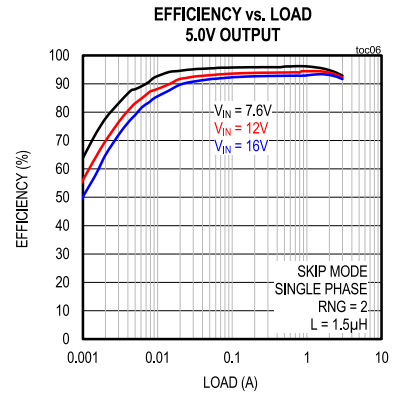
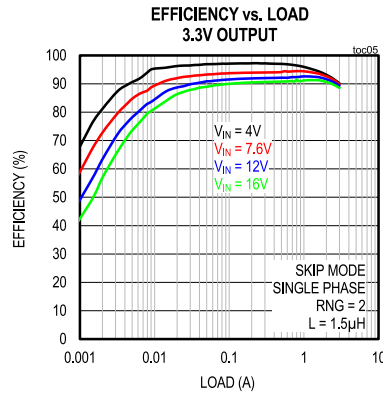
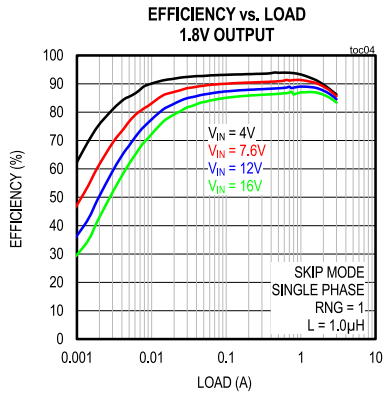
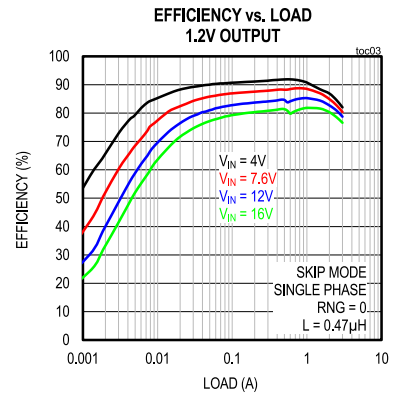
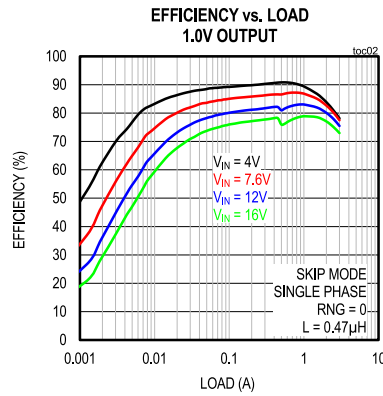
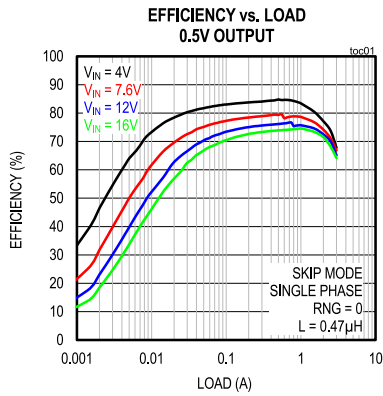

Typical Operating Characteristics (continued)

(V_{IN} = 12V, V_{OUT} = 3.3V, L = 1μH (Murata DFE2520F-1R0M), Skip Mode, Single Phase, F_{SW} = 1MHz, T_A = +25°C, unless otherwise noted.)

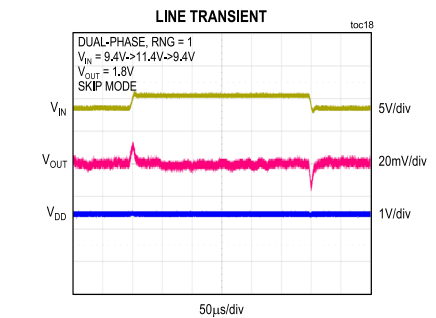
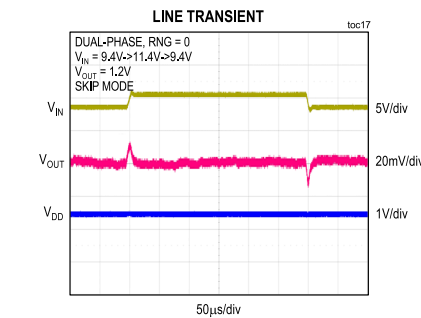
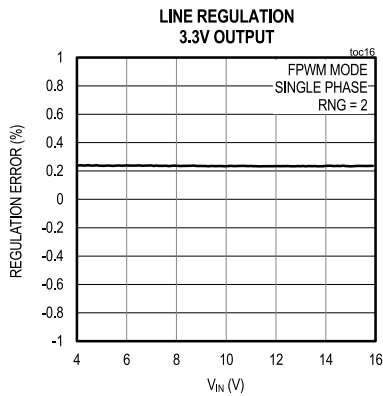
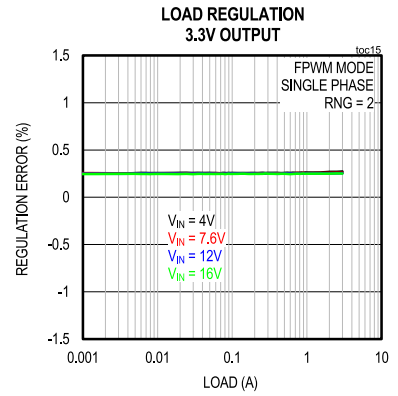
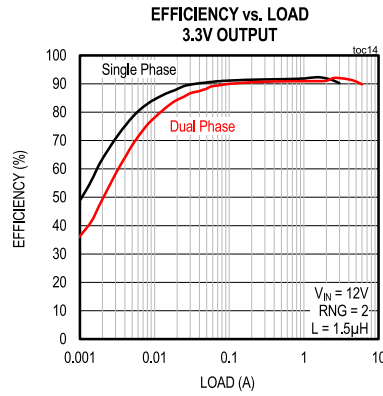
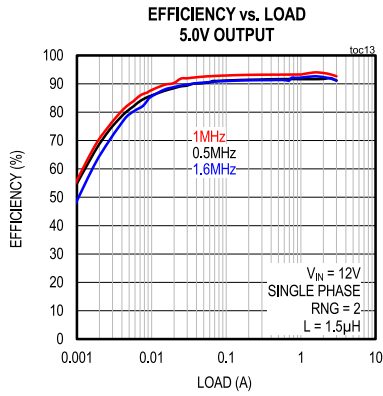
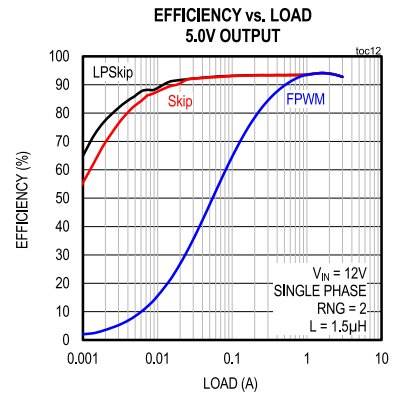
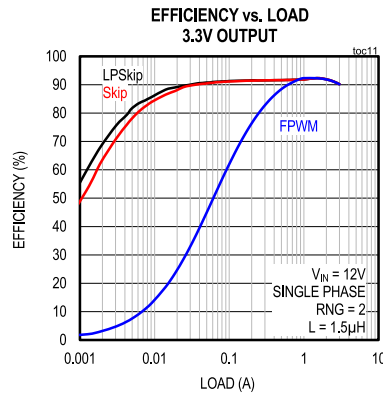
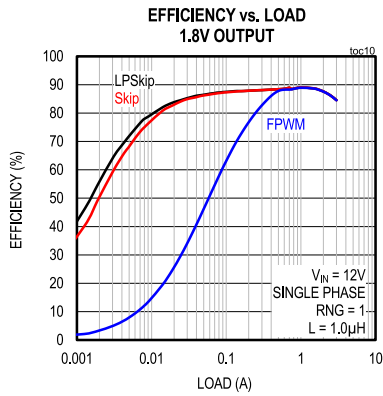

Typical Operating Characteristics (continued)

(V_{IN} = 12V, V_{OUT} = 3.3V, L = 1μH (Murata DFE2520F-1R0M), Skip Mode, Single Phase, F_{SW} = 1MHz, T_A = +25°C, unless otherwise noted.)

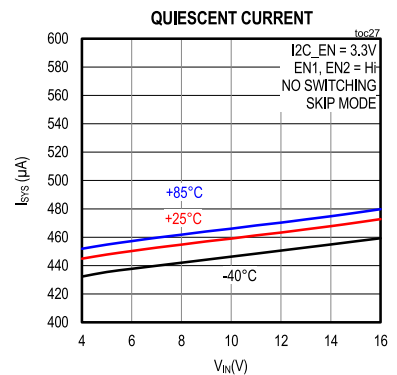
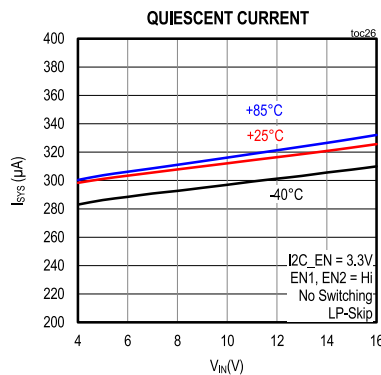
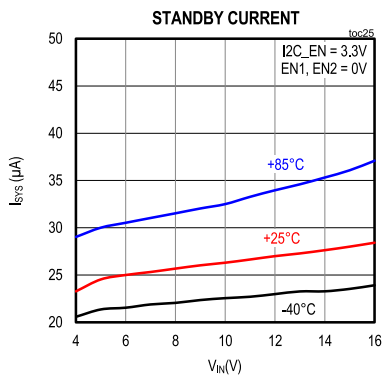
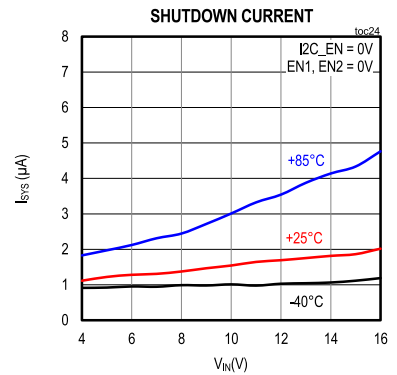
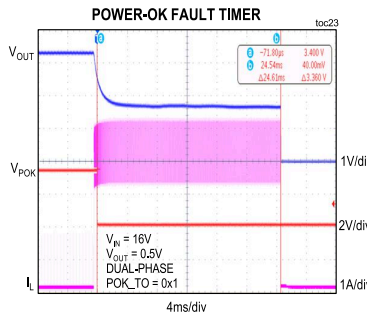
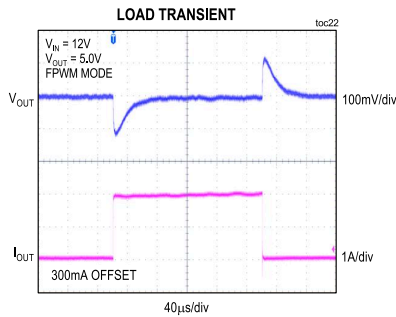
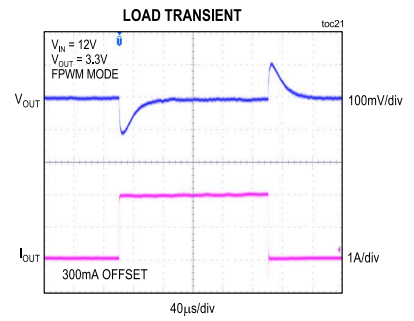
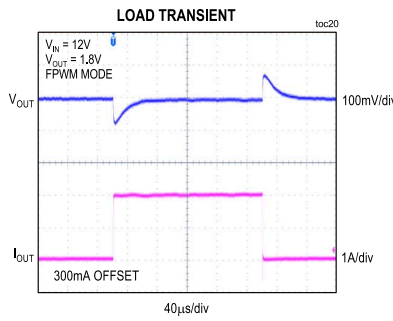
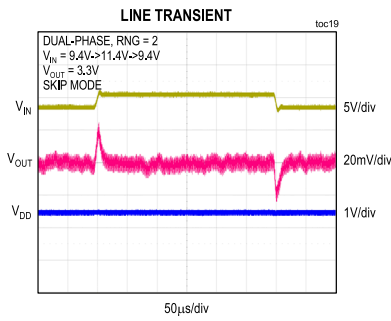

Typical Operating Characteristics (continued)

(V_{IN} = 12V, V_{OUT} = 3.3V, L = 1μH (Murata DFE2520F-1R0M), Skip Mode, Single Phase, F_{SW} = 1MHz, T_A = +25°C, unless otherwise noted.)

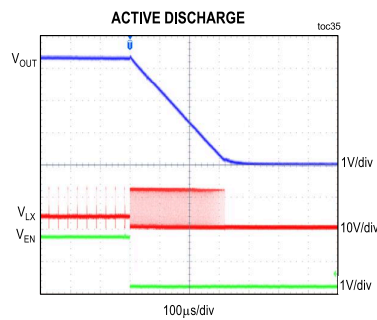
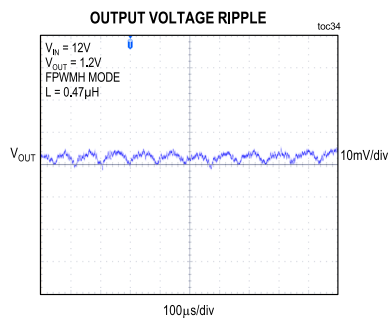
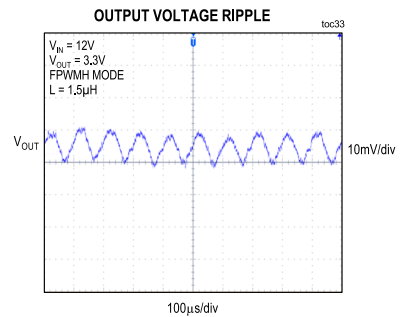
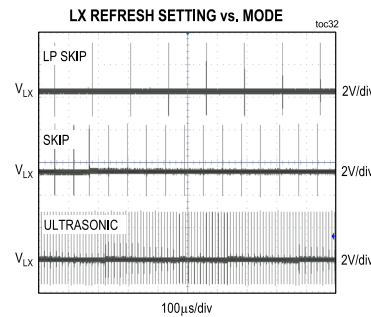
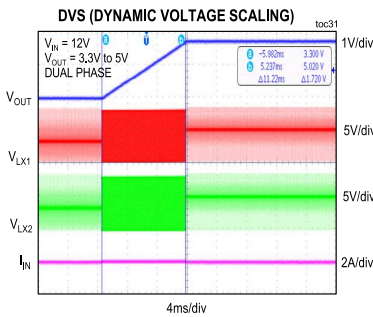
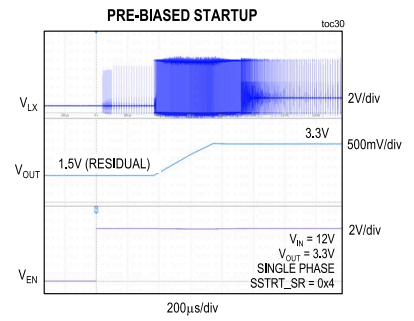
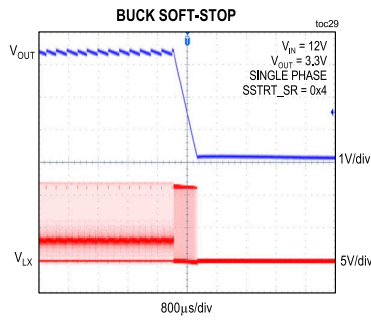
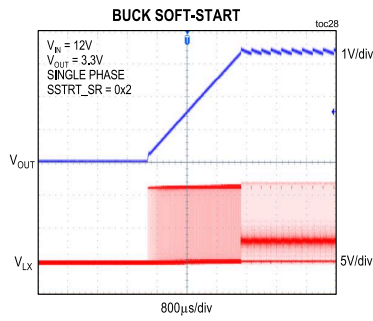

Bump Configuration

30 WLP

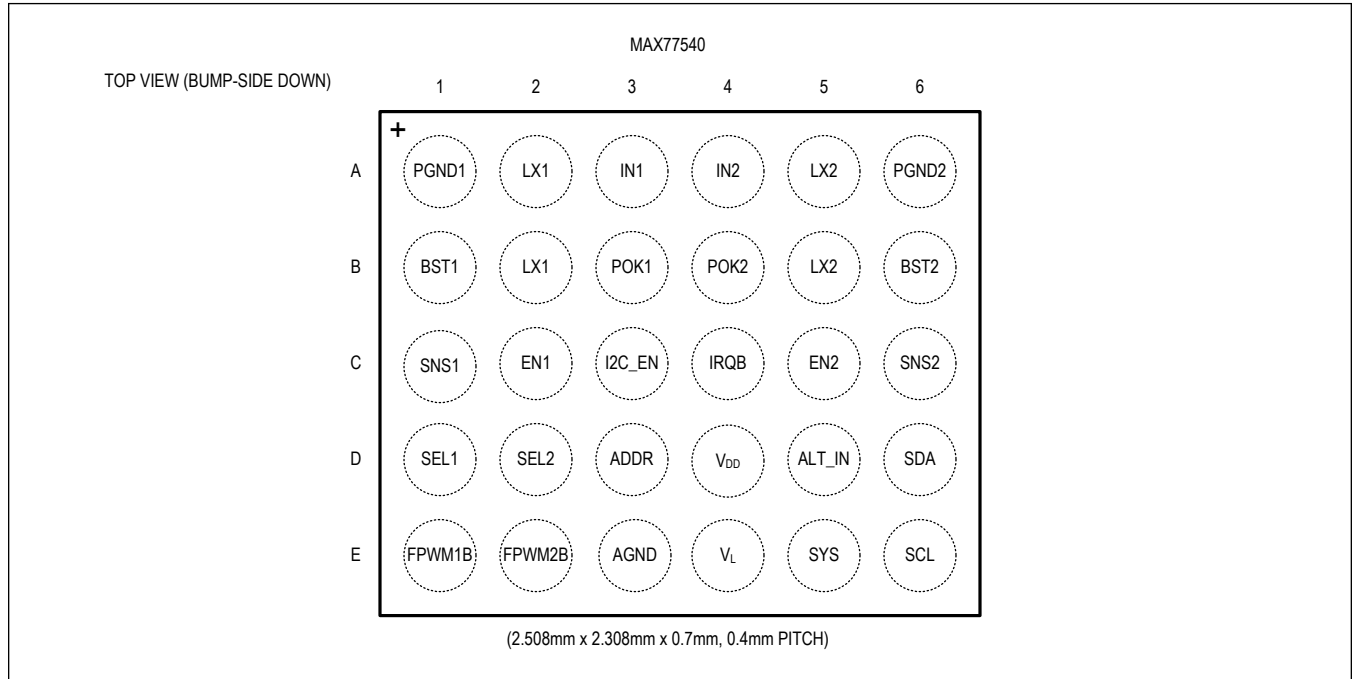

Bump Descriptions

| PIN | NAME | FUNCTION | TYPE |
|-----------------------------|-------|--|--------------|
| BUCK SWITCHING PHASE | | | |
| B1 | BST1 | Phase1 High-Side MOSFET Driver Supply. Connect a 0.1µF ceramic capacitor between BST1 and LX1. | Power Input |
| B6 | BST2 | Phase2 High-Side MOSFET Driver Supply. Connect a 0.1µF ceramic capacitor between BST2 and LX2. | Power Input |
| A3 | IN1 | Phase1 Input. Bypass to PGND1 with a 10µF ceramic capacitor. | Power Input |
| A4 | IN2 | Phase2 Input. Bypass to PGND2 with a 10µF ceramic capacitor. | Power Input |
| A2, B2 | LX1 | Phase1 Switching Node | Power Output |
| A5, B5 | LX2 | Phase2 Switching Node | Power Output |
| A1 | PGND1 | Phase1 Power Ground | Power Ground |
| A6 | PGND2 | Phase2 Power Ground | Power Ground |
| C1 | SNS1 | Phase1 Output Voltage Sensing Input. Connect to the output at the point-of-load. | Analog Input |
| C6 | SNS2 | Phase2 Output Voltage Sensing Input. Connect to the output at the point-of-load. Connect to AGND or leave unconnected (floating) when the phase configuration is set for 2Φ operation. | Analog Input |
| INTERNAL BIAS SUPPLY | | | |
| E3 | AGND | Analog (Quiet) Ground | Ground |

Bump Descriptions (continued)

| PIN | NAME | FUNCTION | TYPE |
|-------------------------------------|-----------------|--|----------------|
| D5 | ALT_IN | Alternative Power Input for V _L and V _{DD} . Bypass to AGND with a 2.2μF ceramic capacitor when used. See the Alternative Low-Voltage Input (ALT_IN) section for more information. | Power Input |
| E5 | SYS | System Power Input (Supply to Internal V _L and V _{DD} Linear Regulator). Bypass to AGND with a 2.2μF ceramic capacitor. | Power Input |
| D4 | V _{DD} | Internal Bias Supply Output. Powered from SYS or ALT_IN depending on V _{ALT_IN} . See the Alternative Low-Voltage Input (ALT_IN) section for more information. Bypass to AGND with a 1μF ceramic capacitor. Do not load this pin externally. | Power Output |
| E4 | V _L | Internal Gate Driver Supply Output. Powered from SYS or ALT_IN depending on V _{ALT_IN} . See the Alternative Low-Voltage Input (ALT_IN) section for more information. Bypass V _L to PGND with a 2.2μF ceramic capacitor. Do not load this pin externally. | Power Output |
| CONTROL AND SERIAL INTERFACE | | | |
| D3 | ADDR | I ² C Slave Address Selection Input (Tri-State). Connect to V _{DD} , ground, or leave unconnected to set I ² C slave address. See the Slave Address section for more information. | Digital Input |
| C2 | EN1 | Buck1 Enable Input (Active-High). V _{EN1} must not be higher than V _{SYS} . | Digital Input |
| C5 | EN2 | Buck2 Enable Input (Active-High). V _{EN2} must not be higher than V _{SYS} . This pin is a 'don't care' when the phase configuration is set for 2Φ operation. | Digital Input |
| E1 | FPWM1B | Buck1 Forced-PWM Mode Control (Active-Low) and External Frequency Tracking Input. Provide an external clock to enable FPWM mode with external frequency stabilization. Connect to V _L if unused. See the Frequency Tracking (FTRAK) section for more information. | Digital Input |
| E2 | FPWM2B | Buck2 Forced-PWM Mode Control (Active-Low) and External Frequency Tracking Input. Provide an external clock to enable FPWM mode with external frequency stabilization. Connect to V _L if unused. See the Frequency Tracking (FTRAK) section for more information. This input is a 'don't care' when the phase configuration is set for 2Φ operation. | Digital Input |
| C3 | I2C_EN | I ² C Enable Input (Active-High). Enables I ² C interface and V _L & V _{DD} regulators. V _{I2C_EN} must not be higher than V _{SYS} . See the Dedicated Internal Supplies section for more information. | Digital Input |
| C4 | IRQB | Interrupt Output (Open-Drain, Active-Low), This pin requires an external pullup resistor. Leave this pin unconnected if unused. | Digital Output |
| B3 | POK1 | Buck1 Power-OK Output (Open-Drain). An external pullup resistor (10kΩ to 100kΩ) is required. Leave this pin unconnected if unused. | Digital Output |
| B4 | POK2 | Buck2 Power-OK Output (Open-Drain). An external pullup resistor (10kΩ to 100kΩ) is required. Leave this pin unconnected if unused. This pin is pulled low internally when the phase configuration is set for 2Φ operation. | Digital Output |
| E6 | SCL | I ² C Serial Interface Clock. Connect to ground if not used. | Digital Input |
| D6 | SDA | I ² C Serial Interface Data. Connect to ground if not used. | Digital I/O |
| D1 | SEL1 | Buck1 Default V _{OUT} Selection Input. Connect a selection resistor (R _{SEL1}) between SEL1 and AGND to configure the default V _{OUT} , V _{OUT} range, and switching frequency for Buck1. Default settings can be overwritten through I ² C. See the Default Output Voltage Selection (SELx) section for more information. | Analog Input |

Bump Descriptions (continued)

| PIN | NAME | FUNCTION | TYPE |
|-----|------|---|--------------|
| D2 | SEL2 | Buck2 Default V _{OUT} Selection Input. Connect a selection resistor (R _{SEL2}) between SEL2 and AGND to configure the default target V _{OUT} , V _{OUT} range, and switching frequency, and range for Buck2. Default settings can be overwritten through I ² C. When R _{SEL2} ≤ 95.3Ω, Buck2 becomes a slave phase of a dual-phase converter. See the Default Output Voltage Selection (SELx) section for more information. | Analog Input |

Detailed Description—Top-Level

Dedicated Internal Supplies

The MAX77540 has dedicated internal supplies which are the V_L and the V_{DD}. The V_L provides power to gate drivers for switching metal-oxide semiconductor field-effect transistor (MOSFETs), while the V_{DD} provides power for internal logic and control. Those two 1.8V regulators are powered from either the SYS or the ALT_IN input, depending on the DIS_ALT_IN bit and the V_{ALT_IN}. See the [Alternative Low-Voltage Input \(ALT_IN\)](#) section for more information.

- The SYS powers the V_L and the V_{DD} when the DIS_ALT_IN == 1 **OR** the V_{ALT_IN} is less than the switch-over voltage (V_{SWO}, typ. 2.8V).
- The ALT_IN powers the V_L and the V_{DD} when the DIS_ALT_IN == 0 **AND** the V_{ALT_IN} is greater than the V_{SWO}.

When either the I2C_EN or the ENx pin is pulled high, the MAX77540 enables bias circuitry as well as V_L and V_{DD} supplies. As soon as the V_{DD} supply becomes stable, the MAX77540 reads the R_{SELx} values for configuring the device. While both the V_{SYS} and the V_{DD} are valid, I²C serial communication is activated. Enabling I²C by pulling the I2C_EN pin high allows the host processor to modify configuration settings before activating the Buck outputs.

Table 1. V_{DD} and I²C Enable Truth Table

| I2C_EN (PIN) | EN1 OR EN2 (PIN) | V _{DD} AND I ² C SERIAL INTERFACE |
|--------------|------------------|---|
| Low | Low | Disabled |
| X | High | Enabled |
| High | X | Enabled |

Alternative Low-Voltage Input (ALT_IN)

When an alternative power source (V_{ALT_IN}) is available between the switch-over voltage (V_{SWO}) and 5.5V, it can optionally be used to power the dedicated 1.8V linear regulator (V_L and V_{DD}) in order to improve the efficiency. As shown in [Figure 1](#), the switch-over circuit dynamically selects the input of the V_L and the V_{DD} supplies between the SYS and the ALT_IN pins as needed to maintain steady operation. When the device exits Shutdown mode (I2C_EN = 1 **OR** ENx = 1), the linear regulator is initially powered from the SYS pin and it can be switched over to the ALT_IN pin if a valid power source is connected to the ALT_IN. The ALT_IN_I interrupt and the ALT_SWO status bits indicate the status of the switch-over circuit. There are three ways of using the ALT_IN input:

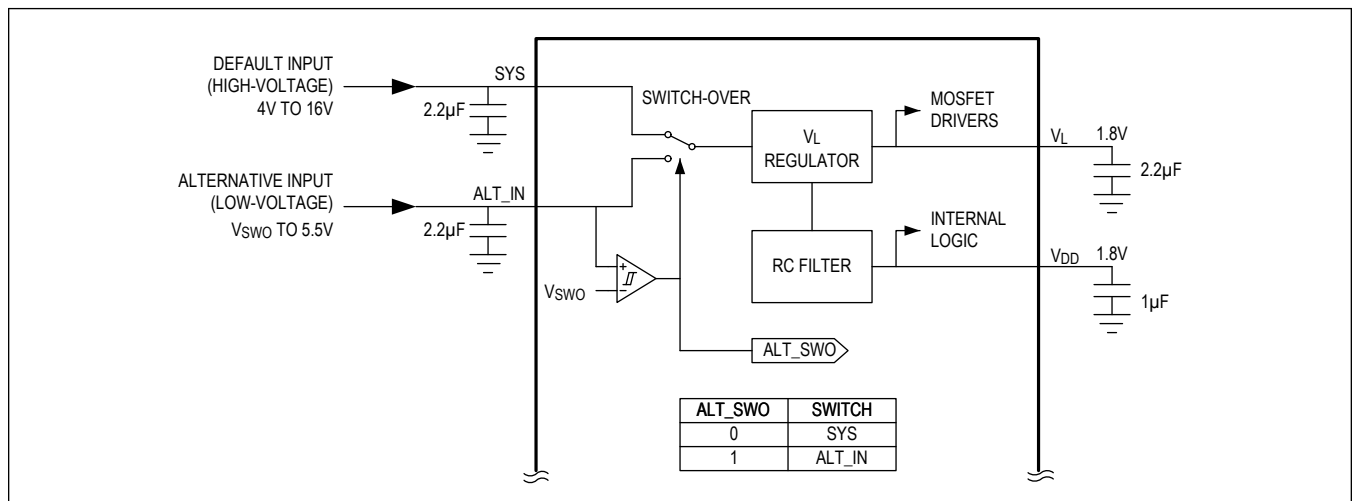

Figure 1. Alternative Input Switch-Over Circuit

- Option 1: Connect the ALT_IN pin to the AGND (not used). In this case, the internal linear regulator permanently receives power from the SYS pin.
- Option 2: Connect the ALT_IN pin to one of the Buck outputs which is greater than the V_{SWO}. Using a Buck output for powering up the linear regulator improves the total efficiency of the device (it is OK to turn the Buck output on and off dynamically).
- Option 3: Connect the ALT_IN pin to an external high-efficiency DC source greater than the V_{SWO} when neither Buck output is greater than the V_{SWO} (using a high-efficiency power source also improves the total system efficiency).

Output Enable Control

The MAX77540 has dedicated logic input pins (EN1 and EN2) for enabling individual Buck outputs. When the ENx is pulled above the V_{IH}, the corresponding Buck output is enabled. In case the MAX77540 exits Shutdown mode by the ENx, it takes about 220μs (typ) to turn on the internal bias circuitry and evaluate the R_{SELx} before propagating the Buck enable signals. To prevent chatter, the ENx pins must be driven either high or low.

The Buck outputs can also be turned on by setting the Mx_EN bits to '1' through the I²C serial interface. The logical interaction between the enable pins (ENx) and their corresponding I²C enable bits (Mx_EN) is 'OR'. The serial interface is active whenever the V_{DD} regulator is enabled (see [Table 1](#)).

Undervoltage Lockout

When the V_{SYS} voltage falls below the V_{UVLO_F} (typ 3.7V), the MAX77540 initiates an immediate shutdown of all individual Buck outputs. A UVLO event forces the device to a dormant state until the V_{SYS} voltage rises above the UVLO rising threshold (typ 3.9V). If the V_{SYS} voltage drops down to the power-on reset (POR) threshold (typ 1.7V), the V_{DD} supply turns off (all the registers are reset) and the MAX77540 enters into shutdown state.

Thermal Warnings and Thermal Shutdown (T_{SHDN})

The MAX77540 has two thermal warnings and a thermal shutdown (T_{SHDN}) threshold to monitor whether the junction temperature rises above +120°C and +140°C. As shown in [Figure 2](#), the device enters thermal shutdown (T_{SHDN}) if the junction temperature exceeds the T_{SHDN} (approximately +165°C typ.). A T_{SHDN} event initiates a shutdown of all individual outputs immediately. See the [Fault Protection](#) section for more information. Thermal monitoring is active whenever any of the following conditions is true:

- One of the Buck outputs is enabled.
- Force temperature monitors enable bit sets (EN_FTMON = 1).
- Thermal protection is enabled (for any reason) and detects T_J ≥ 120°C (in this case, thermal monitoring remains active until T_J ≤ 105°C).

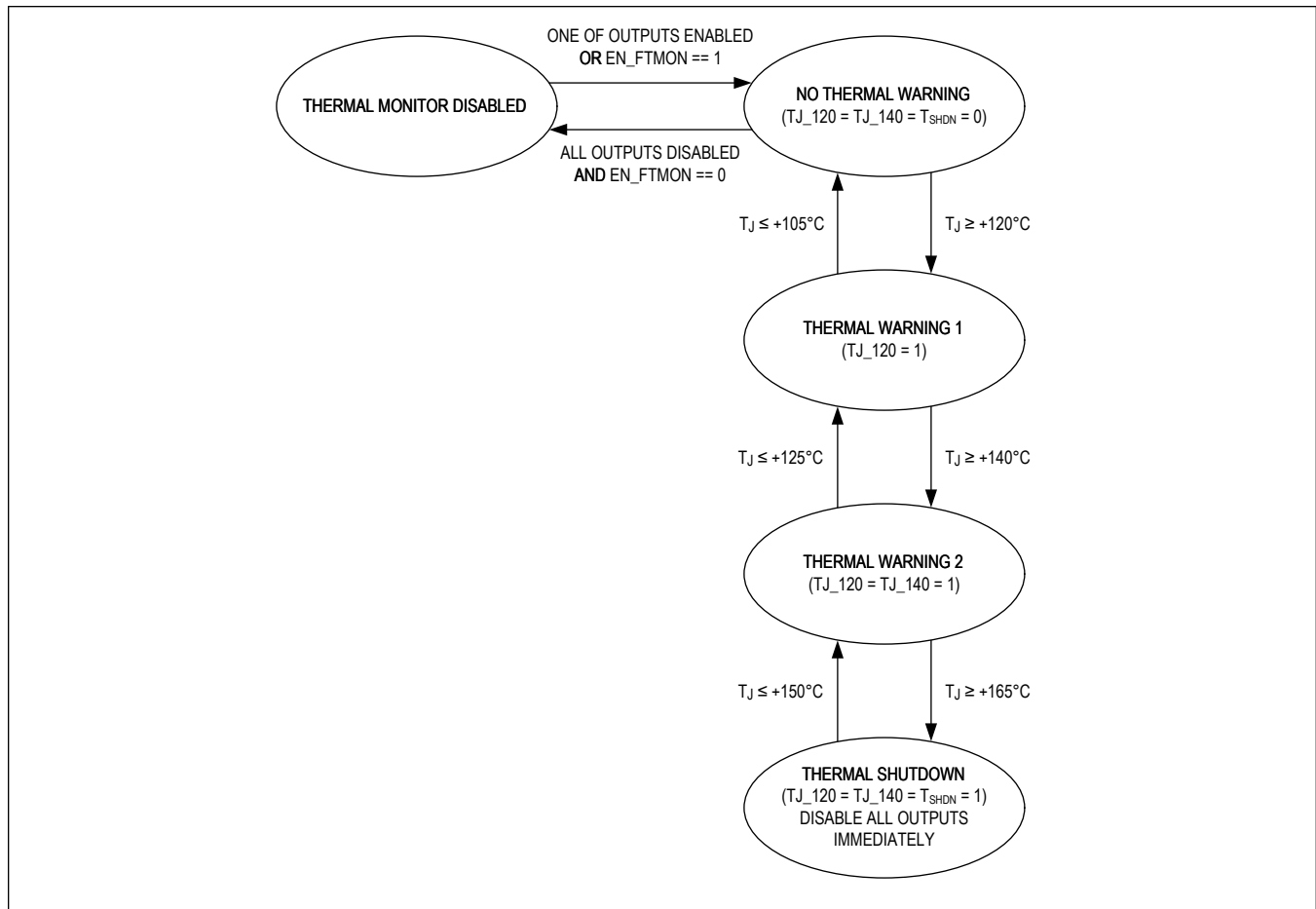

Figure 2. Thermal Monitor State Diagram

Interrupt (IRQB) and Mask

The IRQB is an active-low, open-drain output and it is for indicating to the host processor that the status on the MAX77540 has changed. The IRQB is the logical 'NOR' of all unmasked interrupt bits. See the [Register Map](#) for a full list of available status and interrupt bits.

The IRQB output asserts (goes low) anytime an unmasked interrupt bit is triggered. The host processor reads the interrupt source register (ADDR 0x00) and the interrupt registers that are indicated by the interrupt source register to check the cause of interrupt event. Note that the interrupt source register is cleared when the corresponding interrupt register group is read by the host processor.

All the interrupt events are edge-triggered. Therefore, the same interrupt is not generated repeatedly even though the interrupt condition persists.

Each interrupt register can be read at a time and all interrupt bits are 'Clear-on-Read' bits. The IRQB output deasserts (goes high) when all interrupt bits have been cleared. If an interrupt is captured during the read sequence, the IRQB output is held low. When the IRQB output is pulled low by an unmasked interrupt event, the IRQB output stays low until the interrupt bit is cleared by the reading operation of the host processor or the corresponding interrupt mask bit is set to '1' (masked). All interrupts (except the UVLO_I) are masked by default. Masked interrupt bits do not cause the IRQB pin to assert.

Register Reset Condition

The configuration registers of the device reset to default values when the I2C_EN, the EN1, and the EN2 are all logic low or the V_{SYS} falls below its POR threshold.

Detailed Description—Dual-Phase Configurable Buck Converter

The MAX77540 is a high-efficiency, phase-configurable Buck converter with two 3A phases (Φ). Two output voltage sensing inputs allow up to two regulated outputs. Each Buck converter operates on an input supply between 4V and 16V. The output voltages are preset using the SELx inputs and further configurable with an I²C serial interface between 0.5V and 5.2V in 5mV, 10mV, or 20mV steps depending on the Mx_RNG[1:0] bits. See the [Output Voltage Setting](#) section.

Each switching phase supports 3A and dual-phase (2Φ) configuration supports up to 6A. Phase configuration is user-programmable by tying the SEL2 pin to the AGND on the PCB. See the [Phase Configuration](#) section.

Buck Converter Control Scheme

The MAX77540 uses Maxim's proprietary adaptive constant on-time (COT) current-mode control scheme. The adaptive COT control provides fast response to load transients, inherent compensation to input voltage variation, and stable performance at low duty cycles. As shown in [Figure 3](#), Buck1 is referenced in the following explanation.

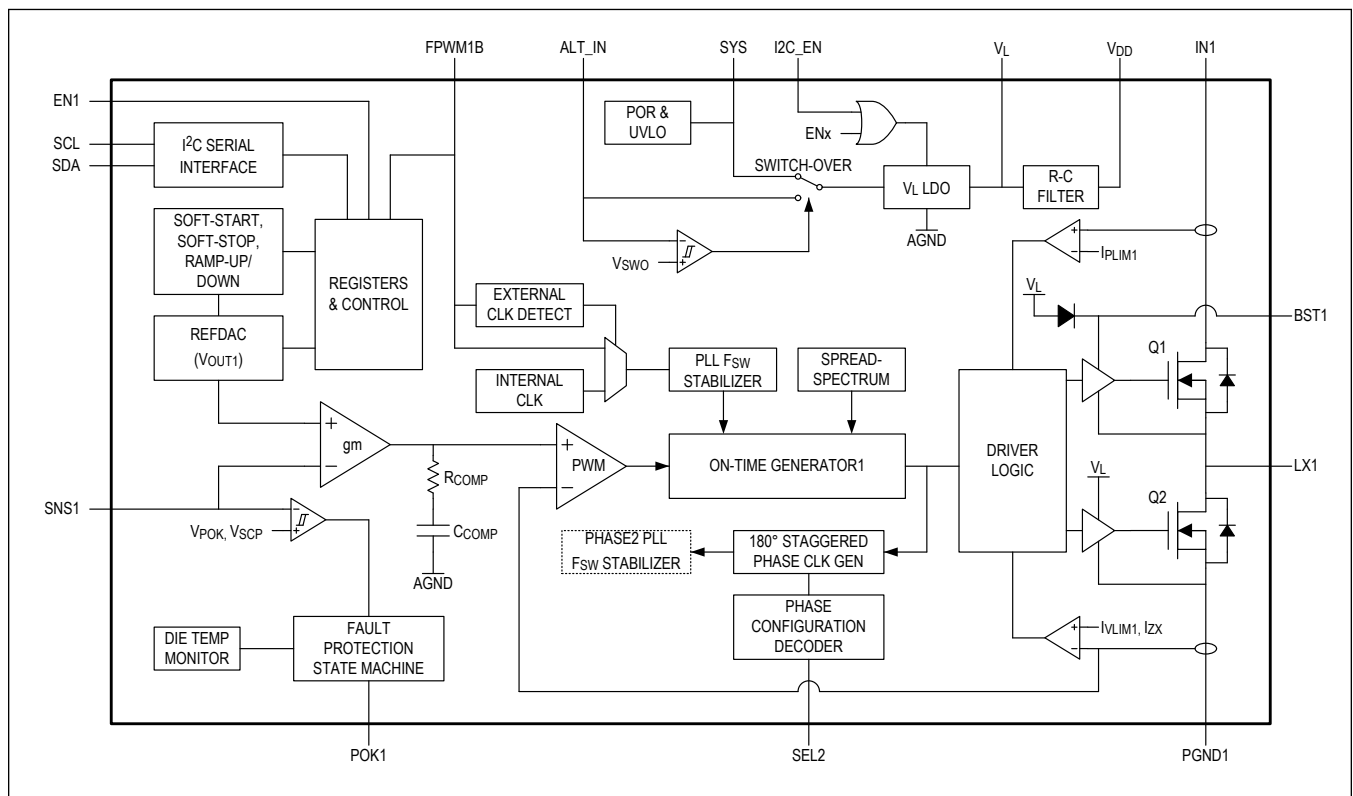

Figure 3. Functional Block Diagram

An on-time (MOSFET Q1 is on) is controlled by an on-time generator circuit and this circuit calculates an on-time based on the input voltage (V_{IN1}), the output voltage (V_{OUT1}), and the target switching frequency (F_{SW1}). An off-time (MOSFET Q2 is on) begins when the on-time ends. During the dead-time, the inductor current conducts through the intrinsic body diode. A pulse-width modulation (PWM) comparator regulates the V_{OUT1} by modulating off-time. The positive input of the PWM comparator is a voltage proportional to the actual output voltage error. The negative input is a voltage proportional to the inductor current sensed through the MOSFET Q2. The PWM comparator begins an on-time when the error voltage

becomes higher than the current-sense signal. The off-time automatically begins again when the calculated on-time expires. A phase-locked loop (PLL) stabilizes the switching frequency and controls phase spacing. The PLL stabilizes Phase2 (LX2) 180° apart from Phase1 when the output is configured for the dual-phase (2Φ) operation. In dual-phase configuration, both the master and the slave phases are activated and always switch in sequence during steady-state operation. The phases do not add or shed.

Buck Operating Modes

The buck converters have three operating modes shown in [Figure 4](#) and transitions between the modes are determined by operating conditions and mode control settings. The operating mode setting can be changed any time while I²C communication is available. Toggling between SKIP and FPWM modes is also controlled by the FPWMxB pins. Pulling the FPWMxB pin low operates the corresponding buck in forced-PWM mode. When the FPWMxB pin is held high, the operating mode is controlled by the Mx_LPM and the Mx_FPWM bits.

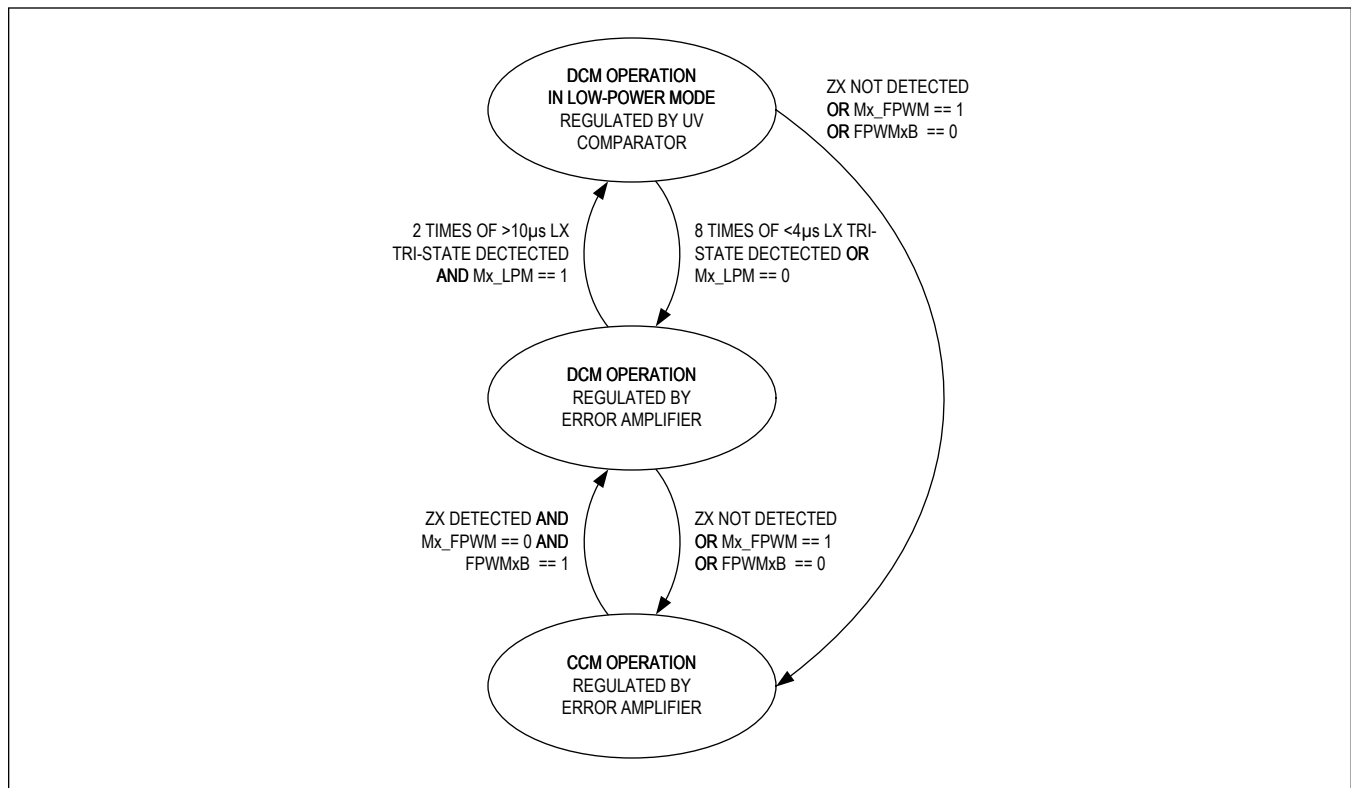

Figure 4. Buck Operating Modes

Detail mode control settings are described as follows:

SKIP Mode

In SKIP mode ($Mx_LPM == Mx_FPWM == 0$ AND $FPWMxB == 1$), the buck converter operates either in discontinuous-conduction mode (DCM) or continuous-conduction mode (CCM) depending on loading. If the averaged output current is lower than a half of inductor peak-to-peak ripple current under light load condition, the low-side MOSFET turns off as soon as the inductor current drops to near zero ampere (zero-crossing). Then, the switching node (LX) remains in tri-state (Hi-Z) until the next on-time is triggered. In this way, the buck prevents a negative inductor current which results in improving light-load efficiency by reducing the total number of switching cycles needed to regulate the output voltage.

When no zero-crossing (ZX) is detected (under heavier load), the buck controller goes into CCM where the averaged output current is greater than a half of inductor ripple current. In both DCM and CCM, the output voltage is regulated by an

error amplifier. In case the on-time determined by a given operating condition in high output voltage range ($Mx_RNG[1:0] = 0x2$) is not long enough, the on-time automatically extends until the inductor current reaches 500mA for ensuring enough off-time to detect the ZX reliably.

Low-Power SKIP (LP-SKIP) Mode

Low-Power SKIP mode ($Mx_LPM == FPWMxB == 1$ **AND** $Mx_FPWM == 0$) is similar to SKIP mode as a negative inductor current is not allowed in LP-SKIP mode as well. When the averaged output current is decreased further down ($>10\mu s$ of LX tri-state is detected two times consecutively) in SKIP mode, the buck converter enters LP-SKIP mode when Low Power mode is enabled. In LP-SKIP mode, the error amplifier and other internal blocks are deactivated to lower down I_Q consumption. Instead, a low-power comparator monitors the output voltage in LP-SKIP mode.

The Buck enters DCM operation in SKIP mode when the duration of LX tri-state is shorter than $4\mu s$ for eight times in a row, or LP-SKIP mode is disabled ($Mx_LPM == 0$). If no zero-crossing is detected (i.e., sudden load transient) or FPWM mode is enabled ($Mx_FPWM = 1$ **OR** $FPWMxB = 0$), the Buck enters CCM directly from LP-SKIP mode.

Forced-PWM (FPWM) Mode

Forced-PWM mode ($Mx_FPWM == 1$ **OR** $FPWMxB == 0$) ensures a continuous inductor current under all load conditions. In FPWM mode, a negative inductor current through the low-side MOSFET is allowed but the maximum current is limited to the I_{NLM} (typ -2.9A). When the buck converters enter/exit FPWM mode by the FPWMxB inputs, there is 1ms of delay in mode transition due to 1ms of debounce timer on the FPWMxB inputs.

In case a valid external frequency is detected on the FPWMxB input, the corresponding Buck enters FPWM mode regardless of its operating mode settings. See the [Frequency Tracking \(FTRAK\)](#) section for more information.

Dropout Mode

The MAX77540 architecture allows the buck converter to operate even when the input voltage becomes very close to the target output voltage. When the headroom between the input and the output voltages reduces during operation, the buck controller tries to maintain the output voltage regulation by increasing the duty cycle. In case Buck is not able to regulate the target output voltage with the maximum duty cycle (typ 98%), it automatically extends the on-time by skipping the off-times (dropout mode). In dropout mode, the low-side MOSFET turns on occasionally in order to refresh the bootstrap circuit for driving the high-side MOSFET. See the [Bootstrap Refresh](#) section for more information.

Switching Frequency

The MAX77540 has three nominal switching frequency options (0.5MHz, 1.0MHz, and 1.6MHz) to support optimization of efficiency, transient responses, noise performance, and solution size. The default switching frequency of each Buck is set by the SELx input (see [Table 4](#) and [Table 5](#)) and the switching frequencies of individual Bucks are also selectable by the $Mx_FREQ[1:0]$ bits.

At a particular time, the switching frequency (F_{SW}) of the adaptive on-time buck converter is not fixed and heavily influenced by the instantaneous load current. More on-time pulses in a given time (higher F_{SW}) is observed as the output current increases, while fewer on-times in a given time (lower F_{SW}) is observed when the output current decreases. A valid external frequency at the FPWMxB input or enabling the internal frequency tracking feature ($Mx_FTRAK = 1$) stabilizes the switching frequency of the corresponding Buck in steady-state operation. See the [Frequency Tracking \(FTRAK\)](#) section for more information.

In case the on-time calculated by the given operating condition is less than the minimum on-time (typ 60ns), the buck controller regulates the output voltage by increasing the off-time. As a result, the actual switching frequency becomes slower than its nominal frequency setting. For example, the calculated duty cycle for 16V_{IN} and 0.8V_{OUT} is 5%, which gives less than 60ns of on-time at 1.0MHz of nominal switching frequency. It means the actual switching frequency under this condition is slower than 1.0MHz so that 0.5MHz of nominal switching frequency setting is recommended.

Phase Configuration

The MAX77540 has two 3A switching phases configurable into either two single-phase Bucks or one dual-phase Buck. As shown in [Table 2](#), the Buck is configured as single-output dual-phase (2Φ) when the SEL2 is shorted to the AGND. In

dual-phase (2Φ) configuration, logic I/O pins and control registers for Buck2 are deactivated so that register settings of the master phase (M1) dictate the operation of the slave phase as well.

Table 2. Phase Configuration Selection

| R _{SEL1} (Ω) | R _{SEL2} (Ω) | PHASE (Φ) CONFIGURATION | NUMBER OF OUTPUTS |
|-----------------------|-----------------------|-------------------------|-------------------|
| Any | ≤ 95.3 | 2Φ | 1 |
| Any | ≥ 200 | 1Φ + 1Φ | 2 |

Also, the output voltage sensing of the buck converter is assigned based on the phase configuration setting. In dual-phase configuration, the buck controller regulates the output voltage using the SNS1 pin only (the SNS2 pin is unused). [Table 3](#) shows how to configure the output voltage sensing pins for each phase configuration.

Table 3. Buck Output Sensing Assignment

| PHASE (Φ) CONFIGURATION | PHASE ASSIGNED | BUCK NAMING CONVENTION | V _{OUT} SENSING INPUT |
|-------------------------|---------------------------|----------------------------|--------------------------------|
| 2Φ (1 Output) | Phase1 (M1) Phase2 (S) | Buck1 (V _{OUT1}) | SNS1 |
| 1Φ + 1Φ (2 Outputs) | Phase1 (M1) | Buck1 (V _{OUT1}) | SNS1 |
| | Phase2 (M2) | Buck2 (V _{OUT2}) | SNS2 |

(Mx): Master Phase (S): Slave Phase

Default Output Voltage Selection (SELx)

The MAX77540 supports user-selectable default voltages of individual Buck outputs with 1% tolerance (or better) resistors. The MAX77540 evaluates the resistances between the SELx and the AGND whenever the V_{DD} regulator first turns on (exits shutdown by either the I2C_EN or the ENx pin). The decoded values of the R_{SELx} are latched until the next time the device exits shutdown mode. The SELx_LATCH[4:0] status bits reflect the latched decoded values of the R_{SELx}. See the [Register Map](#) for more details.

The resistance between the SEL1 and the AGND (R_{SEL1}) configures the default voltage of Buck1, while the R_{SEL2} between the SEL2 and the AGND selects Buck2 default voltage. If the SEL2 pin is tied to the AGND on the PCB (R_{SEL2} ≤ 95.3Ω), the Buck is configured as a single-output dual-phase (2Φ) converter. When the dual-phase operation is selected, the decoded resistance on the SEL1 (R_{SEL1}) sets the default output voltage (V_{OUT1}). [Table 4](#) and [Table 5](#) decode the default selection options for the V_{OUT1} and the V_{OUT2}, respectively. Once latched, the Mx_VOUT[7:0], the Mx_RNG[1:0], and the Mx_FREQ[1:0] bits reflect the selected options. The decoded values for R_{SELx} ≥ 115kΩ are programmable at the factory.

Table 4. Default V_{OUT1} Selection

| R _{SEL1} (Ω) | TARGET V _{OUT1} (V) | V _{OUT1} RANGE | F _{sw1} (MHz) |
|-----------------------|------------------------------|-------------------------|------------------------|
| ≤ 95.3 | 0.50 | Low | 1 |
| 200 | 0.50 | Low | 0.5 |
| 309 | 0.60 | Low | 0.5 |
| 422 | 0.60 | Low | 1 |
| 536 | 0.65 | Low | 0.5 |
| 649 | 0.65 | Low | 1 |
| 768 | 0.72 | Low | 0.5 |
| 909 | 0.72 | Low | 1 |
| 1.05k | 0.75 | Low | 0.5 |
| 1.21k | 0.75 | Low | 1 |
| 1.40k | 0.80 | Low | 0.5 |
| 1.62k | 0.80 | Low | 1 |

Table 4. Default V_{OUT1} Selection (continued)

| R _{SEL1} (Ω) | TARGET V _{OUT1} (V) | V _{OUT1} RANGE | F _{SW1} (MHz) |
|-----------------------|------------------------------|-------------------------|------------------------|
| 1.87k | 0.85 | Low | 0.5 |
| 2.15k | 0.85 | Low | 1 |
| 2.49k | 0.90 | Low | 0.5 |
| 2.87k | 0.90 | Low | 1 |
| 3.74k | 1.00 | Low | 0.5 |
| 8.06k | 1.00 | Mid | 1 |
| 12.4k | 1.10 | Low | 0.5 |
| 16.9k | 1.10 | Mid | 1 |
| 21.5k | 1.20 | Low | 0.5 |
| 26.1k | 1.20 | Mid | 1 |
| 30.9k | 1.35 | Mid | 1 |
| 36.5k | 1.50 | Mid | 1 |
| 42.2k | 1.80 | Mid | 1 |
| 48.7k | 2.00 | Mid | 1 |
| 56.2k | 2.50 | High | 1 |
| 64.9k | 2.80 | High | 1 |
| 75.0k | 3.30 | High | 1 |
| 86.6k | 3.80 | High | 1 |
| 100k | 5.00 | High | 1 |
| ≥ 115k | Factory Option | | |

Table 5. Default V_{OUT2} Selection

| R _{SEL2} (Ω) | TARGET V _{OUT2} (V) | V _{OUT2} RANGE | F _{SW2} (MHz) |
|-----------------------|------------------------------|-------------------------|------------------------|
| ≤ 95.3 | N/A (2Φ Operation) | | |
| 200 | 0.50 | Low | 0.5 |
| 309 | 0.60 | Low | 0.5 |
| 422 | 0.60 | Low | 1 |
| 536 | 0.65 | Low | 0.5 |
| 649 | 0.65 | Low | 1 |
| 768 | 0.72 | Low | 0.5 |
| 909 | 0.72 | Low | 1 |
| 1.05k | 0.75 | Low | 0.5 |
| 1.21k | 0.75 | Low | 1 |
| 1.40k | 0.80 | Low | 0.5 |
| 1.62k | 0.80 | Low | 1 |
| 1.87k | 0.85 | Low | 0.5 |
| 2.15k | 0.85 | Low | 1 |
| 2.49k | 0.90 | Low | 0.5 |
| 2.87k | 0.90 | Low | 1 |
| 3.74k | 1.00 | Low | 0.5 |

Table 5. Default V_{OUT2} Selection (continued)

| R _{SEL2} (Ω) | TARGET V _{OUT2} (V) | V _{OUT2} RANGE | F _{sw2} (MHz) |
|-----------------------|------------------------------|-------------------------|------------------------|
| 8.06k | 1.00 | Mid | 1 |
| 12.4k | 1.10 | Low | 0.5 |
| 16.9k | 1.10 | Mid | 1 |
| 21.5k | 1.20 | Low | 0.5 |
| 26.1k | 1.20 | Mid | 1 |
| 30.9k | 1.35 | Mid | 1 |
| 36.5k | 1.50 | Mid | 1 |
| 42.2k | 1.80 | Mid | 1 |
| 48.7k | 2.00 | Mid | 1 |
| 56.2k | 2.50 | High | 1 |
| 64.9k | 2.80 | High | 1 |
| 75.0k | 3.30 | High | 1 |
| 86.6k | 3.80 | High | 1 |
| 100k | 5.00 | High | 1 |
| ≥ 115k | Factory Option | | |

Output Voltage Setting

The output voltages (V_{OUTx}) are adjustable between 0.5V and 5.2V in 5mV, 10mV, or 20mV steps depending on the Mx_RNG[1:0] bits as shown in [Table 6](#). Note that the Mx_RNG[1:0] bits must not be changed while the corresponding Buck is enabled.

In each output voltage range, the lowest code (0x00) of the Mx_VOUT[7:0] bits represents the minimum output voltage and the target output voltage is increased by one least significant bit (LSB) step as the code increases. The maximum programmable output voltage is digitally limited to the maximum output voltage in each range even if the code increases beyond that point. The default values of the Mx_VOUT[7:0] and the Mx_RNG[1:0] bits are set by the corresponding R_{SELx} values. See the [Default Output Voltage Selection \(SELx\)](#) section for more information.

For output voltages that have overlapping ranges (i.e., 1.0V), select the desired range by trading off load transient response and the required number of output capacitors. Using the 1V output example: Use low-range for a slightly better load transient response or mid-range for a slightly worse transient response but less output capacitors. See the [Output Capacitor Selection](#) section for more information on required output capacitance for the different output voltage ranges.

Table 6. Buck Output Voltage Range

| Mx_RNG[1:0] | V _{OUT} PROGRAMMING RANGE (V) | STEP PER LSB (mV) |
|------------------|--|-------------------|
| 0x0 (Low-range) | 0.5 to 1.2 | 5 |
| 0x1 (Mid-range) | 1.0 to 2.4 | 10 |
| 0x2 (High-range) | 2.0 to 5.2 | 20 |

Soft-Start and Soft-Stop

The Bucks always soft-start whenever they are enabled (regardless of the ENx or I²C command) or recovering from a fault condition. When the individual Buck is disabled by the ENx or I²C command, the Buck always initiates soft-stop. If an SCP event occurs to a Buck output, the corresponding Buck stops switching immediately (LX node becomes Hi-Z) and the other Buck starts soft-stop in a controlled manner if enabled. For a T_{SHDN} fault event, all Bucks stop switching immediately.

The Bucks have internal ramps that control the slew rate of output voltage changes during the soft-start and the soft-stop. The soft-start and the soft-stop slew rates are individually set by the SSTRT_SR[2:0] and the SSTOP_SR[2:0]

bits, respectively, and they are the global settings for all Buck phases. During the soft-start and soft-stop, the Buck automatically enters the FPWM mode regardless of operating mode settings when the Mx_FSREN bit is set to '1' (default). To support the 'prebiased' startup (startup without discharging pre-existing voltage at the output), the Mx_FSREN and the Mx_ADIS100 bits need to be set to '0' before the Buck is enabled.

The SSTRT_SR[2:0] and the SSTOP_SR[2:0] bits set the slew rates of a voltage reference to an error amplifier. When the fastest slew-rate option is selected, the actual output voltage slew rate can be slower than the target setting due to limited sourcing and the sinking current capabilities of Bucks under given circuit parameters and operating conditions. See [Table 7](#) for more information.

Dynamic Output Voltage Scaling

Whenever a new target value is written in the Mx_VOUT[7:0] bits through I²C while the corresponding Buck is enabled, the output voltage starts to change. The output voltage ramps up (or down) at a positive (or negative) slew rate set by the corresponding Mx_RU_SR[2:0] (or Mx_RD_SR[2:0]) bits. When the Mx_FSREN bit is set, the corresponding Buck enters FPWM mode automatically (regardless of the Mx_FPWM bit) during the output voltage ramp-down. In FPWM mode, the Buck can sink current from the C_{OUTx} to the PGNDx through the low-side MOSFET, which allows the V_{OUTx} to track the negative rate set by the Mx_RD_SR[2:0] bits.

Table 7. Mx_FSREN Effect on Buck Behavior

| OPERATING MODE | Mx_FSREN | BUCK BEHAVIOR IN STEADY STATE | BUCK BEHAVIOR DURING DVS |
|-----------------|----------|-------------------------------|--------------------------|
| SKIP or LP-SKIP | 0 | Source Only | Source Only |
| | 1 | Source Only | Source or Sink |
| FPWM | X | Source or Sink | Source or Sink |

Note: Buck outputs (V_{OUTx}) with current sinking capability can follow negative ramp rates set by the Mx_RD_SR[2:0] or the SSTOP_SR[2:0].

If the negative inductor current reaches the I_{NLIM} (typ -2.9A), the low-side MOSFET is turned off immediately and the Buck initiates a new on-time (high-side MOSFET turn-on). Thus, the maximum slew rate during output voltage ramp-down (or soft-stop) is limited if an effective output capacitance is very high for the selected ramp-down (or soft-stop) slew rate. The maximum output voltage slew rate is calculated by following the formula, $dV_C/dt = i_C / C$.

Output Voltage Active Discharge

Each Buck converter integrates a 100Ω active discharge resistor between the LXx and the PGNDx for discharging the output capacitor when the Buck output is disabled. For faster output voltage discharge at the end of soft-stop, a 1Ω active discharge function is added. Those two active discharge resistors are individually enabled by setting the Mx_ADIS100 and the Mx_ADIS1 bits, respectively. If both the Mx_ADIS100 and the Mx_ADIS1 are set to '1', the 1Ω active discharge is first activated for 1ms right after soft-stop is completed, and then the 100Ω active discharge is enabled until the Buck is enabled next time. In shutdown mode (I2C_EN = EN1 = EN2 = 0), the 100Ω active discharge of each Buck phase is enabled by default.

Note that the 1Ω active discharge function of the corresponding output must be disabled (Mx_ADIS1 = 0) to avoid excessive power dissipation when the falling slew-rate control feature is disabled (Mx_FSREN = 0).

Bootstrap Refresh

When the Buck is in dropout operation or it operates in SKIP (or LP-SKIP) mode under extremely light load condition, the low-side MOSFET does not turn on for a long period of time. In this case, the buck controller occasionally turns on the low-side MOSFET for about 100ns (typ) in order to charge a bootstrap circuit for driving the high-side MOSFET. The bootstrap refresh interval is set to 64μs in SKIP mode (128μs in LP-SKIP) which gives 15.6kHz (7.8kHz) of minimum switching frequency. For applications that audible range noises are critical, 'Ultrasonic' mode (Mx_ULTRA == 1) increases the minimum switching frequency to 100kHz by reducing the refresh interval to 10μs. The bootstrap refresh interval selection is shown in [Table 8](#).

Table 8. Bootstrap Refresh Interval Selection

| Mx_ULTRA | REFRESH INTERVAL | |
|----------|---------------------------|-------------------|
| | SKIP OR DROPOUT MODE (μs) | LP-SKIP MODE (μs) |
| 0 | 64 | 128 |
| 1 | 10 | 10 |

The bootstrap refresh is also required when the buck converter starts switching. As a part of the startup procedure, the buck controller forces 15 times of refresh pulses with 4μs of interval.

Frequency Tracking (FTRAK)

The MAX77540 supports frequency tracking feature. When a valid external clock is detected on the FPWMxB input (triggers the EXT_FREQ_DET_I interrupt if unmasked), the corresponding buck converter enters FPWM mode regardless of its operating mode setting and tracks the external frequency by modulating on-times. Buck1 attempts to track the beginning of on-times to the rising edges of the external clock on the FPWM1B input, while Buck2 attempts to track the beginning of on-times to the falling edges of the external clock on the FPWM2B input.

Table 9. Mx_FTRAK Enable Truth Table

| EXT_FREQ_DET | Mx_FTRAK | PLL | BUCK OPERATING MODE | NOTE |
|--------------|----------|----------|------------------------------|-------------------------|
| 0 | 0 | Disabled | Depends on Buck Mode Setting | No Tracking |
| 0 | 1 | Enabled | Depends on Buck Mode Setting | Internal Freq. Tracking |
| 1 | 0 | Enabled | FPWM | External Freq. Tracking |
| 1 | 1 | Enabled | FPWM | External Freq. Tracking |

As shown in [Table 9](#), the Bucks can also track an internal clock. When the FTRAK function is enabled (Mx_FTRAK = 1), the corresponding Buck tracks the internal PLL frequency (set by the Mx_FREQ[1:0] bits) if no valid external clock is applied. In case a valid external clock is detected while the corresponding Buck is tracking the internal PLL, it switches to the external clock tracking. The frequency window for both external and internal tracking is about ±5% of the nominal switching frequency. The frequency tracking operation is legal whenever one of the buck converters is enabled regardless of the I2C_EN pin status. The FPWM1B and the FPWM2B must be driven either low or high to prevent chattering or false tracking.

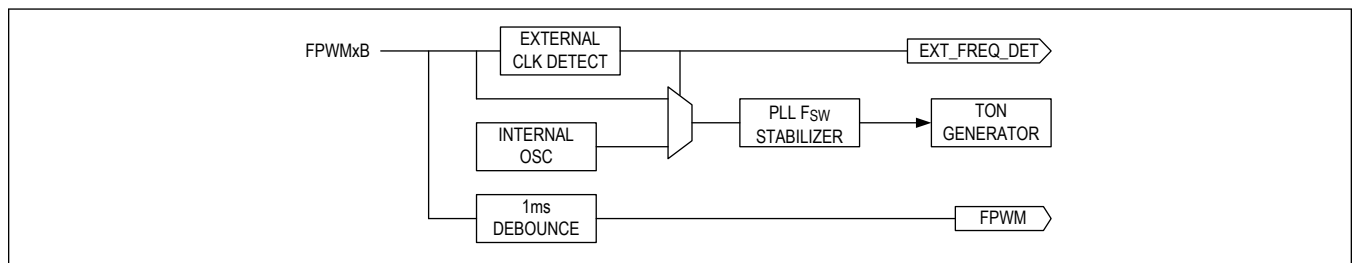

Figure 5. Frequency Tracking

Spread-Spectrum Modulation

The Bucks are capable of dithering their switching frequency for noise-sensitive applications. The spread-spectrum function of each Buck is individually enabled by setting the Mx_SS_ENV[1:0] bits. The spread-spectrum function is activated only in the CCM and it is automatically deactivated when the Bucks enter the DCM. The spread-spectrum modulation pattern is programmable either pseudorandom or triangular by the Mx_SS_PAT[1:0] bits. The spread-spectrum modulation is characterized by modulation envelope and modulation frequency:

- Modulation envelope (ΔF_{SS}) determines the maximum difference between the modulated switching frequency and the nominal switching frequency. The modulation envelope is programmable (±8%, ±12%, or ±16%) by the Mx_SS_ENV[1:0] bits and it controls 'how wide' the switching frequency dithers.

- Modulation frequency (F_{SS_MOD}) determines how often the switching frequency changes from one value to another. The modulation frequency is also programmable (1kHz, 3kHz, 5kHz, or 7kHz) by the $Mx_SS_FREQ[1:0]$ bits and it controls 'how fast' the switching frequency dithers.

Pseudo-Random Pattern

The pseudo-random engine uses a 4-bit linear feedback shift register (LFSR) to create a pseudo-random value as shown in Figure 6. The LFSR value is converted to an analog signal and then amplified before being added to the output of the on-time generator circuit. The pseudo-random value shortens or lengthens the on-time. This causes the Buck controller to increase or decrease the switching frequency to maintain voltage regulation. Each Buck has its own pseudo-random pattern generator.

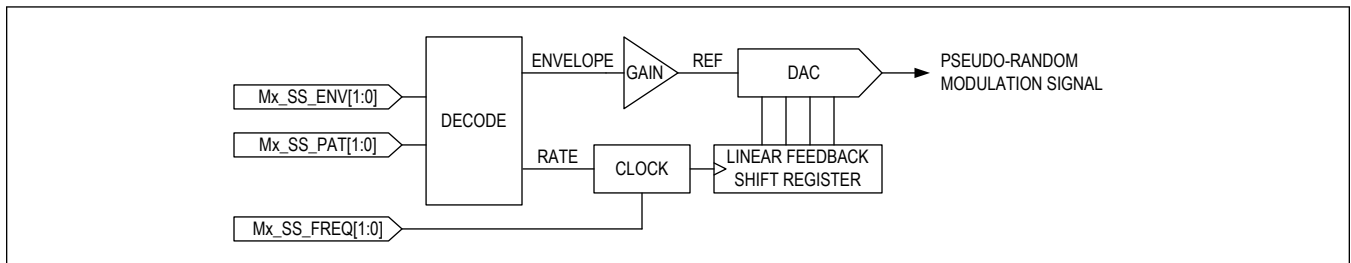

Figure 6. Pseudo-Random Modulator Engine

The modulation envelope and frequency are programmable by the $Mx_SS_ENV[1:0]$ and the $Mx_FREQ[1:0]$ bits. The F_{SS_MOD} sets the frequency at which the LFSR wraps back to the seed value. The clock rate of the LFSR is the F_{LFSR} . This is the frequency at which one pseudo-random value changes to another. An example is shown in Figure 7.

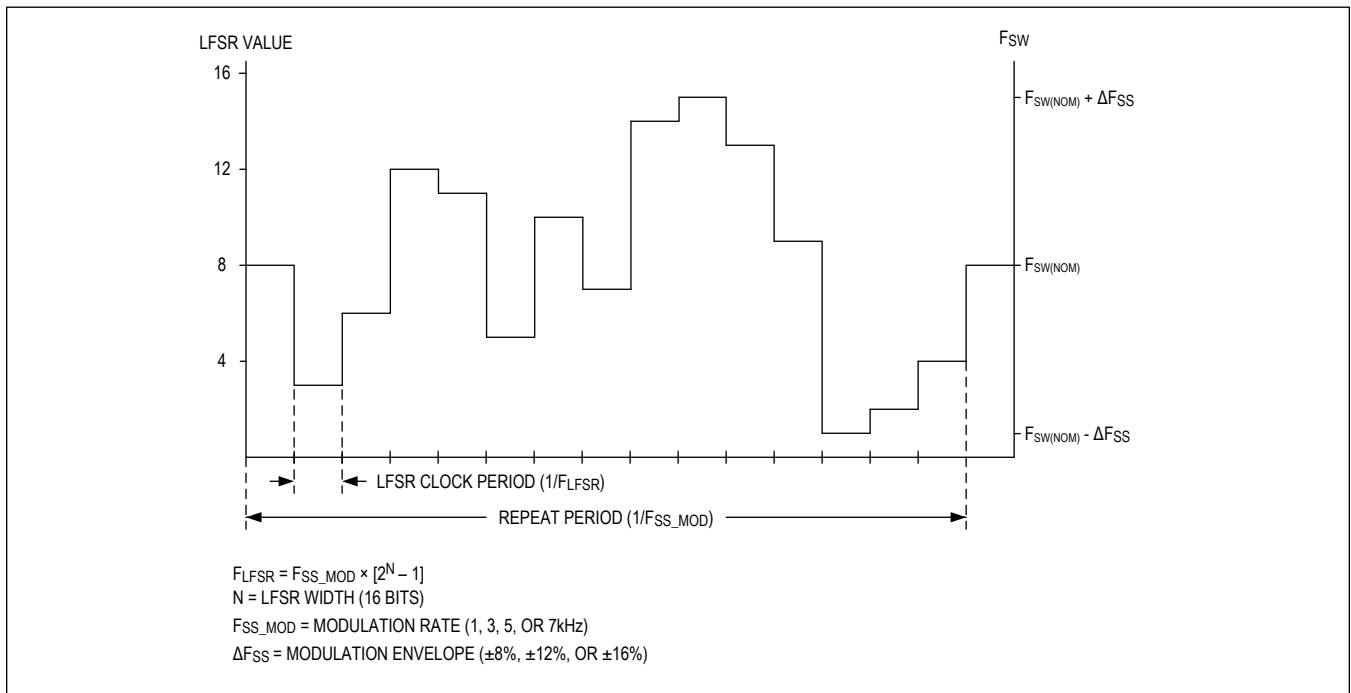

Figure 7. 4-Bit Pseudo-Random Modulation Signal Example

Triangular Pattern

The triangular engine uses a 4-bit up/down synchronous counter to create a stepped triangle pattern as shown in Figure

8. The counter value is converted to an analog signal and then amplified before being added to the output of the on-time generator circuit. The counter value progressively shortens and lengthens the on-time. This causes the Buck controller to progressively increase and decrease the switching frequency to maintain voltage regulation. Each Buck has its own triangular pattern generator.

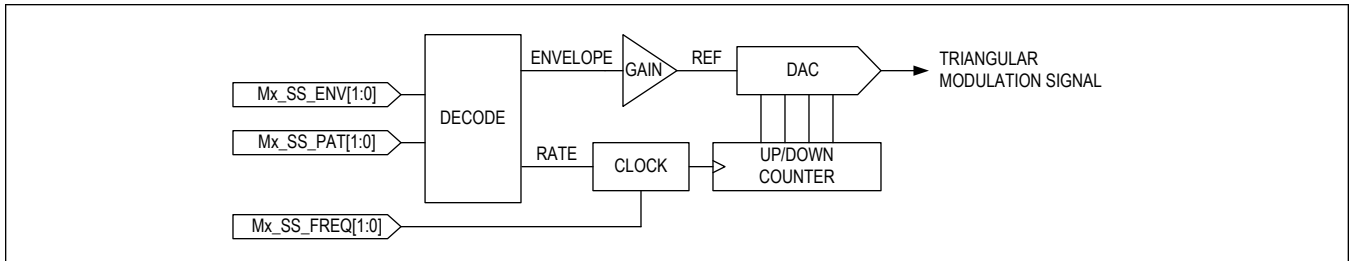

Figure 8. Triangular Modulator Engine

The modulation envelope and frequency are programmable by the Mx_SS_ENV[1:0] and the Mx_FREQ[1:0] bits. The F_{SS_MOD} sets the frequency at which the counter returns to the same value. The clock rate of the counter is the F_{COUNT}. This is the frequency at which the frequency changes from one value to another. An example is shown in Figure 9.

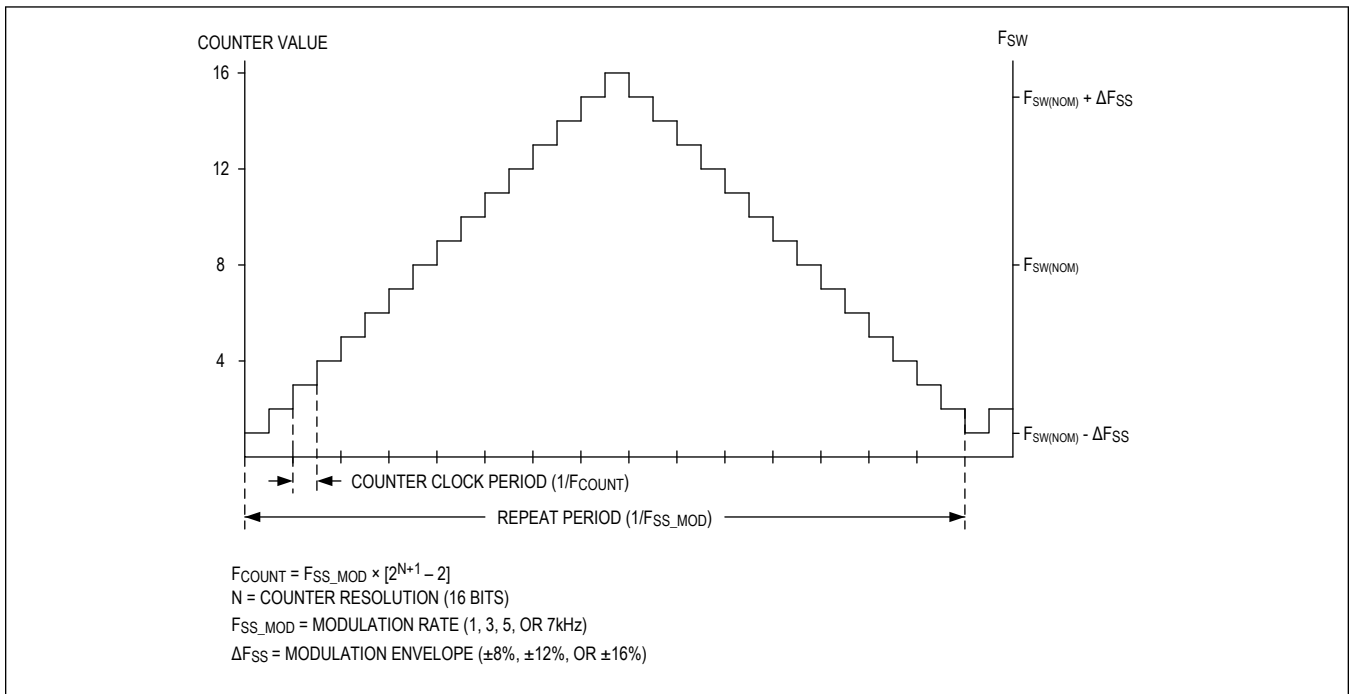

Figure 9. 4-Bit Triangular Modulation Signal Example

Inductor Current Limits

The MAX77540 has a cycle-by-cycle current limit feature that prevents the inductor current (in each phase) from increasing beyond the I_{PLIM}. If an on-time is ended by the peak current limit, the Buck prevents a new on-time from starting until the inductor current falls below the valley current limit (I_{V_LIM}) which is typically set 1A less than the I_{PLIM}. This prevents the inductor current from increasing uncontrollably due to the overloaded output. In case the on-time determined by the given operating condition is less than 130ns (typ), the next on-time pulse is not triggered until the inductor current hits the I_{V_LIM}. Each Buck has four PLIM thresholds which are individually set by Mx_ILIM[1:0] bits. See

the [Register Map](#) for more details. The programmable PLIM thresholds allow an optimal circuit protection and inductor selections for the given operating conditions and load requirements.

Power-OK (POK)

The MAX77540 features the Power-OK (POK) comparators to monitor the quality of each Buck output. The Mx_POK status bits continuously reflect the status of these monitors. The quality of Buck output can be directly monitored by the corresponding POKx pins. The POKx are active-high, open-drain outputs that require an external pullup resistor (typ 10kΩ to 100kΩ). The POKx output goes high if the corresponding Buck output voltage rises above the V_{POK_R} (typ 82% of the V_{OUT} target) when the soft-start is completed. When the corresponding Buck falls below the V_{POK_F} (typ 78% of the V_{OUT} target), the POKx output goes low.

The Mx_POKFLT_I interrupt is also available to signal whenever any of the Mx_POK status bit changes from 1 to 0. Each Mx_POKFLT_I bit is individually maskable. See the [Register Map](#) for more details.

Fault Protection

The MAX77540 has fault protection scheme designed to protect itself from abnormal conditions. The Bucks have additional short-circuit protection (SCP) and thermal shutdown (T_{SHDN}) protection functions that operate according to the state machine in [Figure 10](#). The operation of the state machine is summarized as follows:

- If one of the enabled Buck outputs falls below the V_{POK_F} (typ 78% of regulation target), then the Mx_POKFLT_I asserts.
- If one of the enabled Buck outputs stays below the V_{POK_R} (typ 82% of regulation target) for longer than t_{POK_TO}, then the corresponding output is disabled immediately, while other outputs initiate soft-stop.
- If one of the phases continues to have an unbroken string of on-times terminated by current limit for longer than the t_{POK_TO}, then the corresponding output is disabled immediately, while other outputs initiate soft-stop (the Mx_SCPFLT_I interrupt asserts when unmasked).
- If one of the enabled Buck outputs falls below the V_{SCP} (typ 20% of regulation target), then the corresponding output is disabled immediately, while other outputs initiate soft-stop.
- If the junction temperature exceeds the T_{SHDN} (typ 165°C), then all Bucks outputs are disabled immediately and the T_{SHDN_I} interrupt asserts.
- The POK and SCP monitoring is not active during the soft-start and soft-stop.

To exit the fault state, all of the following conditions need to be satisfied:

- The die temperature falls below the T_{SHDN} by approximately 15°C (T_{SHDN} = 0).
- One or all Bucks are disabled:
 - If the fault state was latched due to SCP, then only the Buck that caused SCP needs to be disabled to clear fault.
 - If the fault state was latched due to T_{SHDN}, then all Buck outputs need to be disabled to clear fault.

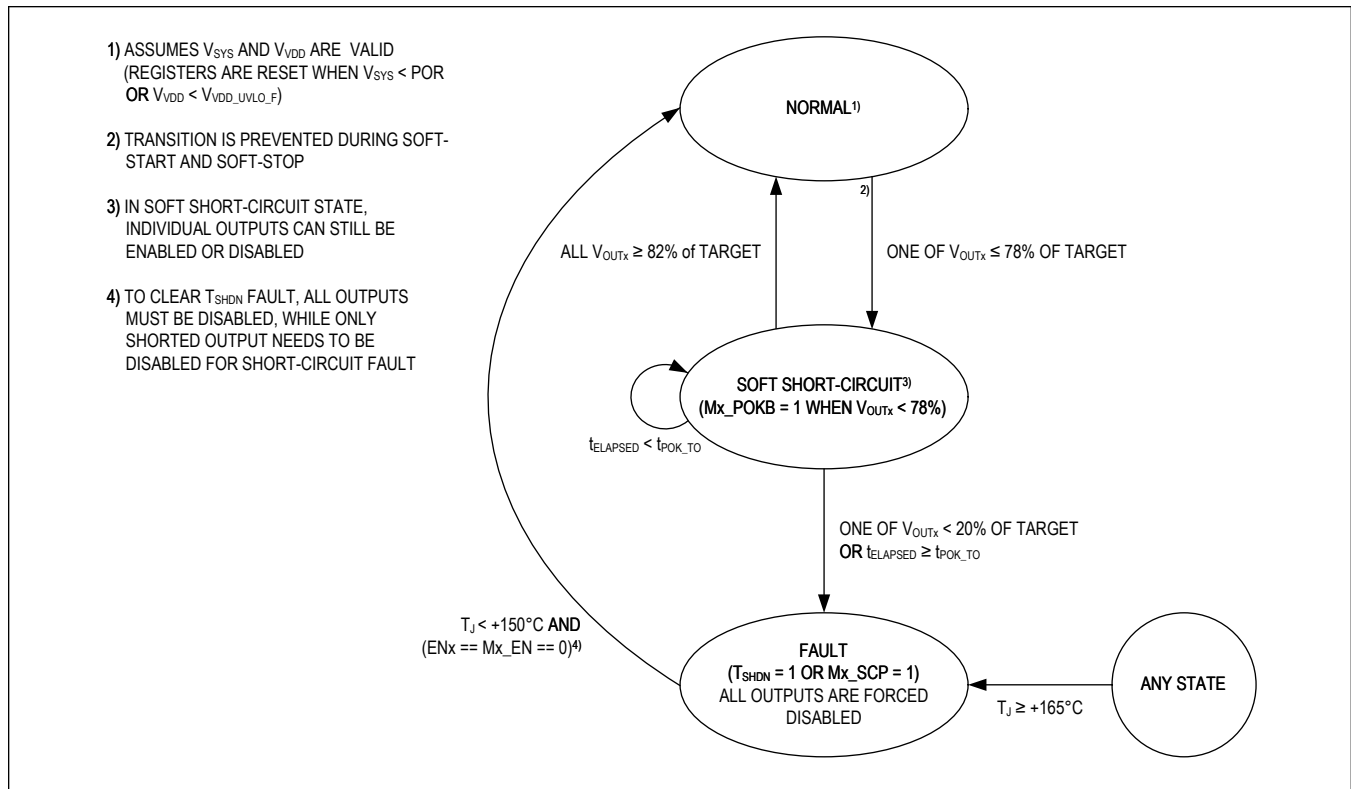

Figure 10. Fault Protection State Diagram

Detailed Description—I²C Serial Interface

The MAX77540 features an I²C version 3.0 compatible, 2-wire serial interface consisting of a serial clock line (SCL) and a bidirectional serial data line (SDA). The MAX77540 is a slave-only device that relies on an external bus master to generate the SCL clock. The SCL clock rates from 0Hz to 3.4MHz are supported. As I²C is an open-drain bus, the SDA and the SCL require external pullup resistors.

Slave Address

The I²C communication controller implements a 7-bit slave addressing and the slave address is user-selectable using ADDR pin on the PCB. All other slave addresses not listed in Table 10 are not acknowledged. The device uses 8-bit registers with 8-bit register addressing. They support standard communication protocols: (1) Writing to a single register, (2) Writing to multiple sequential registers with an autoincrement data pointer, (3) Reading from a single register, and (4) Reading from multiple sequential registers with an autoincrement data pointer. For additional information about I²C protocols, refer to I²C specifications.

Table 10. I²C Slave Address Options

| ADDR PIN | 7-BIT SLAVE ADDRESS | 8-BIT WRITE ADDRESS | 8-BIT READ ADDRESS |
|-----------------|---------------------|---------------------|--------------------|
| 0V | 7'h75 (111 0101) | 0xEA (1110 1010) | 0xEB (1110 1011) |
| V _{DD} | 7'h76 (111 0110) | 0xEC (1110 1100) | 0xED (1110 1101) |
| FLOAT | 7'h77 (111 0111) | 0xEE (1110 1110) | 0xEF (1110 1111) |

Register Map

MAX77540 WLP Package

| ADDRESS | NAME | MSB | | | | | | LSB | |
|-------------------------------|-----------------------------------|----------------|--------------------|-----------------|---------------|----------------|-----------------|-----------------|--|
| GLOBAL CONFIGURATION 1 | | | | | | | | | |
| 0x00 | INT_SRC[7:0] | RESERVED[5:0] | | | | | BUCK_I | TOPSYS_I | |
| 0x01 | INT_SRC_M[7:0] | RESERVED[5:0] | | | | | BUCK_M | TOPSYS_M | |
| 0x02 | TOPSYS_INT[7:0] | RESERVED[1:0] | EXT_FR EQ_DET_I | ALT_SW O_I | UVLO_I | TSHDN_I | TJ_140C_I | TJ_120C_I | |
| 0x03 | TOPSYS_INT_M[7:0] | RESERVED[1:0] | EXT_FR EQ_DET_M | ALT_SW O_M | UVLO_M | TSHDN_M | TJ_140C_M | TJ_120C_M | |
| 0x04 | TOPSYS_STAT[7:0] | RESERVED[1:0] | EXT_FR EQ_DET | ALT_SW O | UVLO | TSHDN | TJ_140 | TJ_120 | |
| 0x06 | DEVICE_CFG1[7:0] | RESERVED[2:0] | | SEL1_LATCH[4:0] | | | | | |
| 0x07 | DEVICE_CFG2[7:0] | RESERVED[2:0] | | SEL2_LATCH[4:0] | | | | | |
| 0x08 | TOPSYS_CFG[7:0] | RESERVED[4:0] | | | | RESERVED | RESERVED | DIS_ALT_IN | |
| 0x09 | PROT_CFG[7:0] | RESERVED[4:0] | | | | EN_FTM ON | POK_TO[1:0] | | |
| 0x0B | EN_CTRL[7:0] | RESERVED[1:0] | M2_LPM | M1_LPM | RESERVED[1:0] | | M2_EN | M1_EN | |
| GLOBAL CONFIGURATION 2 | | | | | | | | | |
| 0x11 | GLB_CFG1[7:0] | RESERVED[1:0] | SSTOP_SR[2:0] | | | SSTRT_SR[2:0] | | | |
| BUCK1 CONFIGURATION | | | | | | | | | |
| 0x20 | BUCK_INT[7:0] | RESERVED[1:0] | M2_SCF LT_I | M1_SCF LT_I | RESERVED[1:0] | | M2_POK FLT_I | M1_POK FLT_I | |
| 0x21 | BUCK_INT_M[7:0] | RESERVED[1:0] | M2_SCF LT_M | M1_SCF LT_M | RESERVED[1:0] | | M2_POK FLT_M | M1_POK FLT_M | |
| 0x22 | BUCK_STAT[7:0] | RESERVED[1:0] | M2_SCF LT | M1_SCF LT | RESERVED[1:0] | | M2_POK | M1_POK | |
| 0x23 | M1_VOUT[7:0] | M1_VOUT[7:0] | | | | | | | |
| 0x25 | M1_CFG1[7:0] | M1_RNG[1:0] | | M1_RD_SR[2:0] | | M1_RU_SR[2:0] | | | |
| 0x26 | M1_CFG2[7:0] | M1_SS_ENV[1:0] | | M1_SS_FREQ[1:0] | | M1_SS_PAT[1:0] | M1_FSR EN | M1_FPW M | |
| 0x27 | M1_CFG3[7:0] | M1_ADI S100 | M1_ADI S1 | M1_ULT RA | M1_FTR AK | M1_FREQ[1:0] | M1_ILIM[1:0] | | |
| BUCK2 CONFIGURATION | | | | | | | | | |
| 0x33 | M2_VOUT[7:0] | M2_VOUT[7:0] | | | | | | | |
| 0x35 | M2_CFG1[7:0] | M2_RNG[1:0] | | M2_RD_SR[2:0] | | M2_RU_SR[2:0] | | | |
| 0x36 | M2_CFG2[7:0] | M2_SS_ENV[1:0] | | M2_SS_FREQ[1:0] | | M2_SS_PAT[1:0] | M2_FSR EN | M2_FPW M | |
| 0x37 | M2_CFG3[7:0] | M2_ADI S100 | M2_ADI S1 | M2_ULT RA | M2_FTR AK | M2_FREQ[1:0] | M2_ILIM[1:0] | | |

Register Details

INT_SRC (0x00)

| BIT | 7 | 6 | 5 | 4 | 3 | 2 | 1 | 0 |
|-------------|---------------|---|---|---|---|---|-----------|-----------|
| Field | RESERVED[5:0] | | | | | | BUCK_I | TOPSYS_I |
| Reset | 0x0 | | | | | | 0x0 | 0x0 |
| Access Type | Read Only | | | | | | Read Only | Read Only |

| BITFIELD | BITS | DESCRIPTION | DECODE |
|----------|------|----------------------------|--|
| RESERVED | 7:2 | Reserved. Returns '0' | |
| BUCK_I | 1 | Buck Interrupt Source | 0x0 = Interrupt event in Buck has not detected 0x1 = Interrupt event in Buck has detected |
| TOPSYS_I | 0 | Top-Level Interrupt Source | 0x0 = Interrupt event in TOPSYS has not detected 0x1 = Interrupt event in TOPSYS has detected |

INT_SRC_M (0x01)

| BIT | 7 | 6 | 5 | 4 | 3 | 2 | 1 | 0 |
|-------------|---------------|---|---|---|---|---|-------------|-------------|
| Field | RESERVED[5:0] | | | | | | BUCK_M | TOPSYS_M |
| Reset | 0x3F | | | | | | 0x1 | 0x0 |
| Access Type | Write, Read | | | | | | Write, Read | Write, Read |

| BITFIELD | BITS | DESCRIPTION | DECODE |
|----------|------|---------------------------------|--|
| RESERVED | 7:2 | Reserved. Returns '1' | |
| BUCK_M | 1 | Buck Interrupt Source Mask | 0x0 = Enable BUCK_I 0x1 = Mask BUCK_I |
| TOPSYS_M | 0 | Top-Level Interrupt Source Mask | 0x0: Enable TOPSYS_I 0x1: Mask TOPSYS_I |

TOPSYS_INT (0x02)

| BIT | 7 | 6 | 5 | 4 | 3 | 2 | 1 | 0 |
|-------------|-----------------|---|-----------------|-----------------|-----------------|-----------------|-----------------|-----------------|
| Field | RESERVED[1:0] | | EXT_FREQ_DET_I | ALT_SWO_I | UVLO_I | TSHDN_I | TJ_140C_I | TJ_120C_I |
| Reset | 0x0 | | 0x0 | 0x0 | 0x0 | 0x0 | 0x0 | 0x0 |
| Access Type | Read Clears All | | Read Clears All | Read Clears All | Read Clears All | Read Clears All | Read Clears All | Read Clears All |

| BITFIELD | BITS | DESCRIPTION | DECODE |
|----------------|------|--|--|
| RESERVED | 7:6 | Reserved. Returns '0' | |
| EXT_FREQ_DET_I | 5 | External Clock Frequency Detection Interrupt | 0x0 = Valid external frequency has not detected at one of FPWMxB inputs 0x1 = Valid external frequency has detected at one of FPWMxB inputs |

| BITFIELD | BITS | DESCRIPTION | DECODE |
|-----------|------|---------------------------------------|--|
| ALT_SWO_I | 4 | Alternate Input Switch-Over Interrupt | 0x0 = Input voltage of internal bias circuitry has not switched to ALT_IN input 0x1 = Input voltage of internal bias circuitry has switched to ALT_IN input |
| UVLO_I | 3 | SYS Undervoltage Lock-Out Interrupt | 0x0 = Input voltage (V _{SYS}) has not dropped below UVLO threshold 0x1 = Input voltage (V _{SYS}) has dropped below UVLO threshold |
| TSHDN_I | 2 | Thermal Shutdown Interrupt | 0x0 = Junction temperature has not risen above TSHDN threshold (165°C) 0x1 = Junction temperature has risen above TSHDN threshold (165°C) |
| TJ_140C_I | 1 | Thermal Warning2 Interrupt | 0x0 = Junction temperature has not risen above 140°C 0x1 = Junction temperature has risen above 140°C |
| TJ_120C_I | 0 | Thermal Warning1 Interrupt | 0x0 = Junction temperature has not risen above 120°C 0x1 = Junction temperature has risen above 120°C |

TOPSYS_INT_M (0x03)

| BIT | 7 | 6 | 5 | 4 | 3 | 2 | 1 | 0 |
|-------------|---------------|---|----------------|-------------|-------------|-------------|-------------|-------------|
| Field | RESERVED[1:0] | | EXT_FREQ_DET_M | ALT_SWO_M | UVLO_M | TSHDN_M | TJ_140C_M | TJ_120C_M |
| Reset | 0x3 | | 0x1 | 0x1 | 0x0 | 0x1 | 0x1 | 0x1 |
| Access Type | Write, Read | | Write, Read | Write, Read | Write, Read | Write, Read | Write, Read | Write, Read |

| BITFIELD | BITS | DESCRIPTION | DECODE |
|----------------|------|---|--|
| RESERVED | 7:6 | Reserved. Returns '1' | |
| EXT_FREQ_DET_M | 5 | External Clock Frequency Detection Interrupt Mask | 0x0 = Enable EXT_FREQ_DET_I 0x1 = Mask EXT_FREQ_DET_I |
| ALT_SWO_M | 4 | Alternate Input Switch-Over Interrupt Mask | 0x0 = Enable ALT_SWO_I 0x1 = Mask ALT_SWO_I |
| UVLO_M | 3 | SYS Undervoltage Lock-Out Interrupt Mask | 0x0 = Enable UVLO_I 0x1 = Mask UVLO_I |
| TSHDN_M | 2 | Thermal Shutdown Interrupt Mask | 0x0 = Enable TSHDN_I 0x1 = Mask TSHDN_I |
| TJ_140C_M | 1 | Thermal Warning2 Interrupt Mask | 0x0 = Enable TJ_140C_I 0x1 = Mask TJ_140C_I |
| TJ_120C_M | 0 | Thermal Warning1 Interrupt Mask | 0x0 = Enable TJ_120C_I 0x1 = Mask TJ_120C_I |

TOPSYS_STAT (0x04)

| BIT | 7 | 6 | 5 | 4 | 3 | 2 | 1 | 0 |
|-------------|---------------|---|--------------|-----------|-----------|-----------|-----------|-----------|
| Field | RESERVED[1:0] | | EXT_FREQ_DET | ALT_SWO | UVLO | TSHDN | TJ_140 | TJ_120 |
| Reset | 0x0 | | 0x0 | 0x0 | 0x0 | 0x0 | 0x0 | 0x0 |
| Access Type | Read Only | | Read Only | Read Only | Read Only | Read Only | Read Only | Read Only |

| BITFIELD | BITS | DESCRIPTION | DECODE |
|--------------|------|---|---|
| RESERVED | 7:6 | Reserved. Returns '0' | |
| EXT_FREQ_DET | 5 | External Clock Frequency Detection Status | 0x0 = Valid external frequency is not detected 0x1 = Valid external frequency is detected |
| ALT_SWO | 4 | Alternate Input Switch-Over Status | 0x0 = V _{DD} & V _L LDO is powered from SYS 0x1 = V _{DD} & V _L LDO is powered from ALT_IN |
| UVLO | 3 | SYS Undervoltage Lock-Out Status | 0x0 = V _{SYS} ≥ V _{UVLO_R} 0x1 = V _{SYS} ≤ V _{UVLO_F} |
| TSHDN | 2 | Thermal Shutdown Status | 0x0 = T _J ≤ 150°C 0x1 = T _J ≥ 165°C |
| TJ_140 | 1 | Thermal Warning2 Status | 0x0 = T _J ≤ 125°C 0x1 = T _J ≥ 140°C |
| TJ_120 | 0 | Thermal Warning1 Status | 0x0 = T _J ≤ 105°C 0x1 = T _J ≥ 120°C |

DEVICE_CFG1 (0x06)

| BIT | 7 | 6 | 5 | 4 | 3 | 2 | 1 | 0 |
|-------------|---------------|---|---|-----------------|---|---|---|---|
| Field | RESERVED[2:0] | | | SEL1_LATCH[4:0] | | | | |
| Reset | 0x0 | | | 0x0 | | | | |
| Access Type | Read Only | | | Read Only | | | | |

| BITFIELD | BITS | DESCRIPTION |
|------------|------|-----------------------|
| RESERVED | 7:5 | Reserved. Returns '0' |
| SEL1_LATCH | 4:0 | SEL1 Latched Code |

DEVICE_CFG2 (0x07)

| BIT | 7 | 6 | 5 | 4 | 3 | 2 | 1 | 0 |
|-------------|---------------|---|---|-----------------|---|---|---|---|
| Field | RESERVED[2:0] | | | SEL2_LATCH[4:0] | | | | |
| Reset | 0x0 | | | 0x0 | | | | |
| Access Type | Read Only | | | Read Only | | | | |

| BITFIELD | BITS | DESCRIPTION |
|------------|------|-----------------------|
| RESERVED | 7:5 | Reserved. Returns '0' |
| SEL2_LATCH | 4:0 | SEL2 Latched Code |

TOPSYS_CFG (0x08)

| BIT | 7 | 6 | 5 | 4 | 3 | 2 | 1 | 0 |
|-------------|---------------|---|---|---|---|-------------|-------------|----------------|
| Field | RESERVED[4:0] | | | | | RESERVED | RESERVED | DIS_ALT_I N |
| Reset | 0x0 | | | | | 0x0 | 0x0 | 0x0 |
| Access Type | Write, Read | | | | | Write, Read | Write, Read | Write, Read |

| BITFIELD | BITS | DESCRIPTION | DECODE |
|------------|------|--|---|
| RESERVED | 7:3 | Reserved. Returns '0' | |
| RESERVED | 2 | Reserved. Returns '0' | |
| RESERVED | 1 | Reserved. Returns '0' | |
| DIS_ALT_IN | 0 | Alternative Input for V _{DD} and V _L LDO | 0x0 = Allow V _{DD} and V _L supply switch over to ALT_IN 0x1 = V _{DD} and V _L LDO is powered from SYS |

PROT_CFG (0x09)

| BIT | 7 | 6 | 5 | 4 | 3 | 2 | 1 | 0 |
|-------------|---------------|---|---|---|---|-------------|-------------|---|
| Field | RESERVED[4:0] | | | | | EN_FTMON | POK_TO[1:0] | |
| Reset | 0x0 | | | | | 0x0 | 0x0 | |
| Access Type | Write, Read | | | | | Write, Read | Write, Read | |

| BITFIELD | BITS | DESCRIPTION | DECODE |
|----------|------|-------------------------------------|--|
| RESERVED | 7:3 | Reserved. Returns '0' | |
| EN_FTMON | 2 | Forced Junction Temperature Monitor | 0x0 = Monitor junction temperature only when one or more outputs is/are enabled 0x1 = Monitor junction temperature even when all the outputs are disabled |
| POK_TO | 1:0 | Power-OK Fault Time-Out Setting | 0x0 = Disabled 0x1 = 25ms 0x2 = 50ms 0x3 = 100ms |

EN_CTRL (0x0B)

| BIT | 7 | 6 | 5 | 4 | 3 | 2 | 1 | 0 |
|-------------|---------------|---|-------------|-------------|---------------|---|-------------|-------------|
| Field | RESERVED[1:0] | | M2_LPM | M1_LPM | RESERVED[1:0] | | M2_EN | M1_EN |
| Reset | 0x0 | | 0x0 | 0x0 | 0x0 | | 0x0 | 0x0 |
| Access Type | Write, Read | | Write, Read | Write, Read | Write, Read | | Write, Read | Write, Read |

| BITFIELD | BITS | DESCRIPTION | DECODE |
|----------|------|-------------------------------------|-------------------------------|
| RESERVED | 7:6 | Reserved. Returns '0' | |
| M2_LPM | 5 | Buck Master2 Low Power Mode Control | 0x0 = Disable 0x1 = Enable |
| M1_LPM | 4 | Buck Master1 Low Power Mode Control | 0x0 = Disable 0x1 = Enable |

| BITFIELD | BITS | DESCRIPTION | DECODE |
|----------|------|-----------------------------|---|
| RESERVED | 3:2 | Reserved. Returns '0' | |
| M2_EN | 1 | Buck Master2 Enable Control | 0x0 = Disable 0x1 = Enable ('OR' Logic with EN2 Input) |
| M1_EN | 0 | Buck Master1 Enable Control | 0x0 = Disable 0x1 = Enable ('OR' Logic with EN1 Input) |

GLB_CFG1 (0x11)

| BIT | 7 | 6 | 5 | 4 | 3 | 2 | 1 | 0 |
|-------------|---------------|---|---------------|---|---|---------------|---|---|
| Field | RESERVED[1:0] | | SSTOP_SR[2:0] | | | SSTRT_SR[2:0] | | |
| Reset | 0x0 | | 0x0 | | | 0x4 | | |
| Access Type | Write, Read | | Write, Read | | | Write, Read | | |

| BITFIELD | BITS | DESCRIPTION | DECODE |
|----------|------|-------------------------------------|---|
| RESERVED | 7:6 | Reserved. Returns '0' | |
| SSTOP_SR | 5:3 | Global Soft-Stop Slew-Rate Control | 0x0 = -0.15mV/μs 0x1 = -0.625mV/μs 0x2 = -1.25mV/μs 0x3 = -2.5mV/μs 0x4 = -5.0mV/μs 0x5 = -10mV/μs 0x6 = -20mV/μs 0x7 = -40mV/μs |
| SSTRT_SR | 2:0 | Global Soft-Start Slew-Rate Control | 0x0 = 0.15mV/μs 0x1 = 0.625mV/μs 0x2 = 1.25mV/μs 0x3 = 2.5mV/μs 0x4 = 5.0mV/μs 0x5 = 10mV/μs 0x6 = 20mV/μs 0x7 = 40mV/μs |

BUCK_INT (0x20)

| BIT | 7 | 6 | 5 | 4 | 3 | 2 | 1 | 0 |
|-------------|-----------------|---|-----------------|-----------------|-----------------|---|-----------------|-----------------|
| Field | RESERVED[1:0] | | M2_SCFLT_I | M1_SCFLT_I | RESERVED[1:0] | | M2_POKFL_T_I | M1_POKFL_T_I |
| Reset | 0x0 | | 0x0 | 0x0 | 0x0 | | 0x0 | 0x0 |
| Access Type | Read Clears All | | Read Clears All | Read Clears All | Read Clears All | | Read Clears All | Read Clears All |

| BITFIELD | BITS | DESCRIPTION | DECODE |
|------------|------|--|--|
| RESERVED | 7:6 | Reserved. Returns '0' | |
| M2_SCFLT_I | 5 | Buck Master2 Short-Circuit Fault Interrupt | 0x0 = Buck Master2 Short-circuit Fault has not been detected 0x1 = Buck Master2 Short-circuit Fault has been detected |

| BITFIELD | BITS | DESCRIPTION | DECODE |
|-------------|------|--|--|
| M1_SCFLT_I | 4 | Buck Master1 Short-Circuit Fault Interrupt | 0x0 = Buck Master1 Short-circuit Fault has not been detected 0x1 = Buck Master1 Short-circuit Fault has been detected |
| RESERVED | 3:2 | Reserved. Returns '0' | |
| M2_POKFLT_I | 1 | Buck Master2 Power-OK Fault Interrupt | 0x0 = Buck Master2 Power-OK Fault has not been detected 0x1 = Buck Master2 Power-OK Fault has not been detected |
| M1_POKFLT_I | 0 | Buck Master1 Power-OK Fault Interrupt | 0x0 = Buck Master1 Power-OK Fault has not been detected 0x1 = Buck Master1 Power-OK Fault has been detected |

BUCK_INT_M (0x21)

| BIT | 7 | 6 | 5 | 4 | 3 | 2 | 1 | 0 |
|-------------|---------------|---|-------------|-------------|---------------|---|-------------|-------------|
| Field | RESERVED[1:0] | | M2_SCFLT_M | M1_SCFLT_M | RESERVED[1:0] | | M2_POKFLT_M | M1_POKFLT_M |
| Reset | 0x3 | | 0x1 | 0x1 | 0x3 | | 0x1 | 0x1 |
| Access Type | Write, Read | | Write, Read | Write, Read | Write, Read | | Write, Read | Write, Read |

| BITFIELD | BITS | DESCRIPTION | DECODE |
|-------------|------|---|--|
| RESERVED | 7:6 | Reserved. Returns '1' | |
| M2_SCFLT_M | 5 | Buck Master2 Short-Circuit Fault Interrupt Mask | 0x0 = Enable M2_SCFLT_I 0x1 = Mask M2_SCFLT_I |
| M1_SCFLT_M | 4 | Buck Master1 Short-Circuit Fault Interrupt Mask | 0x0 = Enable M1_SCFLT_I 0x1 = Mask M1_SCFLT_I |
| RESERVED | 3:2 | Reserved. Returns '1' | |
| M2_POKFLT_M | 1 | Buck Master2 Power-OK Fault Interrupt Mask | 0x0 = Enable M2_POKFLT_I 0x1 = Mask M2_POKFLT_I |
| M1_POKFLT_M | 0 | Buck Master1 Power-OK Fault Interrupt Mask | 0x0 = Enable M1_POKFLT_I 0x1 = Mask M1_POKFLT_I |

BUCK_STAT (0x22)

| BIT | 7 | 6 | 5 | 4 | 3 | 2 | 1 | 0 |
|-------------|---------------|---|-----------|-----------|---------------|---|-----------|-----------|
| Field | RESERVED[1:0] | | M2_SCFLT | M1_SCFLT | RESERVED[1:0] | | M2_POK | M1_POK |
| Reset | 0x0 | | 0x0 | 0x0 | 0x0 | | 0x0 | 0x0 |
| Access Type | Read Only | | Read Only | Read Only | Read Only | | Read Only | Read Only |

| BITFIELD | BITS | DESCRIPTION | DECODE |
|----------|------|---|--|
| RESERVED | 7:6 | Reserved. Returns '0' | |
| M2_SCFLT | 5 | Buck Master2 Short-Circuit Fault Status | 0x0 = Buck Master2 output voltage is higher than its SCP threshold, or Buck Master2 is disabled 0x1 = Buck Master2 output voltage is lower than its SCP threshold |

| BITFIELD | BITS | DESCRIPTION | DECODE |
|----------|------|---|--|
| M1_SCFLT | 4 | Buck Master1 Short-Circuit Fault Status | 0x0 = Buck Master1 output voltage is higher than its SCP threshold, or Buck Master1 is disabled 0x1 = Buck Master1 output voltage is lower than its SCP threshold |
| RESERVED | 3:2 | Reserved. Returns '0' | |
| M2_POK | 1 | Buck Master2 Power-OK Status | 0x0 = Buck Master2 output voltage is lower than its POK threshold, or Buck Master2 is disabled 0x1 = Buck Master2 output voltage is higher than its POK threshold |
| M1_POK | 0 | Buck Master1 Power-OK Status | 0x0 = Buck Master1 output voltage is lower than its POK threshold, or Buck Master1 is disabled 0x1 = Buck Master1 output voltage is higher than its POK threshold |

M1_VOUT (0x23)

| BIT | 7 | 6 | 5 | 4 | 3 | 2 | 1 | 0 |
|-------------|--------------|---|---|---|---|---|---|---|
| Field | M1_VOUT[7:0] | | | | | | | |
| Reset | 0x41 | | | | | | | |
| Access Type | Write, Read | | | | | | | |

| BITFIELD | BITS | DESCRIPTION | DECODE |
|----------|------|--|--|
| M1_VOUT | 7:0 | Buck Master1 Output Voltage Control Register | When M1_RNG = 0x0: 0x0 - 0x8B = (0.5 + 0.005 x M1_VOUT)V 0x8C - 0xFF = 1.20V When M1_RNG = 0x1: 0x0 - 0x8B = (1.0 + 0.01 x M1_VOUT)V 0x8C - 0xFF = 2.40V When M1_RNG = 0x2: 0x0 - 0x9F = (2.0 + 0.02 x M1_VOUT)V 0xA0 - 0xFF = 5.20V |

M1_CFG1 (0x25)

| BIT | 7 | 6 | 5 | 4 | 3 | 2 | 1 | 0 |
|-------------|-------------|---|---------------|---|---|---------------|---|---|
| Field | M1_RNG[1:0] | | M1_RD_SR[2:0] | | | M1_RU_SR[2:0] | | |
| Reset | 0x2 | | 0x0 | | | 0x4 | | |
| Access Type | Write, Read | | Write, Read | | | Write, Read | | |

| BITFIELD | BITS | DESCRIPTION | DECODE |
|----------|------|--|---|
| M1_RNG | 7:6 | Buck Master1 Output Voltage Range Setting (Register setting must not be changed while the output is enabled) | 0x0 = Low-range (0.5V to 1.2V, 5mV step) 0x1 = Mid-range (1.0V to 2.4V, 10mV step) 0x2 = High-range (2.0V to 5.2V, 20mV step) 0x3 = Reserved |

| BITFIELD | BITS | DESCRIPTION | DECODE |
|----------|------|--|---|
| M1_RD_SR | 5:3 | Buck Master1 Ramp-Down Slew-Rate Setting | 0x0 = -0.15mV/μs 0x1 = -0.625mV/μs 0x2 = -1.25mV/μs 0x3 = -2.5mV/μs 0x4 = -5.0mV/μs 0x5 = -10mV/μs 0x6 = -20mV/μs 0x7 = -40mV/μs |
| M1_RU_SR | 2:0 | Buck Master1 Ramp-Up Slew-Rate Setting | 0x0 = 0.15mV/μs 0x1 = 0.625mV/μs 0x2 = 1.25mV/μs 0x3 = 2.5mV/μs 0x4 = 5.0mV/μs 0x5 = 10mV/μs 0x6 = 20mV/μs 0x7 = 40mV/μs |

M1_CFG2 (0x26)

| BIT | 7 | 6 | 5 | 4 | 3 | 2 | 1 | 0 |
|-------------|----------------|---|-----------------|---|----------------|---|-------------|-------------|
| Field | M1_SS_ENV[1:0] | | M1_SS_FREQ[1:0] | | M1_SS_PAT[1:0] | | M1_FSREN | M1_FPWM |
| Reset | 0x0 | | 0x0 | | 0x3 | | 0x1 | 0x0 |
| Access Type | Write, Read | | Write, Read | | Write, Read | | Write, Read | Write, Read |

| BITFIELD | BITS | DESCRIPTION | DECODE |
|------------|------|--|---|
| M1_SS_ENV | 7:6 | Buck Master1 Spread Spectrum Envelope Setting | 0x0 = Disable 0x1 = ±8% 0x2 = ±12% 0x3 = ±16% |
| M1_SS_FREQ | 5:4 | Buck Master1 Spread Spectrum Frequency Setting | 0x0 = 1kHz 0x1 = 3kHz 0x2 = 5kHz 0x3 = 7kHz |
| M1_SS_PAT | 3:2 | Buck Master1 Spread Spectrum Pattern Setting | 0x0 = Triangular Pattern (0001b to 1111b) 0x1 = Pseudo-Random Polynomial (x ⁴ + x + 1) 0x2 = Pseudo-Random Polynomial (x ⁴ + x ³ + 1) 0x3 = Pseudo-Random Polynomial (Alternating "x ⁴ + x + 1" and "x ⁴ + x ³ + 1" every cycle) |
| M1_FSREN | 1 | Buck Master1 Falling Slew-rate Control | 0x0 = Disable (Buck does not sink current from C _{OUT} in SKIP or LP-SKIP mode) 0x1 = Enable (Buck operates in FPWM mode to sink current from C _{OUT} when its V _{OUT(TARGET)} is lower than the actual V _{OUT}) |
| M1_FPWM | 0 | Buck Master1 Forced-PWM Control | 0x0 = Disable (Automatic SKIP mode operation under light load condition) 0x1 = Enable ('OR' Logic with FPWM1B input) |

M1_CFG3 (0x27)

| BIT | 7 | 6 | 5 | 4 | 3 | 2 | 1 | 0 |
|-------------|----------------|-------------|-------------|-------------|--------------|---|--------------|---|
| Field | M1_ADIS10 0 | M1_ADIS1 | M1_ULTRA | M1_FTRAK | M1_FREQ[1:0] | | M1_ILIM[1:0] | |
| Reset | 0x1 | 0x0 | 0x0 | 0x0 | 0x1 | | 0x3 | |
| Access Type | Write, Read | Write, Read | Write, Read | Write, Read | Write, Read | | Write, Read | |

| BITFIELD | BITS | DESCRIPTION | DECODE |
|------------|------|---|---|
| M1_ADIS100 | 7 | Buck Master1 100Ω Active Discharge | 0x0 = Disable 0x1 = Enable |
| M1_ADIS1 | 6 | Buck Master1 1Ω Active Discharge, Note that 1Ω active discharge must be disabled when falling slew-rate function of corresponding output is disabled (M1_FSREN = 0) | 0x0 = Disable 0x1 = Enable (Active for 1ms after Soft-stop is completed) |
| M1_ULTRA | 5 | Buck Master1 Ultrasonic Mode Control | 0x0 = Disable 0x1 = Enable |
| M1_FTRAK | 4 | Buck Master1 Internal Frequency Tracking Control | 0x0 = Disable 0x1 = Enable |
| M1_FREQ | 3:2 | Buck Master1 Switching Frequency Setting | 0x0 = 0.5MHz 0x1 = 1.0MHz 0x2 = 1.6MHz 0x3 = 1.6MHz |
| M1_ILIM | 1:0 | Buck Master1 Peak Current Limit Setting | 0x0 = 1.50A 0x1 = 2.25A 0x2 = 3.00A 0x3 = 4.50A |

M2_VOUT (0x33)

| BIT | 7 | 6 | 5 | 4 | 3 | 2 | 1 | 0 |
|-------------|--------------|---|---|---|---|---|---|---|
| Field | M2_VOUT[7:0] | | | | | | | |
| Reset | 0x96 | | | | | | | |
| Access Type | Write, Read | | | | | | | |

| BITFIELD | BITS | DESCRIPTION | DECODE |
|----------|------|--|--|
| M2_VOUT | 7:0 | Buck Master2 Output Voltage Control Register | When M2_RNG = 0x0: 0x0 - 0x8B = (0.5 + 0.005 x M2_VOUT)V 0x8C - 0xFF = 1.20V When M2_RNG = 0x1: 0x0 - 0x8B = (1.0 + 0.01 x M2_VOUT)V 0x8C - 0xFF = 2.40V When M2_RNG = 0x2: 0x0 - 0x9F = (2.0 + 0.02 x M2_VOUT)V 0xA0 - 0xFF = 5.20V |

M2_CFG1 (0x35)

| BIT | 7 | 6 | 5 | 4 | 3 | 2 | 1 | 0 |
|--------------------|-------------|---|---------------|---|---|---------------|---|---|
| Field | M2_RNG[1:0] | | M2_RD_SR[2:0] | | | M2_RU_SR[2:0] | | |
| Reset | 0x2 | | 0x0 | | | 0x4 | | |
| Access Type | Write, Read | | Write, Read | | | Write, Read | | |

| BITFIELD | BITS | DESCRIPTION | DECODE |
|----------|------|--|---|
| M2_RNG | 7:6 | Buck Master2 Output Voltage Range Setting (Register setting must not be changed while the output is enabled) | 0x0 = Low-range (0.5V to 1.2V, 5mV step) 0x1 = Mid-range (1.0V to 2.4V, 10mV step) 0x2 = High-range (2.0V to 5.2V, 20mV step) 0x3 = Reserved |
| M2_RD_SR | 5:3 | Buck Master2 Ramp-Down Slew-Rate Setting | 0x0 = -0.15mV/μs 0x1 = -0.625mV/μs 0x2 = -1.25mV/μs 0x3 = -2.5mV/μs 0x4 = -5.0mV/μs 0x5 = -10mV/μs 0x6 = -20mV/μs 0x7 = -40mV/μs |
| M2_RU_SR | 2:0 | Buck Master2 Ramp-Up Slew-Rate Setting | 0x0 = 0.15mV/μs 0x1 = 0.625mV/μs 0x2 = 1.25mV/μs 0x3 = 2.5mV/μs 0x4 = 5.0mV/μs 0x5 = 10mV/μs 0x6 = 20mV/μs 0x7 = 40mV/μs |

M2_CFG2 (0x36)

| BIT | 7 | 6 | 5 | 4 | 3 | 2 | 1 | 0 |
|--------------------|----------------|---|-----------------|---|----------------|---|-------------|-------------|
| Field | M2_SS_ENV[1:0] | | M2_SS_FREQ[1:0] | | M2_SS_PAT[1:0] | | M2_FSREN | M2_FPWM |
| Reset | 0x0 | | 0x0 | | 0x3 | | 0x1 | 0x0 |
| Access Type | Write, Read | | Write, Read | | Write, Read | | Write, Read | Write, Read |

| BITFIELD | BITS | DESCRIPTION | DECODE |
|------------|------|--|---|
| M2_SS_ENV | 7:6 | Buck Master2 Spread Spectrum Envelope Setting | 0x0 = Disable 0x1 = ±8% 0x2 = ±12% 0x3 = ±16% |
| M2_SS_FREQ | 5:4 | Buck Master2 Spread Spectrum Frequency Setting | 0x0 = 1kHz 0x1 = 3kHz 0x2 = 5kHz 0x3 = 7kHz |
| M2_SS_PAT | 3:2 | Buck Master2 Spread Spectrum Pattern Setting | 0x0 = Triangular Pattern (0001b to 1111b) 0x1 = Pseudo-Random Polynomial (x ⁴ + x + 1) 0x2 = Pseudo-Random Polynomial (x ⁴ + x ³ + 1) 0x3 = Pseudo-Random Polynomial (Alternating "x ⁴ + x + 1" and "x ⁴ + x ³ + 1" every cycle) |

| BITFIELD | BITS | DESCRIPTION | DECODE |
|----------|------|--|--|
| M2_FSREN | 1 | Buck Master2 Falling Slew-Rate Control | 0x0 = Disable (Buck does not sink current from C _{OUT} in SKIP or LP-SKIP mode) 0x1 = Enable (Buck operates in FPWM mode to sink current from C _{OUT} when its V _{OUT(TARGET)} is lower than the actual V _{OUT}) |
| M2_FPWM | 0 | Buck Master2 Forced-PWM Control | 0x0 = Disable (Automatic SKIP mode operation under light load condition) 0x1 = Enable ('OR' Logic with FPWM2B input) |

M2_CFG3 (0x37)

| BIT | 7 | 6 | 5 | 4 | 3 | 2 | 1 | 0 |
|-------------|----------------|-------------|-------------|-------------|--------------|---|--------------|---|
| Field | M2_ADIS10 0 | M2_ADIS1 | M2_ULTRA | M2_FTRAK | M2_FREQ[1:0] | | M2_ILIM[1:0] | |
| Reset | 0x1 | 0x0 | 0x0 | 0x0 | 0x1 | | 0x3 | |
| Access Type | Write, Read | Write, Read | Write, Read | Write, Read | Write, Read | | Write, Read | |

| BITFIELD | BITS | DESCRIPTION | DECODE |
|------------|------|--|---|
| M2_ADIS100 | 7 | Buck Master2 100Ω Active Discharge | 0x0 = Disable 0x1 = Enable |
| M2_ADIS1 | 6 | Buck Master2 1Ω Active Discharge. Note that 1Ω active discharge must be disabled when falling slew-rate function of corresponding output is disabled (M2_FSREN = 0). | 0x0 = Disable 0x1 = Enable (Active for 1ms after Soft-stop is completed) |
| M2_ULTRA | 5 | Buck Master2 Ultrasonic Mode Control | 0x0 = Disable 0x1 = Enable |
| M2_FTRAK | 4 | Buck Master2 Internal Frequency Tracking Control | 0x0 = Disable 0x1 = Enable |
| M2_FREQ | 3:2 | Buck Master2 Switching Frequency Setting | 0x0 = 0.5MHz 0x1 = 1.0MHz 0x2 = 1.6MHz 0x3 = 1.6MHz |
| M2_ILIM | 1:0 | Buck Master2 Peak Current Limit Setting | 0x0 = 1.50A 0x1 = 2.25A 0x2 = 3.00A 0x3 = 4.50A |

Applications Information—Dual-Phase Configurable Buck Converter

Inductor Selection

An inductor with a saturation current that is greater than or equal to the peak current limit setting (I_{PLIM}) is recommended. The load current requirement (per phase) of the system is also considered to choose the RMS current rating of the inductor. Inductors with lower saturation current and higher DCR ratings tend to be physically small, however higher values of DCR reduce the efficiency. To choose a suitable inductor for the given application, trade-off the size of the inductor and the DCR value. It is recommended to choose an inductance such that the inductor's ripple current to the average current ratio is between 30% and 60%. Consider the output voltage range when choosing the inductance; in general, 0.47 μ H are suitable for low-range outputs, 1.0 μ H are suitable for mid-range outputs, and 1.5 μ H are suitable for high-range outputs. Note that higher inductances slow down the maximum slew rate of the inductor current, and high duty cycles (V_{IN} close to V_{OUT}) coupled with large inductance can slow down the load transient response.

Table 11. Recommended Inductors

| MANUFACTURER P/N | INDUCTANCE (μ H) | TYPICAL DCR (m Ω) | TYPICAL I_{SAT} (A) | TYPICAL I_{TEMP} (A) | DIMENSION (L x W x H) (mm) |
|------------------|-----------------------|---------------------------|-----------------------|------------------------|----------------------------|
| DFE252012F-R47M | 0.47 \pm 20% | 23 | 6.7 | 4.9 | 2.5 x 2.0 x 1.2 |
| DFE252012F-1R0M | 1.0 \pm 20% | 40 | 4.7 | 3.3 | 2.5 x 2.0 x 1.2 |
| DFE252012F-1R5M | 1.5 \pm 20% | 58 | 3.8 | 2.7 | 2.5 x 2.0 x 1.2 |

For the dual-phase configuration, each phase needs its own inductor with the same inductance value (do not short the LX nodes of different phases together on the PCB). See the [Phase Configuration](#) section for more information regarding different phase configurations.

Input Capacitor Selection

The input capacitor (C_{IN}) reduces the current peaks drawn from the battery or input power source and reduces switching noise in the device. The impedance of the C_{IN} at the switching frequency should be kept very low. Ceramic capacitors with X7R dielectric are highly recommended due to their small size, low ESR, and small temperature coefficients. For most applications, a 10 μ F capacitor is sufficient.

Output Capacitor Selection

The output capacitor (C_{OUT}) is required to keep the output voltage ripple small and to ensure the regulation loop stability. The C_{OUT} must have low impedance at the switching frequency. Ceramic capacitors with X7R dielectric are highly recommended due to their small size, low ESR, and small temperature coefficients. The recommended minimum effective output capacitance **per phase** is shown as follows:

Table 12. Recommended Minimum Effective Output Capacitance

| V_{OUT} RANGE | SWITCHING FREQUENCY (MHz) | MINIMUM EFFECTIVE C_{OUT}^* (μ F) |
|--------------------|---------------------------|--|
| Low (0.3V - 1.2V) | 1 | 42 |
| Mid (1.0V - 2.4V) | 1 | 24 |
| High (2.0V - 5.2V) | 1 | 16 |

* The required minimum $C_{OUT(EFF)}$ is inversely proportional to the switching frequency. For example, an output using $RNG = 0$ and 1MHz switching frequency requires a minimum of 42 μ F of effective output capacitance. Changing the switching frequency to 1.6MHz increases the C_{OUT} requirement to 27 μ F (42 μ F/1.6).

The effective C_{OUT} is the actual capacitance value seen by the Buck output during operation. The nominal capacitance (C_{OUT}) needs to be selected carefully by considering the capacitor's initial tolerance, variation with temperature, and derating with DC bias. Refer to [Tutorial 5527](#) for more information. Larger values of the C_{OUT} (above the required minimum effective) improve load transient performance, but increase the input inrush currents during startup. The output filter capacitor must have low enough ESR to meet output ripple and load transient requirements. The output capacitance

must be high enough to absorb the inductor energy while transitioning from full-load to no-load conditions. When using high-capacitance, low-ESR capacitors, the filter capacitor's ESR dominates the output voltage ripple in CCM. Therefore, the size of the output capacitor depends on the maximum ESR required to meet the output voltage ripple specifications.

General PCB Layout Guidelines

- The power components should be placed first and then small analog control signals.
- It is important to always have a ground layer next to the power stage layer because a solid ground layer provides uninterrupted ground return path between the input and the output caps during switch on-time. (A solid plane minimizes inductance to the absolute minimum and also is a very good thermal conductor and can act as a heat sink.)
- It is recommended to have thick copper for the external high current power layers to minimize the PCB conduction loss and thermal impedance.
- The power stage loop that is made by the input capacitor (C_{IN}), the LX trace, the inductor (L), and the output capacitor (C_{OUT}) coming back to the PGNDx bumps should be minimized for electromagnetic compatibility (EMC) considerations.
- The input capacitors (C_{IN}) should be located close to the input bumps of each phase.
- Bypass capacitors for the V_L , the V_{DD} , and the BSTx pins should be placed as close as possible.
- Analog ground (AGND) and power ground (PGND) bumps should be directly connected to the ground plane separately in order to avoid common impedance ground.
- It is recommended to avoid having direct connection the SYS and its AGND traces to the nearest IN and the PGND traces.
- The output voltage sensing trace should not intersect the power stage (the loop made by the input capacitor, LX trace, inductor, output capacitor, and the PGND)
- It is important to have impedance matching between phases for stable operation in multiphase configuration. (The output PCB trace of each phase should be as symmetric as possible.)
- For multiphase configurations, the output voltage sensing bumps for the master phase should be connected to the middle point of the output phases.

Typical Application Circuits

1+1 Phase Configuration with I²C Enabled

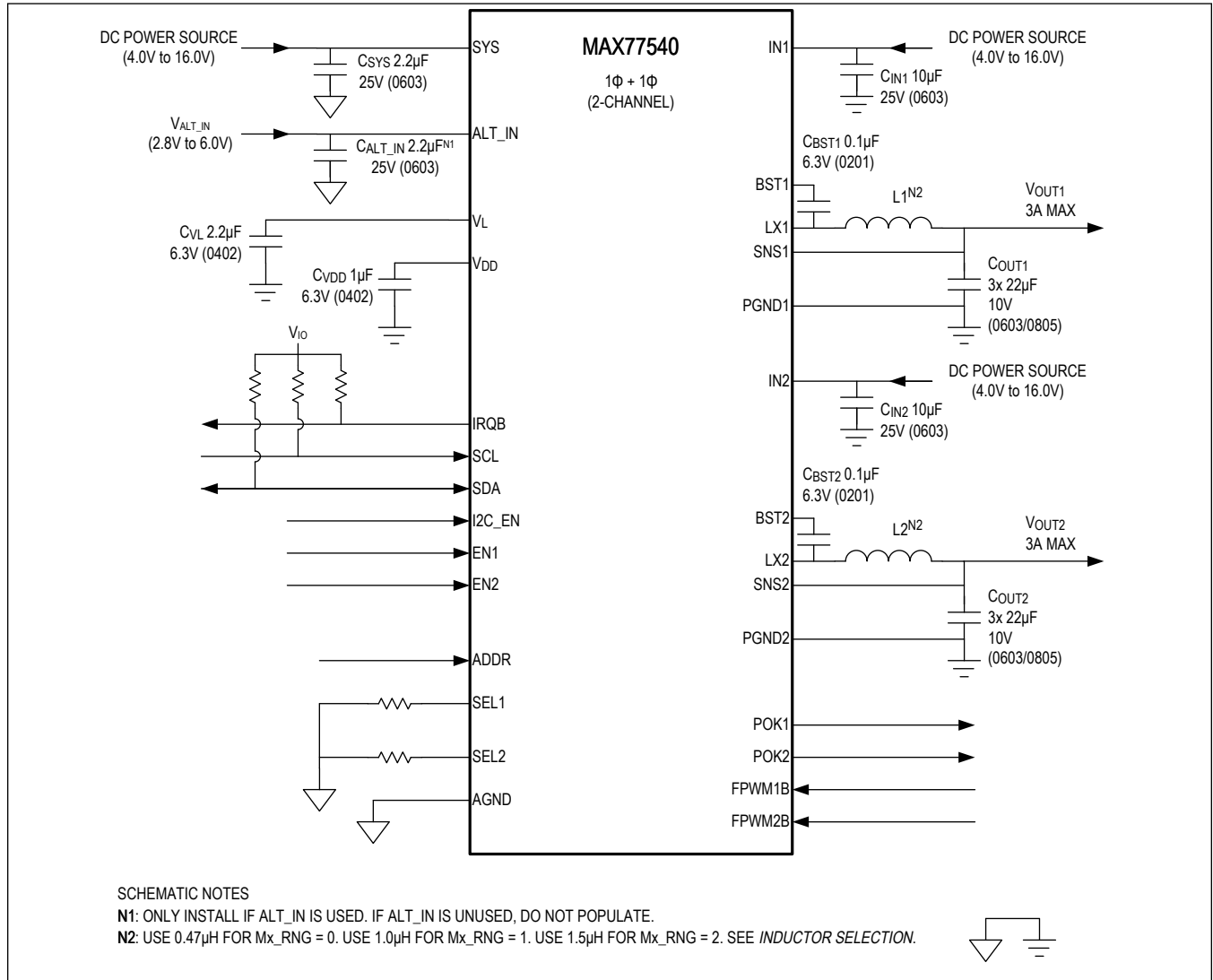

Typical Application Circuits (continued)

1+1 Phase Configuration without I²C

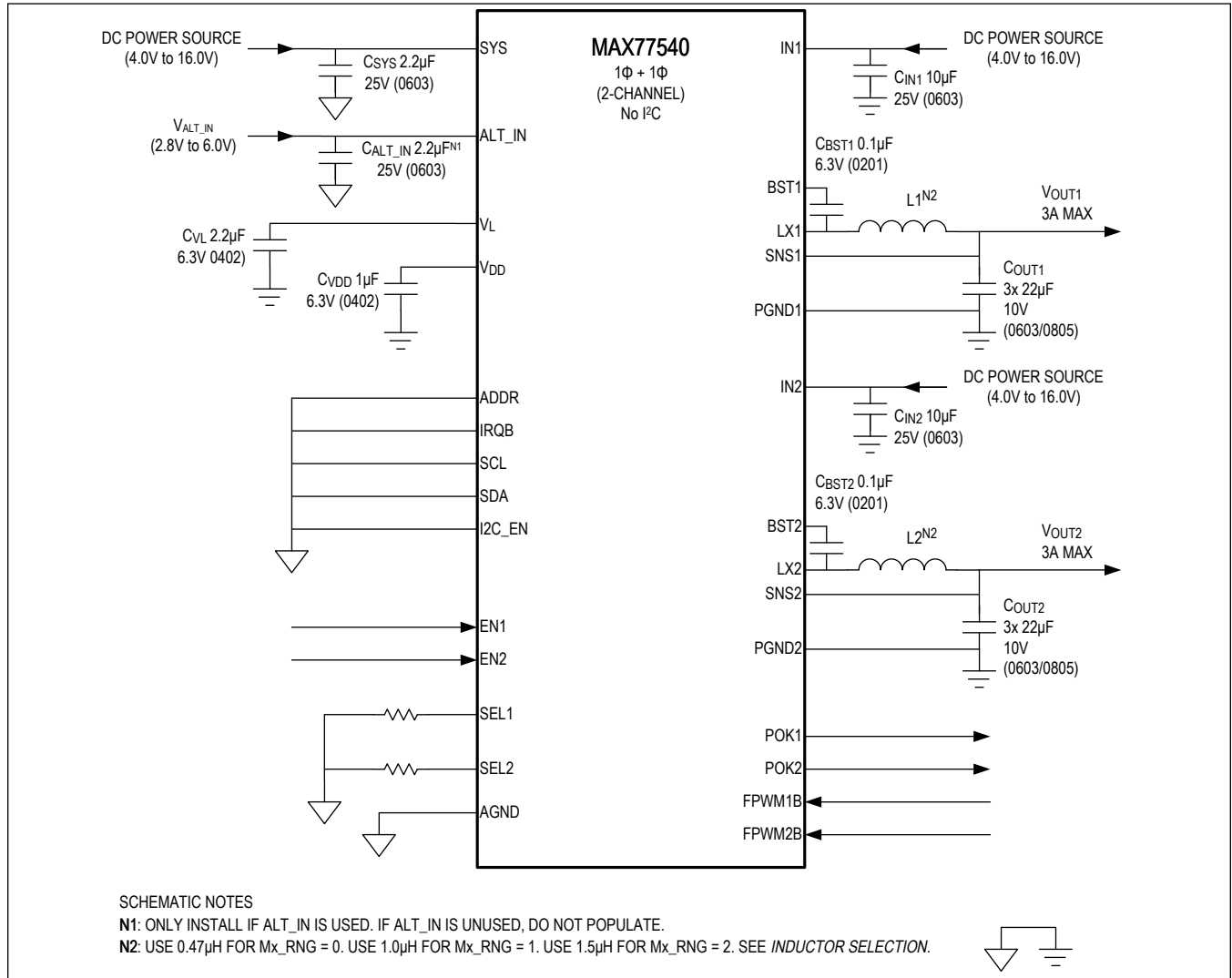

Typical Application Circuits (continued)

Dual-Phase Configuration with I²C Enabled

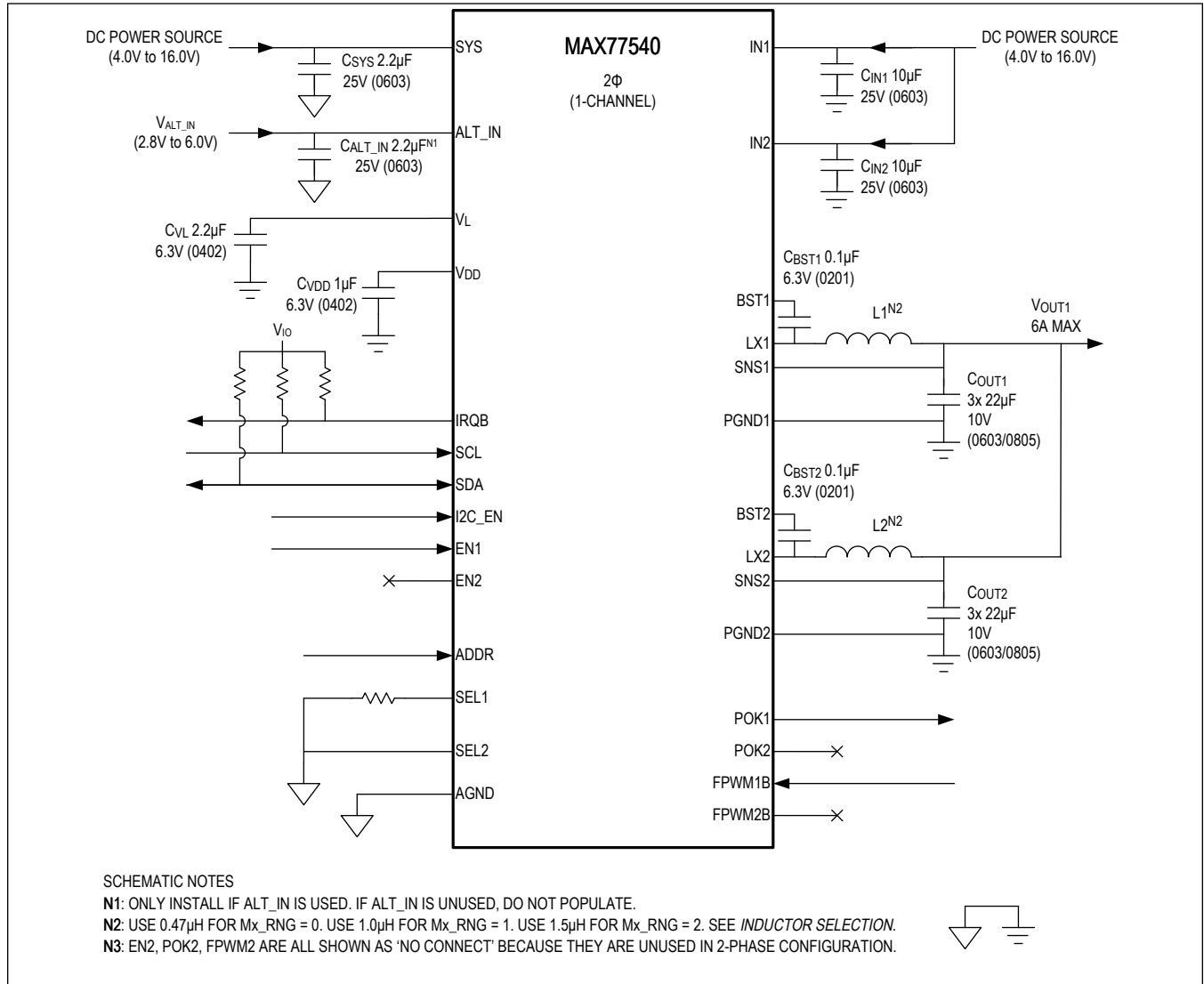

Typical Application Circuits (continued)

Dual-Phase Configuration without I²C

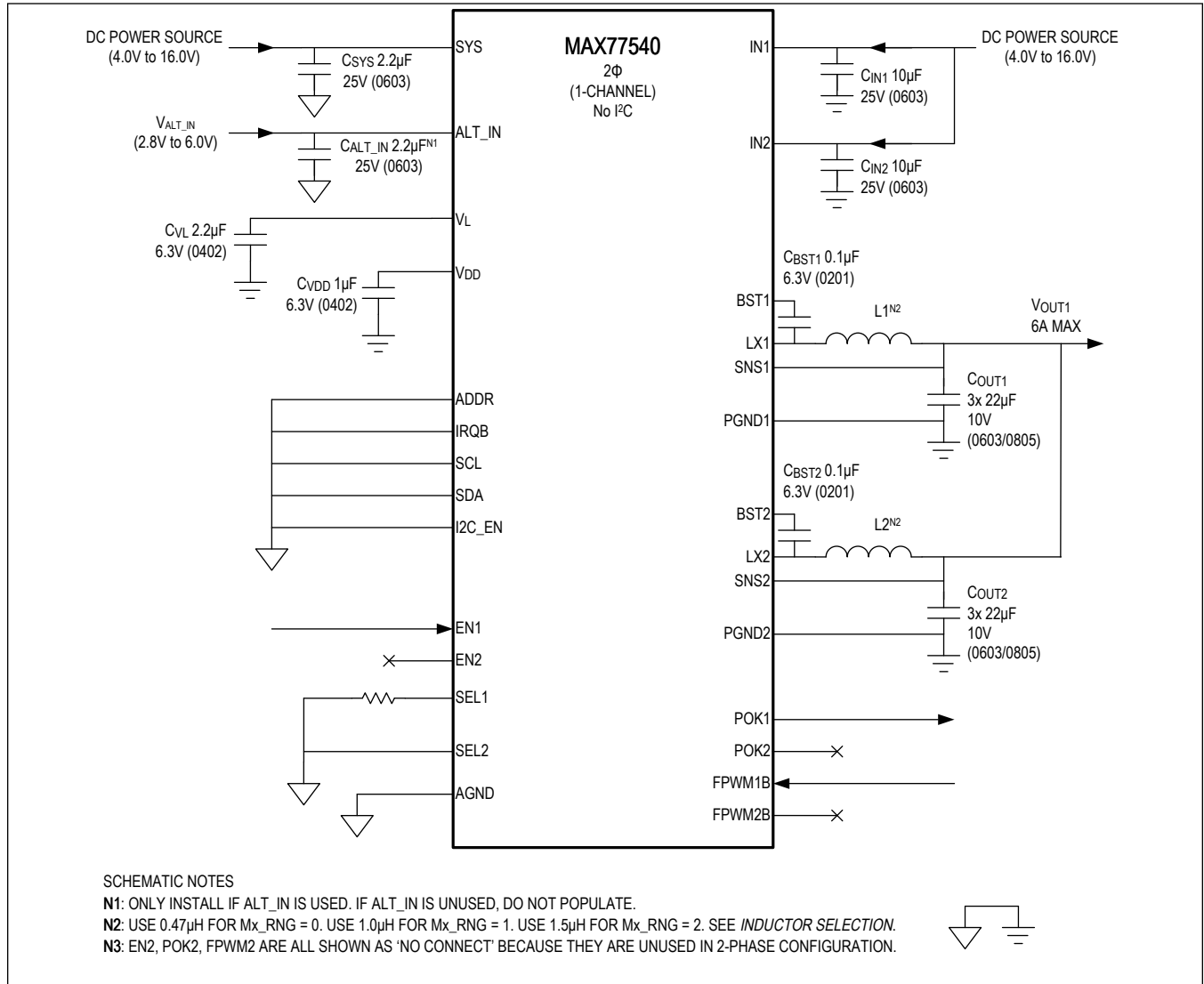

Ordering Information

| PART NUMBER | FACTORY OPTION | PIN-PACKAGE |
|-----------------|----------------|-------------|
| MAX77540AAWV+T | A | 30 WLP |
| MAX77540AAFG+T* | A | 24 FC2QFN |

T = Tape and reel.

* Future product. Contact factory for availability.

MAX77540

16V_{IN}/6A, Dual-Phase High-Efficiency Buck Converter

Revision History

| REVISION NUMBER | REVISION DATE | DESCRIPTION | PAGES CHANGED |
|-----------------|---------------|--------------------------|---------------|
| 0 | 4/21 | Release for market intro | — |

For pricing, delivery, and ordering information, please visit Maxim Integrated's online storefront at <https://www.maximintegrated.com/en/storefront/storefront.html>.

Maxim Integrated cannot assume responsibility for use of any circuitry other than circuitry entirely embodied in a Maxim Integrated product. No circuit patent licenses are implied. Maxim Integrated reserves the right to change the circuitry and specifications without notice at any time. The parametric values (min and max limits) shown in the Electrical Characteristics table are guaranteed. Other parametric values quoted in this data sheet are provided for guidance.