

FEATURES

- Fully integrated single-lead ECG front end
- Low supply current: 170 μ A (typical)
- Common-mode rejection ratio: 80 dB (dc to 60 Hz)
- Two or three electrode configurations
- High signal gain ($G = 100$) with dc blocking capabilities
- 2-pole adjustable high-pass filter
- Accepts up to ± 300 mV of half cell potential
- Fast restore feature improves filter settling
- Uncommitted op amp
- 3-pole adjustable low-pass filter with adjustable gain
- Leads off detection: ac or dc options
- Integrated right leg drive (RLD) amplifier
- Single-supply operation: 2.0 V to 3.5 V
- Integrated reference buffer generates virtual ground
- Rail-to-rail output
- Internal RFI filter
- 8 kV HBM ESD rating
- Shutdown pin
- 20-lead, 4 mm \times 4 mm LFCSP and LFCSP_SS package
- Qualified for automotive applications

APPLICATIONS

- Fitness and activity heart rate monitors
- Portable ECG
- Remote health monitors
- Gaming peripherals
- Biopotential signal acquisition

GENERAL DESCRIPTION

The [AD8232](#) is an integrated signal conditioning block for ECG and other biopotential measurement applications. It is designed to extract, amplify, and filter small biopotential signals in the presence of noisy conditions, such as those created by motion or remote electrode placement. This design allows for an ultralow power analog-to-digital converter (ADC) or an embedded microcontroller to acquire the output signal easily.

The [AD8232](#) can implement a two-pole high-pass filter for eliminating motion artifacts and the electrode half-cell potential. This filter is tightly coupled with the instrumentation architecture of the amplifier to allow both large gain and high-pass filtering in a single stage, thereby saving space and cost.

An uncommitted operational amplifier enables the [AD8232](#) to create a three-pole low-pass filter to remove additional noise. The user can select the frequency cutoff of all filters to suit different types of applications.

FUNCTIONAL BLOCK DIAGRAM

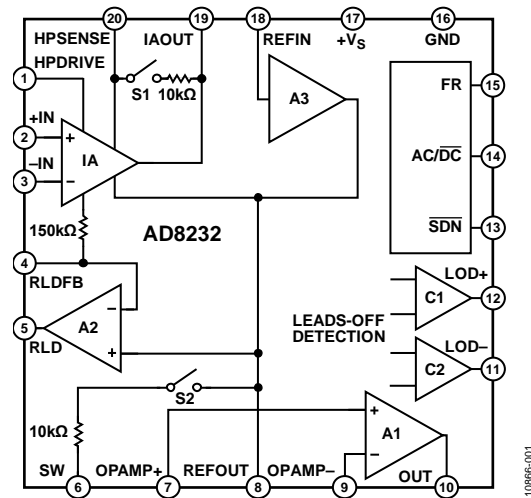

Figure 1.

To improve common-mode rejection of the line frequencies in the system and other undesired interferences, the [AD8232](#) includes an amplifier for driven lead applications, such as right leg drive (RLD).

The [AD8232](#) includes a fast restore function that reduces the duration of otherwise long settling tails of the high-pass filters. After an abrupt signal change that rails the amplifier (such as a leads off condition), the [AD8232](#) automatically adjusts to a higher filter cutoff. This feature allows the [AD8232](#) to recover quickly, and therefore, to take valid measurements soon after connecting the electrodes to the subject.

The [AD8232](#) is available in a 4 mm \times 4 mm, 20-lead LFCSP and a LFCSP_SS package. Performance for the A grade models is specified from 0°C to 70°C and the models are operational from -40°C to $+85^{\circ}\text{C}$. Performance for the W grade models is specified over the automotive temperature range of -40°C to $+105^{\circ}\text{C}$.

Rev. D

Document Feedback

Information furnished by Analog Devices is believed to be accurate and reliable. However, no responsibility is assumed by Analog Devices for its use, nor for any infringements of patents or other rights of third parties that may result from its use. Specifications subject to change without notice. No license is granted by implication or otherwise under any patent or patent rights of Analog Devices. Trademarks and registered trademarks are the property of their respective owners.

TABLE OF CONTENTS

Features	1	Standby Operation	21
Applications	1	Input Protection	21
Functional Block Diagram	1	Radio Frequency Interference (RFI)	22
General Description	1	Power Supply Regulation and Bypassing.....	22
Revision History	2	Input Referred Offsets	22
Specifications	4	Layout Recommendations	22
Absolute Maximum Ratings	7	Applications Information	23
ESD Caution.....	7	Eliminating Electrode Offsets.....	23
Pin Configuration and Function Descriptions	8	High-Pass Filtering	23
Typical Performance Characteristics.....	9	Low-Pass Filtering and Gain	26
Instrumentation Amplifier Performance Curves	9	Driving Analog-to-Digital Converters.....	26
Operational Amplifier Performance Curves	12	Driven Electrode	26
Right Leg Drive (RLD) Amplifier Performance Curves	15	Application Circuits.....	27
Reference Buffer Performance Curves	16	Heart Rate Measurement Next to the Heart	27
System Performance Curves	17	Exercise Application: Heart Rate Measured at the Hands ...	27
Theory of Operation	18	Cardiac Monitor Configuration.....	28
Architecture Overview	18	Portable Cardiac Monitor with Elimination of Motion	
Instrumentation Amplifier	18	Artifacts	28
Operational Amplifier	18	Packaging and Ordering Information.....	30
Right Leg Drive Amplifier.....	19	Outline Dimensions.....	30
Reference Buffer	19	Ordering Guide	31
Fast Restore Circuit.....	19		
Leads Off Detection	20		

REVISION HISTORY

3/2020—Rev. C to Rev. D

Added LFCSP_SS Package	Throughout
Changes to Features Section and General Description Section	1
Changes to Specifications Section and Table 1	4
Changes to Operating Temperature Range Parameter, Table 2.....	7
Changes to Figure 16 to Figure 20	11
Changes to Figure 29	13
Changes to Figure 32 and Figure 33	14
Changes to Figure 35	15
Changes to Figure 42	16
Changes to Figure 43 and Figure 44	17
Changes to Figure 45	18
Added Figure 70	30
Changes to Ordering Guide.....	31

6/2018—Rev. B to Rev. C

Changes to Figure 24	10
Changes to Radio Frequency Interference (RFI) Section	20
Updated Outline Dimensions.....	27

3/2017—Rev. A to Rev. B

Updated Outline Dimensions	27
Changes to Ordering Guide.....	27

2/2013—Rev. 0 to Rev. A

Changes to Table 1	4
Changes to Table 2	6
Change to Figure 17	9
Changes to Figure 22 and Figure 25	11
Changes to Figure 34 and Figure 36	14
Changes to Figure 45, Architecture Overview Section, and Instrumentation Amplifier Section	17
Changes to Right Leg Drive Amplifier Section, Reference Buffer Section, Fast Restore Circuit Section, and Figure 48; Added Figure 46, Renumbered Sequentially.....	18
Changes to Figure 49	19
Changes to AC Leads Off Detection Section and Standby Operation Section.....	20
Changes to Input Referred Offsets Section.....	21
Changes to Figure 53 and High-Pass Filtering Section	22

Changes to Additional High-Pass Filtering Options Section;
Added Table 4.....23
Changes to Low-Pass Filtering and Gain Section; Added Driving
Analog-to-Digital Converters Section and Figure 6124
Changes to Figure 62, Figure 64, and Heart Rate Measurement
Next to the Heart Section.....25

Changes to Exercise Application: Heart Rate Measured at the
Hands and Figure 6626
Changes to Figure 68.....27

8/2012—Revision 0: Initial Version

SPECIFICATIONS

$V_S = 3\text{ V}$, $V_{REF} = 1.5\text{ V}$, $V_{CM} = 1.5\text{ V}$, $T_A = 25^\circ\text{C}$, operating temperature (T_{OPR}) = -40°C to $+105^\circ\text{C}$ for the W grade, FR = low, SDN = high, and AC/DC = low, unless otherwise noted.

Table 1.

Parameter	Symbol	Test Conditions/ Comments	A Grade			W Grade			Unit
			Min	Typ	Max	Min	Typ	Max	
INSTRUMENTATION AMPLIFIER									
Common-Mode Rejection Ratio, DC to 60 Hz	CMRR	$V_{CM} = 0.35\text{ V to }2.85\text{ V}$, $V_{DIFF} = 0\text{ V}$	80	86					dB
		T_{OPR}				80			dB
		$V_{CM} = 0.35\text{ V to }2.85\text{ V}$, $V_{DIFF} = \pm 0.3\text{ V}$		80			80		dB
Power Supply Rejection Ratio	PSRR	$V_S = 2.0\text{ V to }3.5\text{ V}$ T_{OPR}	76	90		76	90		dB dB
Offset Voltage (RTI) Instrumentation Amplifier Inputs	V_{OS}	T_{OPR}		3	8				mV mV
		DC Blocking Input ¹		5	50		5	50	μV
		Average Offset Drift Instrumentation Amplifier Inputs		10					$\mu\text{V}/^\circ\text{C}$ $\mu\text{V}/^\circ\text{C}$
DC Blocking Input ¹ Input Bias Current	I_B	T_{OPR}		0.05			0.05		$\mu\text{V}/^\circ\text{C}$ $\mu\text{V}/^\circ\text{C}$
		$T_A = 0^\circ\text{C to }70^\circ\text{C}$		50	200		50	200	pA nA
Input Offset Current	I_{OS}	T_{OPR}		1				3.75	nA nA
		$T_A = 0^\circ\text{C to }70^\circ\text{C}$		25	100		25	100	pA nA
Input Impedance Differential Common Mode		T_{OPR}						1	nA nA
		$T_A = 0^\circ\text{C to }70^\circ\text{C}$		1					nA nA
Input Voltage Noise (RTI) Spectral Noise Density Peak-to-Peak Voltage Noise		$f = 1\text{ kHz}$		100			100		nV/ $\sqrt{\text{Hz}}$
		$f = 0.1\text{ Hz to }10\text{ Hz}$		12			12		$\mu\text{V p-p}$
		$f = 0.5\text{ Hz to }40\text{ Hz}$		14			14		$\mu\text{V p-p}$
Input Voltage Range		$T_A = 0^\circ\text{C to }70^\circ\text{C}$	0.2		$+V_S$				V V
		T_{OPR}				0.2		$+V_S$	V mV
DC Differential Input Range	V_{DIFF}	T_{OPR}	-300		+300				mV mV
		T_{OPR}				-300		+300	mV
Output Output Swing		$R_L = 50\text{ k}\Omega$	0.1		$+V_S - 0.1$				V V
		T_{OPR}				0.1		$+V_S - 0.1$	V V
Short-Circuit Current	I_{OUT}		6.3			6.3			mA
Gain Gain Error	A_V	$V_{DIFF} = 0\text{ V}$		100			100		V/V
		$V_{DIFF} = -300\text{ mV to }+300\text{ mV}$		0.4	3.5		0.4		% %
Average Gain Drift		T_{OPR}					7.9		% %
		$T_A = 0^\circ\text{C to }70^\circ\text{C}$		12					ppm/ $^\circ\text{C}$ ppm/ $^\circ\text{C}$
Bandwidth	BW	T_{OPR}		2			12		kHz
RFI Filter Cutoff (Each Input)				1			1		MHz

Parameter	Symbol	Test Conditions/ Comments	A Grade			W Grade			Unit
			Min	Typ	Max	Min	Typ	Max	
OPERATIONAL AMPLIFIER (A1)									
Offset Voltage	V_{OS}			1	5				mV
Average TC		T_{OPR} $T_A = 0^\circ\text{C to } 70^\circ\text{C}$		5		1	5		mV
		T_{OPR}				5			$\mu\text{V}/^\circ\text{C}$
Input Bias Current	I_B	$T_A = 0^\circ\text{C to } 70^\circ\text{C}$		100		100			$\mu\text{V}/^\circ\text{C}$
		T_{OPR}		1					pA
Input Offset Current	I_{OS}	$T_A = 0^\circ\text{C to } 70^\circ\text{C}$				2.5			nA
		T_{OPR}		100		100			nA
		$T_A = 0^\circ\text{C to } 70^\circ\text{C}$		1					pA
		T_{OPR}				1			nA
Input Voltage Range			0.1		$+V_S - 0.1$	0.1		$+V_S - 0.1$	V
Common-Mode Rejection Ratio	CMRR	$V_{CM} = 0.5\text{ V to } 2.5\text{ V}$		100		100			dB
Power Supply Rejection Ratio	PSRR			100		100			dB
Large Signal Voltage Gain	A_{VO}			110		110			dB
Output Voltage Range		$R_L = 50\text{ k}\Omega$	0.1		$+V_S - 0.1$				V
		T_{OPR}				0.1		$+V_S - 0.1$	V
Short-Circuit Current Limit	I_{OUT}			12		12			mA
Gain Bandwidth Product	GBP			100		100			kHz
Slew Rate	SR			0.02		0.02			V/ μs
Voltage Noise Density (RTI)	e_n	$f = 1\text{ kHz}$		60		60			nV/ $\sqrt{\text{Hz}}$
Peak-to-Peak Voltage Noise (RTI)	$e_{n\text{-p-p}}$	$f = 0.1\text{ Hz to } 10\text{ Hz}$		6		6			$\mu\text{V p-p}$
		$f = 0.5\text{ Hz to } 40\text{ Hz}$		8		8			$\mu\text{V p-p}$
RIGHT LEG DRIVE AMPLIFIER (A2)									
Output Swing		$R_L = 50\text{ k}\Omega$	0.1		$+V_S - 0.1$	0.1		$+V_S - 0.1$	V
Short-Circuit Current	I_{OUT}			11		11			mA
Integrator Input Resistor			120	150	180	120	150	180	k Ω
Gain Bandwidth Product	GDP			100		100			kHz
REFERENCE BUFFER (A3)									
Offset Error	V_{OS}	$R_L > 50\text{ k}\Omega$		1		1			mV
Input Bias Current	I_B			100		100			pA
Short-Circuit Current Limit	I_{OUT}			12		12			mA
Voltage Range		$R_L = 50\text{ k}\Omega$	0.1		$+V_S - 0.7$				V
		T_{OPR}				0.1		$+V_S - 0.7$	V
DC LEADS OFF COMPARATORS									
Threshold Voltage					$+V_S - 0.5$			$+V_S - 0.5$	V
Hysteresis				60		60			mV
Propagation Delay				0.5		0.5			μs
AC LEADS OFF DETECTOR									
Square Wave Frequency	f_{AC}		50	100	175	50	100	175	kHz
Square Wave Amplitude	I_{AC}			200		200			nA p-p
Impedance Threshold		Between +IN and -IN	10	20		10	20		M Ω
Detection Delay				110		110			μs
FAST RESTORE CIRCUIT									
Switches		S1 and S2							
On Resistance	R_{ON}		8	10	12	8	10	12	k Ω
Off Leakage				100		100			pA
Window Comparator									
Threshold Voltage		From either rail		50		50			mV
Propagation Delay				2		2			μs
Switch Timing Characteristics									
Feedback Recovery Switch On Time	t_{SW1}			110		110			ms
Filter Recovery Switch On Time	t_{SW2}			55		55			ms
Fast Restore Reset	t_{RST}			2		2			μs

Parameter	Symbol	Test Conditions/ Comments	A Grade			W Grade			Unit
			Min	Typ	Max	Min	Typ	Max	
LOGIC INTERFACE									
Input Characteristics									
Input Voltage ($\overline{AC/DC}$ and FR)									
Low	V_{IL}			1.24			1.24		V
High	V_{IH}			1.35			1.35		V
Input Voltage (\overline{SDN})									
Low	V_{IL}			2.1			2.1		V
High	V_{IH}			0.5			0.5		V
Output Characteristics									
Output Voltage									
Low	V_{OL}	LOD+ and LOD- terminals		0.05			0.05		V
High	V_{OH}			2.95			2.95		V
SYSTEM SPECIFICATIONS									
Quiescent Supply Current									
		$T_A = 0^\circ\text{C to } 70^\circ\text{C}$		170	230		170	230	μA
		T_{OPR}		210				270	μA
Shutdown Current									
		$T_A = 0^\circ\text{C to } 70^\circ\text{C}$		40	500		40	500	nA
		T_{OPR}		100				612	nA
Supply Range									
			2.0		3.5	2.0		3.5	V
Specified Temperature Range									
			0		+70	-40		+105	$^\circ\text{C}$
Operational Temperature Range									
			-40		+85	-40		+105	$^\circ\text{C}$

¹ Offset referred to the input of the instrumentation amplifier inputs. See the Input Referred Offsets section for additional information.

ABSOLUTE MAXIMUM RATINGS

Table 2.

Parameter	Rating
Supply Voltage	3.6 V
Output Short-Circuit Current Duration	Indefinite
Maximum Voltage, Any Terminal ¹	+V _S + 0.3 V
Minimum Voltage, Any Terminal ¹	−0.3 V
Storage Temperature Range	−65°C to +125°C
Operating Temperature Range	
AD8232ACPZ	−40°C to +85°C
AD8232WACSZ	−40°C to +105°C
Maximum Junction Temperature	140°C
θ _{JA} Thermal Impedance ²	48°C/W
θ _{JC} Thermal Impedance	4.4°C/W
ESD Rating	
Human Body Model (HBM)	8 kV
Charged Device Model (FICDM)	1.25 kV
Machine Model (MM)	200 V

¹ This level or the maximum specified supply voltage, whichever is the lesser, indicates the superior voltage limit for any terminal. If input voltages beyond the specified minimum or maximum voltages are expected, place resistors in series with the inputs to limit the current to less than 5 mA.

² θ_{JA} is specified for a device in free air on a 4-layer JEDEC board.

Stresses at or above those listed under Absolute Maximum Ratings may cause permanent damage to the product. This is a stress rating only; functional operation of the product at these or any other conditions above those indicated in the operational section of this specification is not implied. Operation beyond the maximum operating conditions for extended periods may affect product reliability.

ESD CAUTION



ESD (electrostatic discharge) sensitive device. Charged devices and circuit boards can discharge without detection. Although this product features patented or proprietary protection circuitry, damage may occur on devices subjected to high energy ESD. Therefore, proper ESD precautions should be taken to avoid performance degradation or loss of functionality.

PIN CONFIGURATION AND FUNCTION DESCRIPTIONS

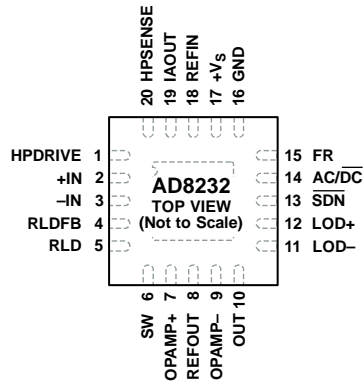

NOTES
1. CONNECT THE EXPOSED PAD TO GND OR LEAVE UNCONNECTED.

10866-002

Figure 2. Pin Configuration

Table 3. Pin Function Descriptions

Pin No.	Mnemonic	Description
1	HPDRIVE	High-Pass Driver Output. Connect HPDRIVE to the capacitor in the first high-pass filter. The AD8232 drives this pin to keep HPSENSE at the same level as the reference voltage.
2	+IN	Instrumentation Amplifier Positive Input. +IN is typically connected to the left arm (LA) electrode.
3	-IN	Instrumentation Amplifier Negative Input. -IN is typically connected to the right arm (RA) electrode.
4	RLDFB	Right Leg Drive Feedback Input. RLDFB is the feedback terminal for the right leg drive circuit.
5	RLD	Right Leg Drive Output. Connect the driven electrode (typically, right leg) to the RLD pin.
6	SW	Fast Restore Switch Terminal. Connect this terminal to the output of the second high-pass filter.
7	OPAMP+	Operational Amplifier Noninverting Input.
8	REFOUT	Reference Buffer Output. The instrumentation amplifier output is referenced to this potential. Use REFOUT as a virtual ground for any point in the circuit that needs a signal reference.
9	OPAMP-	Operational Amplifier Inverting Input.
10	OUT	Operational Amplifier Output. The fully conditioned heart rate signal is present at this output. OUT can be connected to the input of an ADC.
11	LOD-	Leads Off Comparator Output. In dc leads off detection mode, LOD- is high when the electrode to -IN is disconnected, and it is low when connected. In ac leads off detection mode, LOD- is always low.
12	LOD+	Leads Off Comparator Output. In dc leads off detection mode, LOD+ is high when the +IN electrode is disconnected, and it is low when connected. In ac leads off detection mode, LOD+ is high when either the -IN or +IN electrode is disconnected, and it is low when both electrodes are connected.
13	$\overline{\text{SDN}}$	Shutdown Control Input. Drive $\overline{\text{SDN}}$ low to enter the low power shutdown mode.
14	$\overline{\text{AC/DC}}$	Leads Off Mode Control Input. Drive the $\overline{\text{AC/DC}}$ pin low for dc leads off mode. Drive the $\overline{\text{AC/DC}}$ pin high for ac leads off mode.
15	FR	Fast Restore Control Input. Drive FR high to enable fast recovery mode; otherwise, drive it low.
16	GND	Power Supply Ground.
17	+Vs	Power Supply Terminal.
18	REFIN	Reference Buffer Input. Use REFIN, a high impedance input terminal, to set the level of the reference buffer.
19	IAOUT	Instrumentation Amplifier Output Terminal.
20	HPSENSE	High-Pass Sense Input for Instrumentation Amplifier. Connect HPSENSE to the junction of R and C that sets the corner frequency of the dc blocking circuit.
	EP	Exposed Pad. Connect the exposed pad to GND or leave it unconnected.

TYPICAL PERFORMANCE CHARACTERISTICS

$V_S = 3\text{ V}$, $V_{REF} = 1.5\text{ V}$, $V_{CM} = 1.5\text{ V}$, $T_A = 25^\circ\text{C}$, unless otherwise noted.

INSTRUMENTATION AMPLIFIER PERFORMANCE CURVES

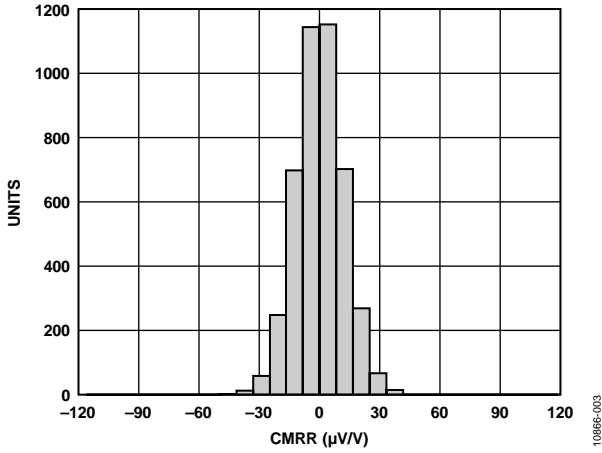

Figure 3. Instrumentation Amplifier CMRR Distribution

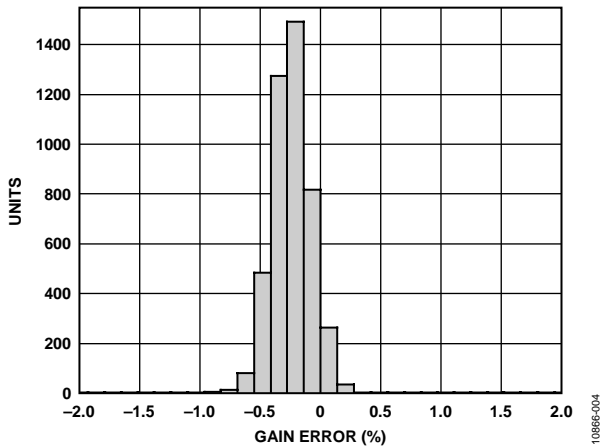

Figure 4. Instrumentation Amplifier Gain Error Distribution

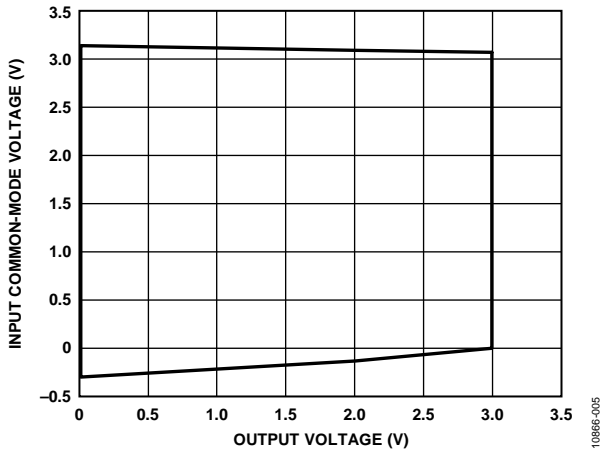

Figure 5. Instrumentation Amplifier Input Common-Mode Range vs. Output Voltage

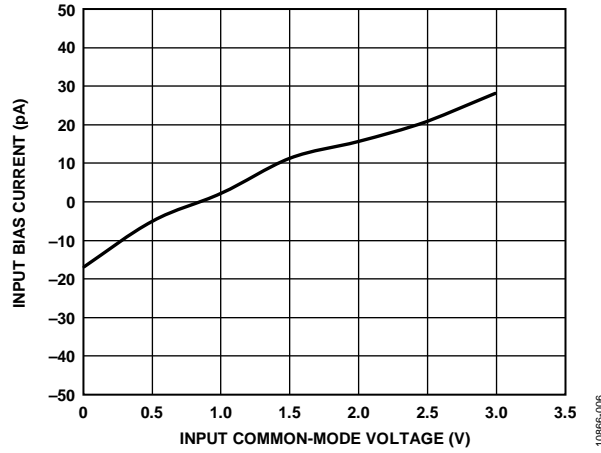

Figure 6. Instrumentation Amplifier Input Bias Current vs. CMV

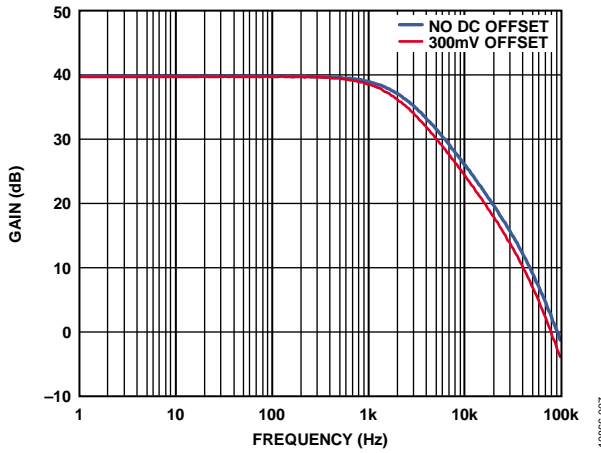

Figure 7. Instrumentation Amplifier Gain vs. Frequency

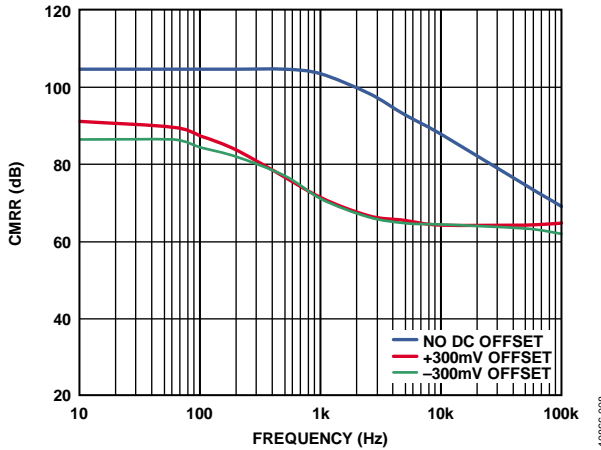

Figure 8. Instrumentation Amplifier CMRR vs. Frequency, RTI

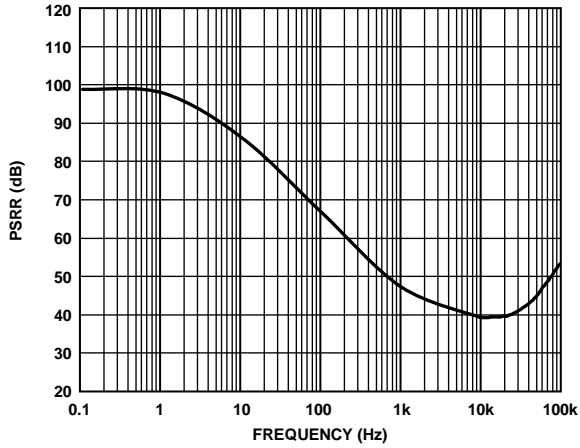

Figure 9. Instrumentation Amplifier PSRR vs. Frequency

10866-009

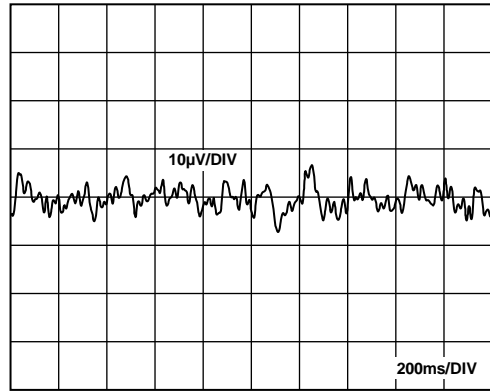

Figure 12. Instrumentation Amplifier 0.5 Hz to 40 Hz Noise

10866-012

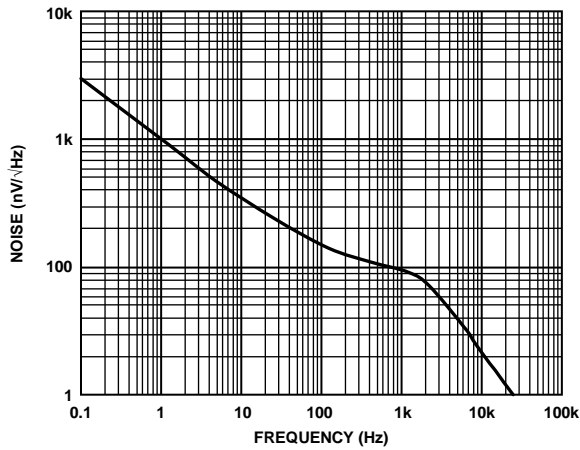

Figure 10. Instrumentation Amplifier Voltage Noise Spectral Density (RTI)

10866-010

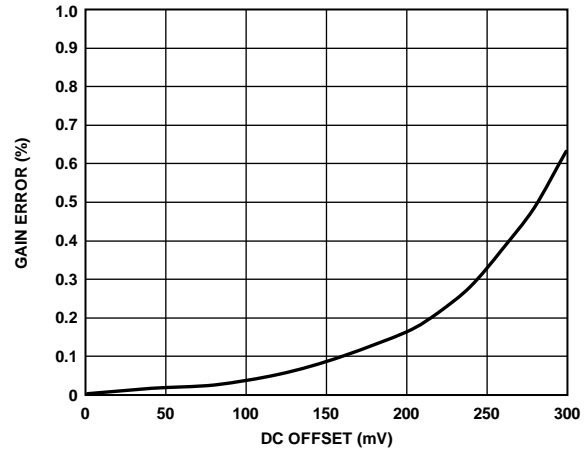

Figure 13. Instrumentation Amplifier Gain Error vs. DC Offset

10866-013

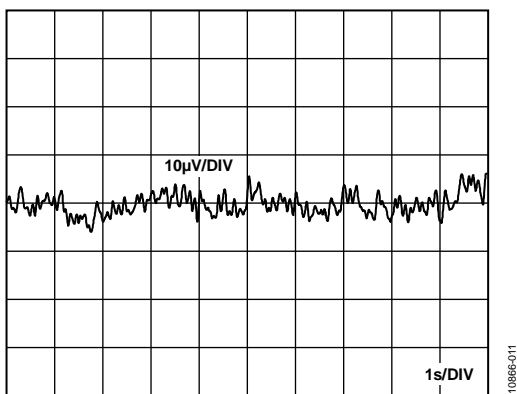

Figure 11. Instrumentation Amplifier 0.1 Hz to 10 Hz Noise

10866-011

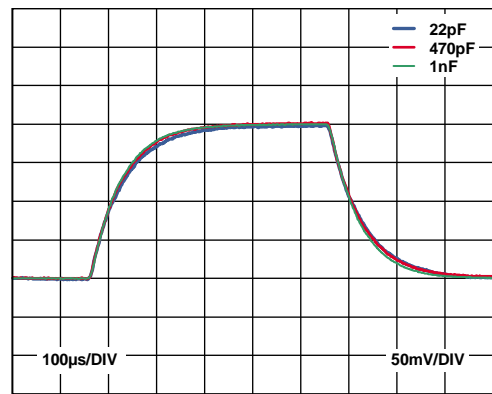

Figure 14. Instrumentation Amplifier Small Signal Pulse Response

10866-014

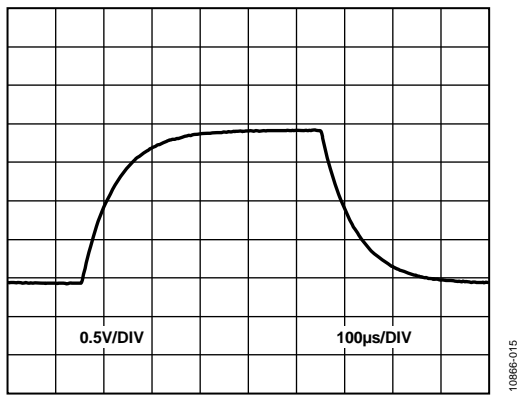

Figure 15. Instrumentation Amplifier Large Signal Pulse Response

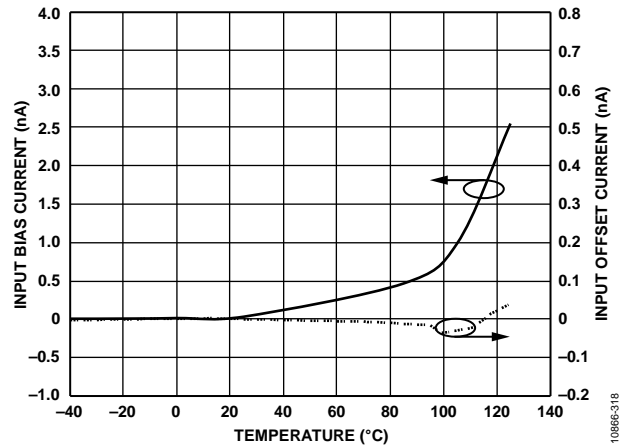

Figure 18. Instrumentation Amplifier Input Bias Current and Input Offset Current vs. Temperature

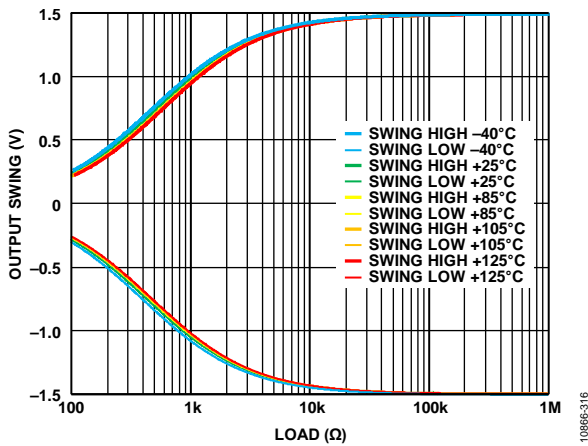

Figure 16. Instrumentation Amplifier Output Swing vs. Load

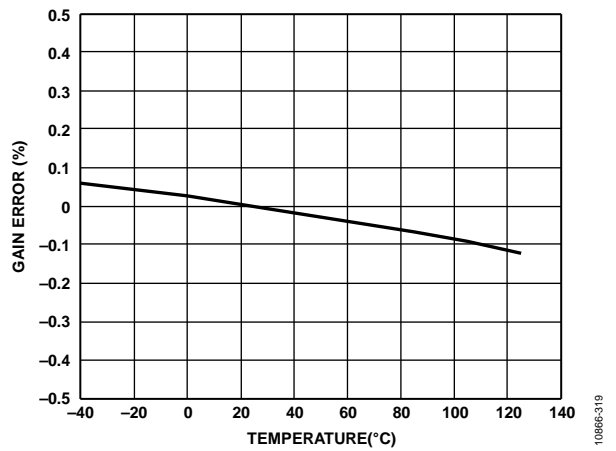

Figure 19. Instrumentation Amplifier Gain Error vs. Temperature

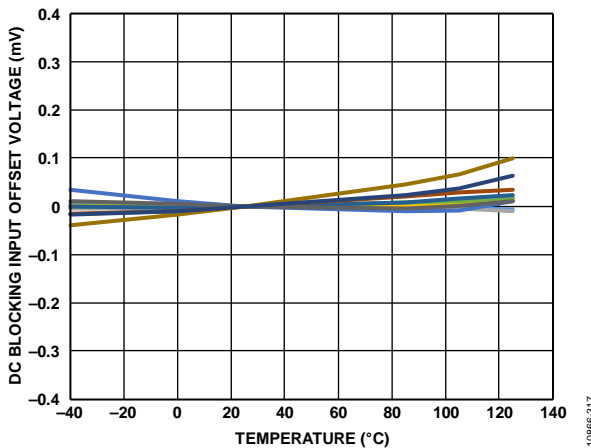

Figure 17. Instrumentation Amplifier DC Blocking Input Offset Drift

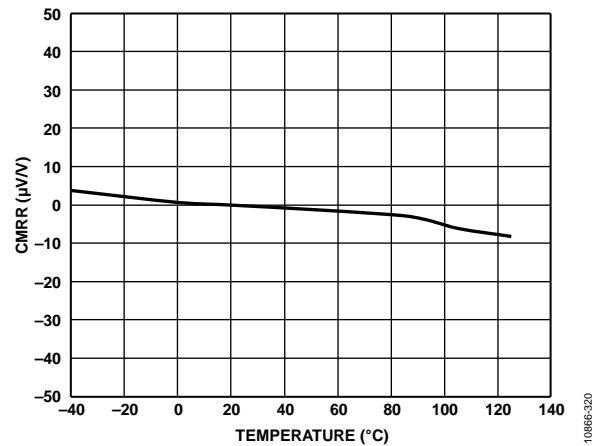

Figure 20. Instrumentation Amplifier CMRR vs. Temperature

OPERATIONAL AMPLIFIER PERFORMANCE CURVES

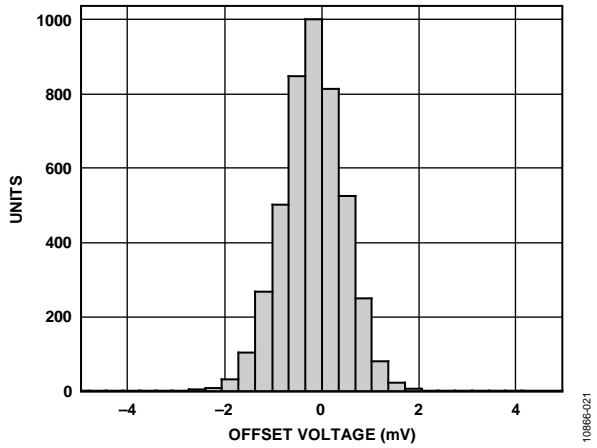

Figure 21. Operational Amplifier Offset Distribution

10886-021

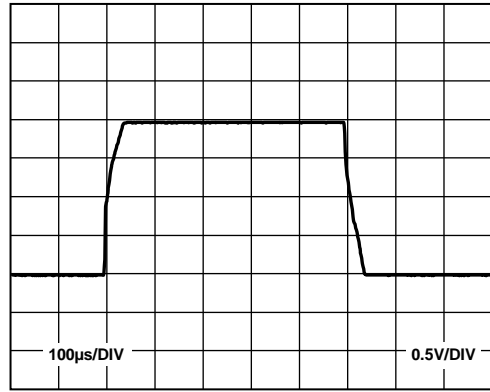

Figure 24. Operational Amplifier Large Signal Transient Response

10886-024

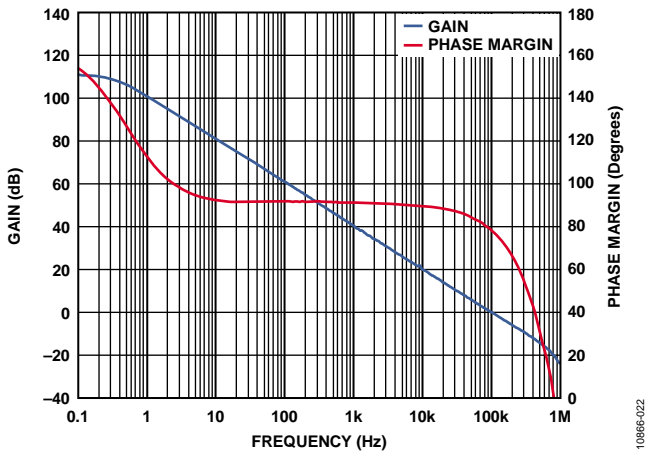

Figure 22. Operational Amplifier Open-Loop Gain and Phase vs. Frequency

10886-022

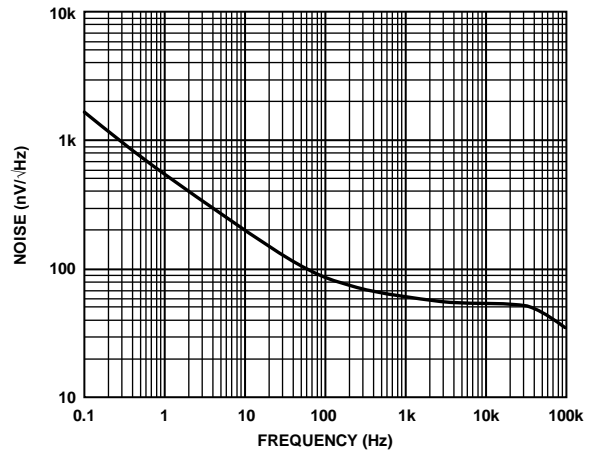

Figure 25. Operational Amplifier Voltage Spectral Noise Density vs. Frequency

10886-025

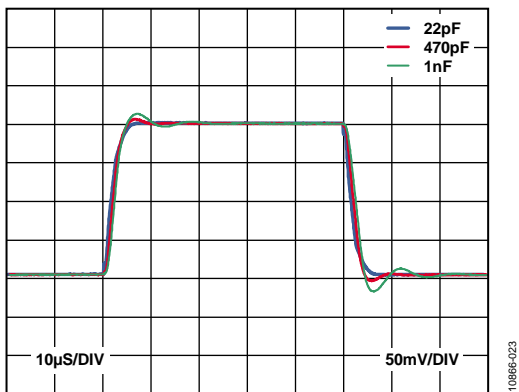

Figure 23. Operational Amplifier Small Signal Response for Various Capacitive Loads

10886-023

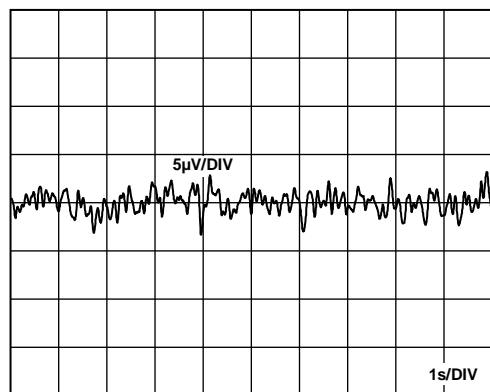

Figure 26. Operational Amplifier 0.1 Hz to 10 Hz Noise

10886-026

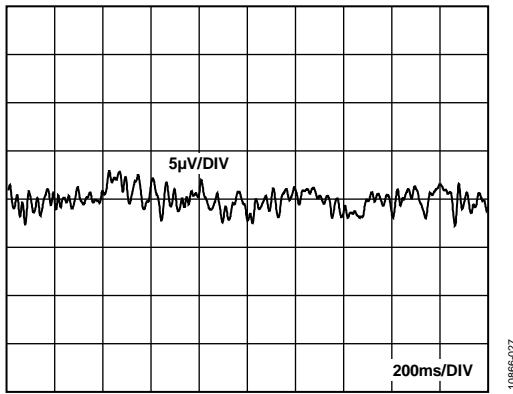

Figure 27. Operational Amplifier 0.5 Hz to 40 Hz Noise

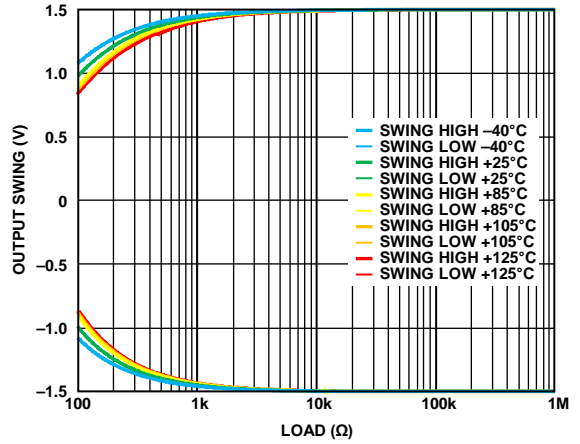

Figure 29. Operational Amplifier Output Voltage Swing vs. Output Current

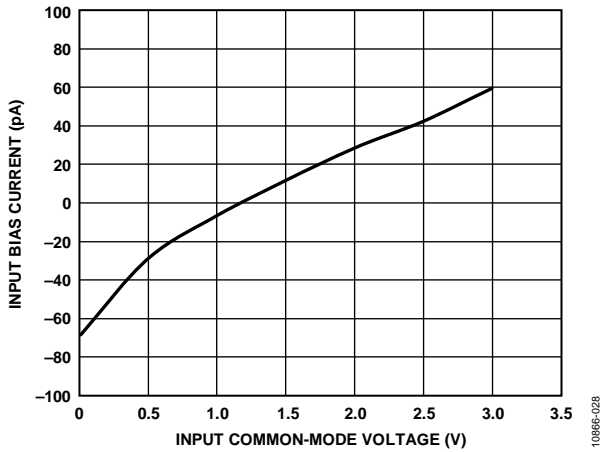

Figure 28. Operational Amplifier Bias Current vs. Input Common-Mode Voltage

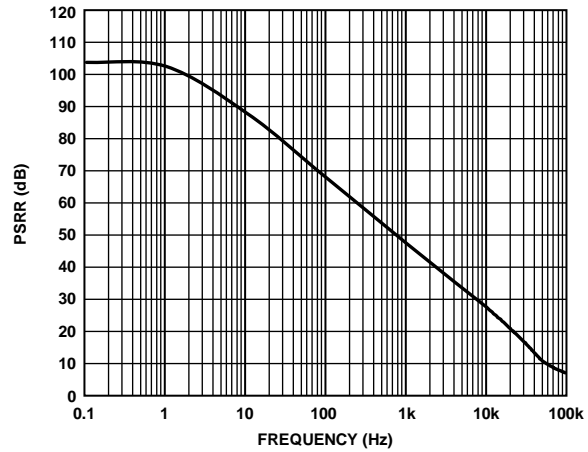

Figure 30. Operational Amplifier Power Supply Rejection Ratio

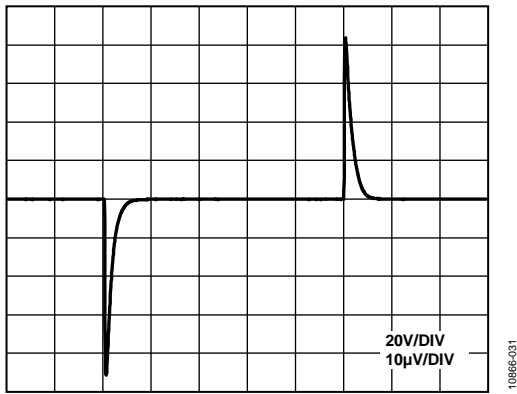

Figure 31. Operational Amplifier Load Transient Response (100 µA Load Change)

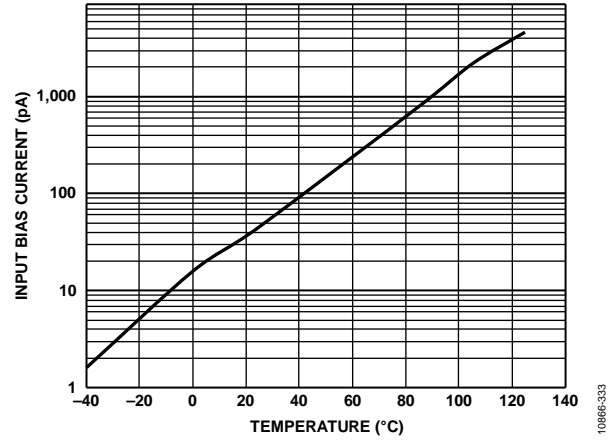

Figure 33. Operational Amplifier Bias Current vs. Temperature

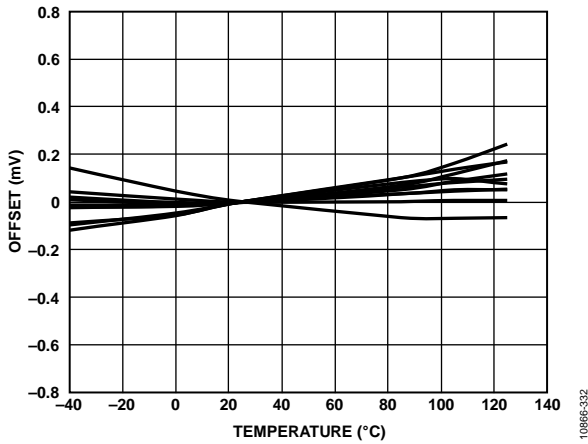

Figure 32. Operational Amplifier Offset vs. Temperature

RIGHT LEG DRIVE (RLD) AMPLIFIER PERFORMANCE CURVES

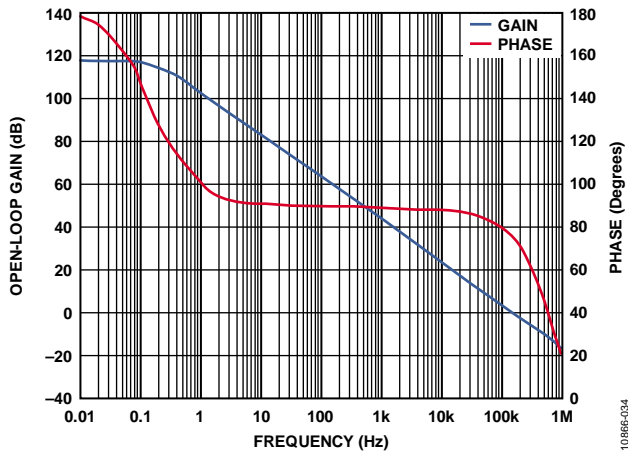

Figure 34. RLD Amplifier Open-Loop Gain and Phase vs. Frequency

1086E-034

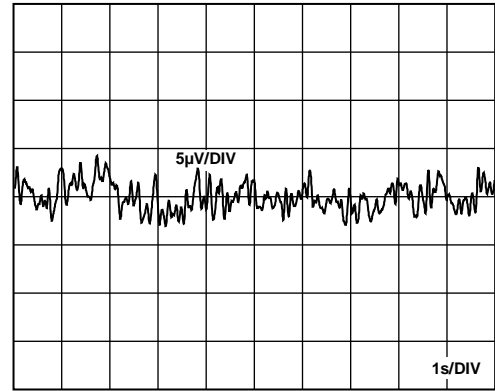

Figure 37. RLD Amplifier 0.1 Hz to 10 Hz Noise

1086E-037

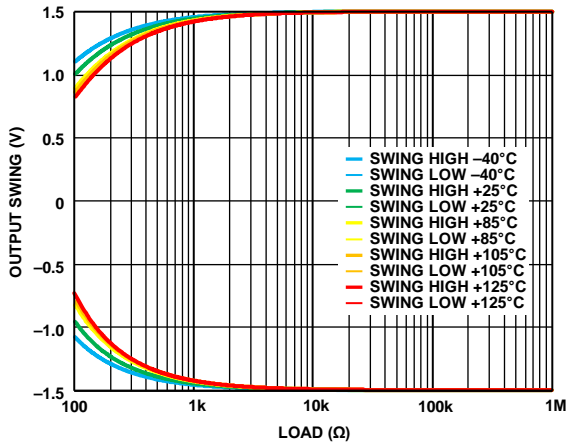

Figure 35. RLD Amplifier Output Voltage Swing vs. Output Current

1086E-335

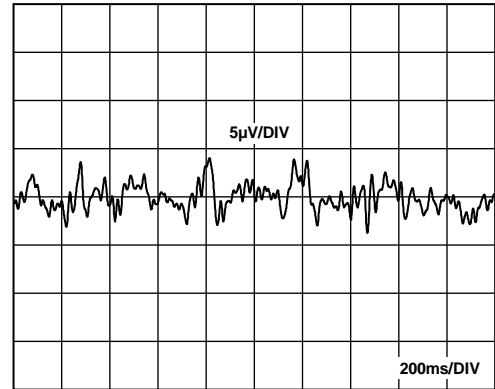

Figure 38. RLD Amplifier 0.5 Hz to 40 Hz Noise

1086E-038

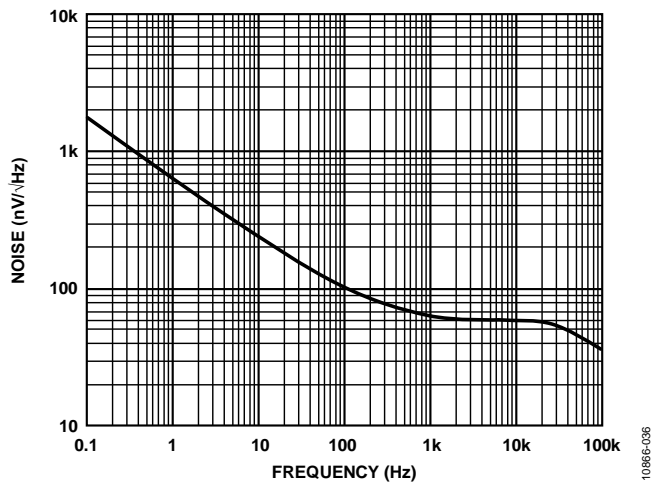

Figure 36. RLD Amplifier Voltage Spectral Noise Density vs. Frequency

1086E-036

REFERENCE BUFFER PERFORMANCE CURVES

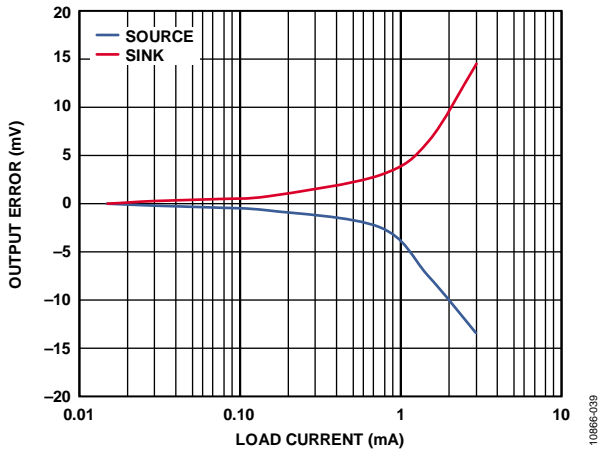

Figure 39. Reference Buffer Load Regulation

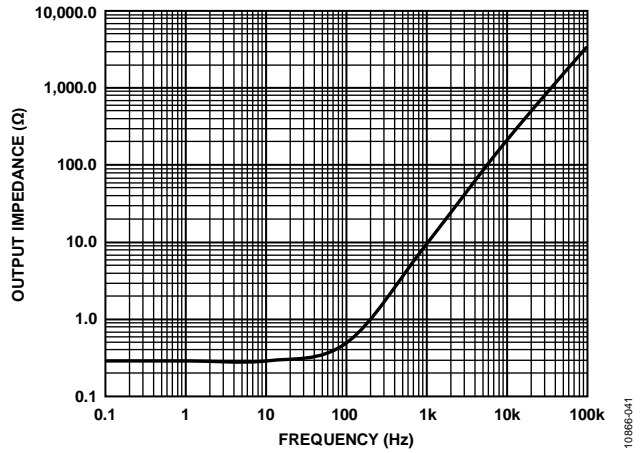

Figure 41. Reference Buffer Output Impedance vs. Frequency

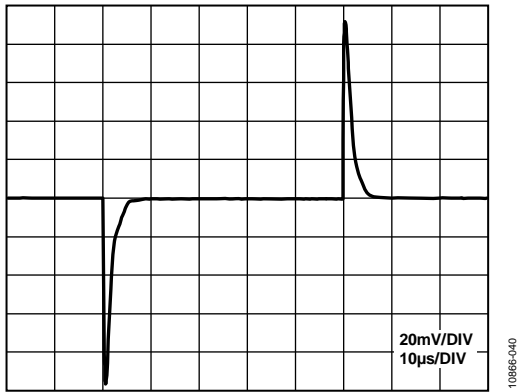

Figure 40. Reference Buffer Load Transient Response (100 μ A Load Change)

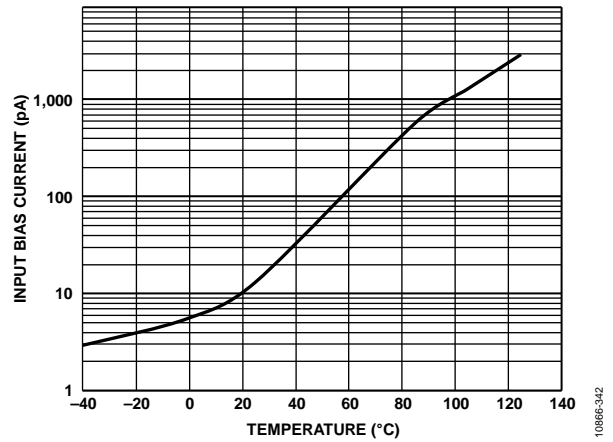

Figure 42. Reference Buffer Bias Current vs. Temperature

SYSTEM PERFORMANCE CURVES

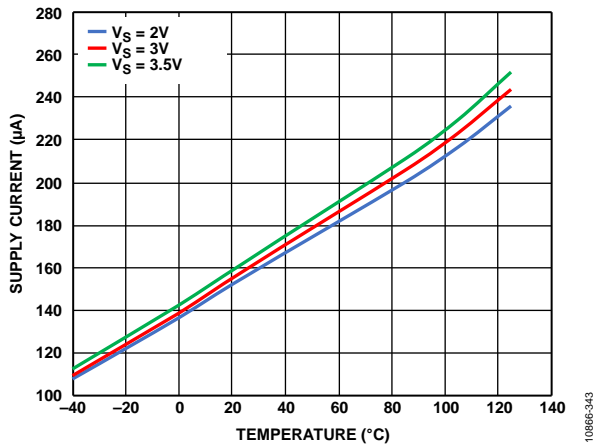

Figure 43. Supply Current vs. Temperature

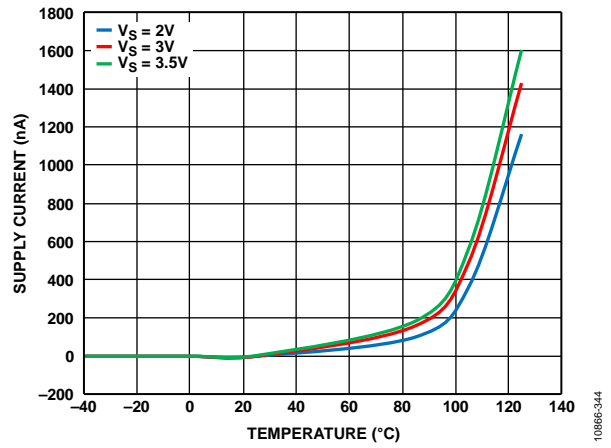
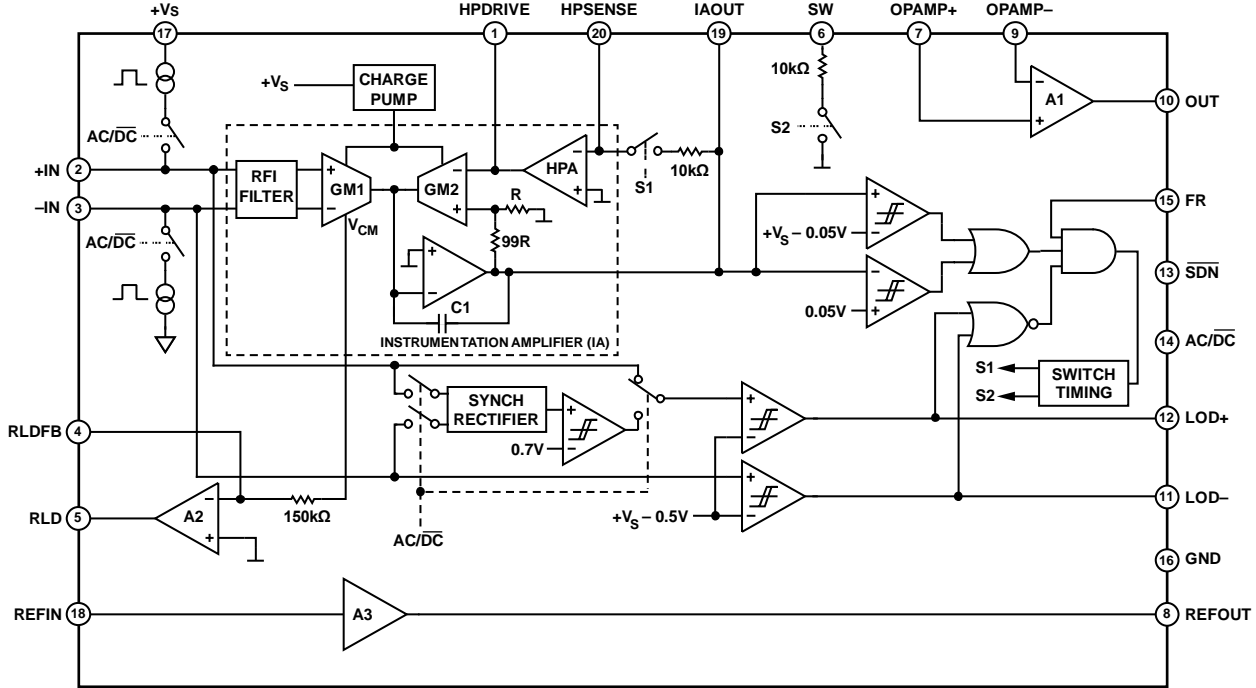

Figure 44. Shutdown Current vs. Temperature

THEORY OF OPERATION



*ALL SWITCHES SHOWN IN DC LEADS-OFF DETECTION POSITION AND FAST RESTORE DISABLED
 ⌊ = REFOUT

Figure 45. Simplified Schematic Diagram

ARCHITECTURE OVERVIEW

The AD8232 is an integrated front end for signal conditioning of cardiac biopotentials for heart rate monitoring. It consists of a specialized instrumentation amplifier (IA), an operational amplifier (A1), a right leg drive amplifier (A2), and a midsupply reference buffer (A3). In addition, the AD8232 includes leads off detection circuitry and an automatic fast restore circuit that brings back the signal shortly after leads are reconnected.

The AD8232 contains a specialized instrumentation amplifier that amplifies the ECG signal while rejecting the electrode half-cell potential on the same stage. This is possible with an indirect current feedback architecture, which reduces size and power compared with traditional implementations.

INSTRUMENTATION AMPLIFIER

The instrumentation amplifier is shown in Figure 45 as comprised by two well-matched transconductance amplifiers (GM1 and GM2), the dc blocking amplifier (HPA), and an integrator formed by C1 and an op amp. The transconductance amplifier, GM1, generates a current that is proportional to the voltage present at its inputs. When the feedback is satisfied, an equal voltage appears across the inputs of the transconductance amplifier, GM2, thereby matching the current generated by GM1. The difference generates an error current that is integrated across Capacitor C1. The resulting voltage appears at the output of the instrumentation amplifier.

The feedback of the amplifier is applied via GM2 through two separate paths: the two resistors divide the output signal to set an overall gain of 100, whereas the dc blocking amplifier integrates any deviation from the reference level. Consequently, dc offsets as large as ± 300 mV across the GM1 inputs appear inverted and with the same magnitude across the inputs of GM2, all without saturating the signal of interest.

To increase the common-mode voltage range of the instrumentation amplifier, a charge pump boosts the supply voltage for the two transconductance amplifiers. This further prevents saturation of the amplifier in the presence of large common-mode signals, such as line interference. The charge pump runs from an internal oscillator, the frequency of which is set around 500 kHz.

OPERATIONAL AMPLIFIER

This general-purpose operational amplifier (A1) is a rail-to-rail device that can be used for low-pass filtering and to add additional gain. The following sections provide details and example circuits that use this amplifier.

RIGHT LEG DRIVE AMPLIFIER

The right leg drive (RLD) amplifier inverts the common-mode signal that is present at the instrumentation amplifier inputs. When the right leg drive output current is injected into the subject, it counteracts common-mode voltage variations, thus improving the common-mode rejection of the system.

The common-mode signal that is present across the inputs of the instrumentation amplifier is derived from the transconductance amplifier, GM1. It is then connected to the inverting input of A2 through a 150 kΩ resistor.

An integrator can be built by connecting a capacitor between the RLD FB and RLD terminals. A good starting point is a 1 nF capacitor, which places the crossover frequency at about 1 kHz (the frequency at which the amplifier has an inverting unity gain). This configuration results in about 26 dB of loop gain available at a frequency range from 50 Hz to 60 Hz for common-mode line rejection. Higher capacitor values reduce the crossover frequency, thereby reducing the gain that is available for rejection and, consequently, increasing the line noise. Lower capacitor values move the crossover frequency to higher frequencies, allowing increased gain. The tradeoff is that with higher gain, the system can become unstable and saturate the output of the right leg amplifier.

Note that when using this amplifier to drive an electrode, there should be a resistor in series with the output to limit the current to be always less than 10 μA even in fault conditions. For example, if the supply used is 3.0 V, this resistor should be greater than 330 kΩ to account for component and supply variations.

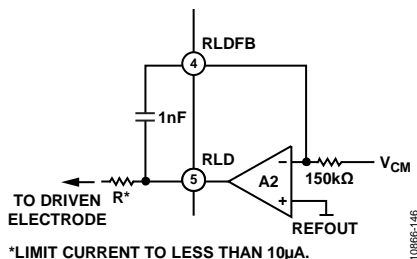

Figure 46. Typical Configuration of Right-Leg Drive Circuit

In two-electrode configurations, RLD can be used to bias the inputs through 10 MΩ resistors as described in the Leads Off Detection section. If left unused, it is recommended to configure A2 as a follower by connecting RLDFB directly to RLD.

REFERENCE BUFFER

The AD8232 operates from a single supply. To simplify the design of single-supply applications, the AD8232 includes a reference buffer to create a virtual ground between the supply voltage and the system ground. The signals present at the output of the instrumentation amplifier are referenced around this voltage. For example, if there is zero differential input voltage,

the voltage at the output of the instrumentation amplifier is this reference voltage.

The reference voltage level is set at the REFIN pin. It can be set with a voltage divider or by driving the REFIN pin from some other point in the circuit (for example, from the ADC reference). The voltage is available at the REFOUT pin for the filtering circuits or for an ADC input.

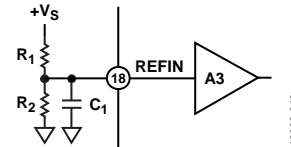

Figure 47. Setting the Internal Reference

To limit the power consumption of the voltage divider, the use of large resistors is recommended, such as 10 MΩ. The designer must keep in mind that high resistor values make it easier for interfering signals to appear at the input of the reference buffer. To minimize noise pickup, it is recommended to place the resistors close to each other and as near as possible to the REFIN terminal. Furthermore, use a capacitor in parallel with the lower resistor on the divider for additional filtering, as shown in Figure 47. Keep in mind that a large capacitor results in better noise filtering but it takes longer to settle the reference after power-up. The total time it takes the reference to settle within 1% can be estimated with the formula

$$t_{SETTLE_REFERENCE} = 5 \times \frac{R1R2C1}{R1 + R2}$$

Note that disabling the AD8232 with the shutdown terminal does not discharge this capacitor.

FAST RESTORE CIRCUIT

Because of the low cutoff frequency used in high-pass filters in ECG applications, signals may require several seconds to settle. This settling time can result in a frustrating delay for the user after a step response: for example, when the electrodes are first connected.

This fast restore function is implemented internally, as shown in Figure 48. The output of the instrumentation amplifier is connected to a window comparator. The window comparator detects a saturation condition at the output of the instrumentation amplifier when its voltage approaches 50 mV from either supply rail.

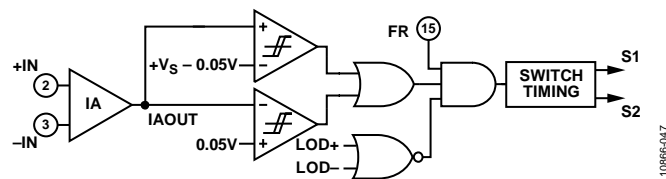

Figure 48. Fast Restore Circuit

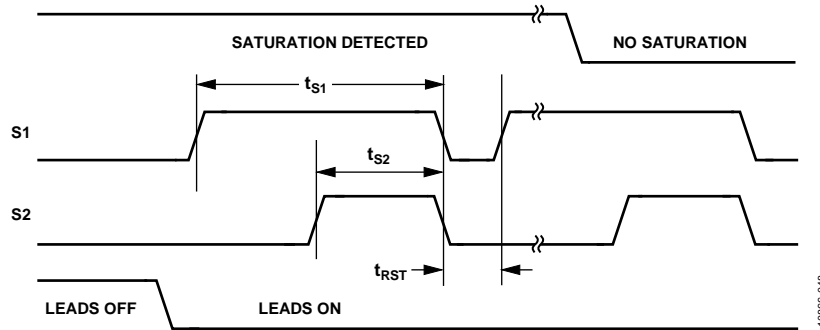

Figure 49. Timing Diagram for Fast Restore Switches
(Time Base Not to Scale)

If this saturation condition is present when both input electrodes are attached to the subject, the comparator triggers a timing circuit that automatically closes Switch S1 and Switch S2 (see Figure 49 for a timing diagram).

These two switches (S1 and S2) enable two different 10 k Ω resistor paths: one between HPSENSE and IAOUT and another between SW and REFOUT. During the time Switch S1 and Switch S2 are enabled, these internal resistors appear in parallel with their corresponding external resistors forming high-pass filters. The result is that the equivalent lower resistance shifts the pole to a higher frequency, delivering a quicker settling time. Note that the fast restore settling time depends on how quickly the internal 10 k Ω resistors of the AD8232 can drain the capacitors in the high-pass circuit. Smaller capacitor values result in a shorter settling time.

If, by the end of the timing, the saturation condition persists, the cycle repeats. Otherwise, the AD8232 returns to its normal operation. If either of the leads off comparator outputs is indicating that an electrode has been disconnected, the timing circuit is prevented from triggering because it is assumed that no valid signal is present. To disable fast restore, drive the FR pin low or tie it permanently to GND.

LEADS OFF DETECTION

The AD8232 includes leads off detection. It features ac and dc detection modes optimized for either two- or three-electrode configurations, respectively.

DC Leads Off Detection

The dc leads off detection mode is used in three-electrode configurations only. It works by sensing when either instrumentation amplifier input voltage is within 0.5 V from the positive rail. In this case, each input must have a pull-up resistor connected to the positive supply. During normal operation, the subject's potential must be inside the common-mode range of the instrumentation amplifier, which is only possible if a third electrode is connected to the output of the right leg drive amplifier.

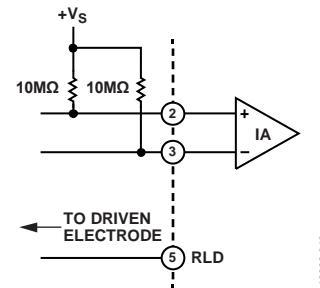

Figure 50. Circuit Configuration for DC Leads Off Detection

Because in dc leads off mode the AD8232 checks each input individually, it is possible to indicate which electrode is disconnected. The AD8232 indicates which electrode is disconnected by setting the corresponding LOD $-$ or LOD $+$ pin high. To use this mode, connect the AC/DC pin to ground.

AC Leads Off Detection

The ac leads off detection mode is useful when using two electrodes only (it does not require the use of a driven electrode). In this case, a conduction path must exist between the two electrodes, which is usually formed by two resistors, as shown in Figure 51.

These resistors also provide a path for bias return on each input. Connect each resistor to REFOUT or RLD to maintain the inputs within the common-mode range of the instrumentation amplifier.

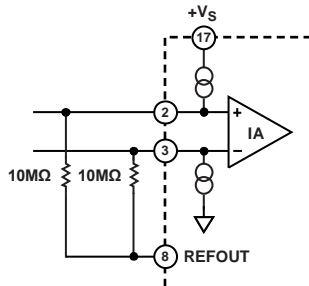

Figure 51. Circuit Configuration for AC Leads Off Detection

The AD8232 detects when an electrode is disconnected by forcing a small 100 kHz current into the input terminals. This current flows through the external resistors from IN+ to IN– and develops a differential voltage across the inputs, which is then synchronously detected and compared to an internal threshold. The recommended value for these external resistors is 10 MΩ. Low resistance values make the differential drop too low to be detected and lower the input impedance of the amplifier. When the electrodes are attached to the subject, the impedance of this path should be less than 3 MΩ to maintain the drop below the comparator's threshold.

As opposed to the dc leads off detection mode, the AD8232 is able to determine only that an electrode has lost its connection, not which one. During such an event, the LOD+ pin goes high. In this mode, the LOD– pin is not used and remains in a logic low state. To use the ac leads off mode, tie the AC/DC pin to the positive supply rail.

Note that while REFOUT is at a constant voltage value, using the RLD output as the input bias may be more effective in rejecting common-mode interference.

STANDBY OPERATION

The AD8232 includes a shutdown pin ($\overline{\text{SDN}}$) that further enhances the flexibility and ease of use in portable applications where power consumption is critical. A logic level signal can be applied to this pin to switch to shutdown mode, even when the supply is still on.

Driving the $\overline{\text{SDN}}$ pin low places the AD8232 in shutdown mode and draws less than 200 nA of supply current, offering considerable power savings. To enter normal operation, drive $\overline{\text{SDN}}$ high; when not using this feature, permanently tie $\overline{\text{SDN}}$ to +Vs.

During shutdown operation, the AD8232 is not able to maintain the REFOUT voltage, but it does not drain the REFIN voltage, thereby maintaining this additional conduction path from the supply to ground.

When emerging from a shutdown condition, the charge stored in the capacitors on the high-pass filters can saturate the instrumentation amplifier and subsequent stages. The use of the fast restore feature helps reduce the recovery time and, therefore, minimize on time in power sensitive applications.

INPUT PROTECTION

All terminals of the AD8232 are protected against ESD. In addition, the input structure allows for dc overload conditions that are a diode drop above the positive supply and a diode drop below the negative supply. Voltages beyond a diode drop of the supplies cause the ESD diodes to conduct and enable current to flow through the diode. Therefore, use an external resistor in series with each of the inputs to limit current for voltages beyond the supplies. In either scenario, the AD8232 safely handles a continuous 5 mA current at room temperature.

For applications where the AD8232 encounters extreme overload voltages, such as in cardiac defibrillators, use external series resistors and gas discharge tubes (GDT). Neon lamps are commonly used as an inexpensive alternative to GDTs. These devices can handle the application of large voltages but do not maintain the voltage below the absolute maximum ratings for the AD8232. A complete solution includes further clamping to either supply using additional resistors and low leakage diode clamps, such as BAV199 or FJH1100.

As a safety measure, place a resistor between the input pin and the electrode that is connected to the subject to ensure that the current flow never exceeds 10 μA. Calculate the value of this resistor to be equal to the supply voltage across the AD8232 divided by 10 μA.

RADIO FREQUENCY INTERFERENCE (RFI)

Radio frequency (RF) rectification is often a problem in applications where there are large RF signals. The problem appears as a dc offset voltage at the output. The AD8232 has a 15 pF gate capacitance and 10 k Ω resistors at each input. This forms a low-pass filter on each input that reduces rectification at high frequency (see Figure 52) without the addition of external elements.

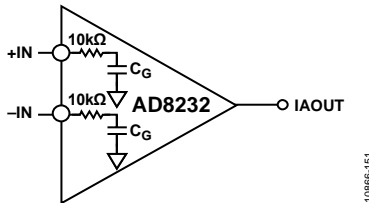

Figure 52. RFI Filter Without External Capacitors

For increased filtering, additional resistors can be added in series with each input. They must be placed as close as possible to the instrumentation amplifier inputs. These can be the same resistors used for overload and patient protection.

POWER SUPPLY REGULATION AND BYPASSING

The AD8232 is designed to be powered directly from a single 3 V battery, such as CR2032 type. It can also operate from rechargeable lithium-ion batteries, but the designer must take into account that the voltage during a charge cycle may exceed the absolute maximum ratings of the AD8232. To avoid damage to the part, use a power switch or a low power, low dropout regulator, such as ADP150.

In addition, excessive noise on the supply pins can adversely affect performance. As in all linear circuits, bypass capacitors must be used to decouple the chip power supplies. Place a 0.1 μ F capacitor close to the supply pin. A 1 μ F capacitor can be used farther away from the part. In most cases, the capacitor can be shared by other integrated circuits. Keep in mind that excessive decoupling capacitance increases power dissipation during power cycling.

INPUT REFERRED OFFSETS

Because of its internal architecture, the instrumentation amplifier should be used always with the dc blocking amplifier, shown as HPA in Figure 45.

As described in the Theory of Operation section, the dc blocking amplifier attenuates the input referred offsets present at the inputs of the instrumentation amplifier. However, this is true only when the dc blocking amplifier is used as an integrator. In this configuration, the input offsets from the dc blocking amplifier dominate appear directly at the output of the instrumentation amplifier.

If the dc blocking amplifier is used as a follower instead of its intended function as an integrator, the input referred offsets of the in-amp are amplified by a factor of 100.

LAYOUT RECOMMENDATIONS

It is important to follow good layout practices to optimize system performance. In low power applications, most resistors are of a high value to minimize additional supply current. The challenge of using high value resistors is that high impedance nodes become even more susceptible to noise pickup and board parasitics, such as capacitance and surface leakages. Keep all of the connections between high impedance nodes as short as possible to avoid introducing additional noise and errors from corrupting the signal.

To maintain high CMRR over frequency, keep the input traces symmetrical and length matched. Place safety and input bias resistors in the same position relative to each input. In addition, the use of a ground plane significantly improves the noise rejection of the system.

APPLICATIONS INFORMATION

ELIMINATING ELECTRODE OFFSETS

The instrumentation amplifier in the AD8232 is designed to apply gain and to filter out near dc signals simultaneously. This capability allows it to amplify a small ECG signal by a factor of 100 yet reject electrode offsets as large as ± 300 mV.

To achieve offset rejection, connect an RC network between the output of the instrumentation amplifier, HPSENSE, and HPDRIVE, as shown in Figure 53.

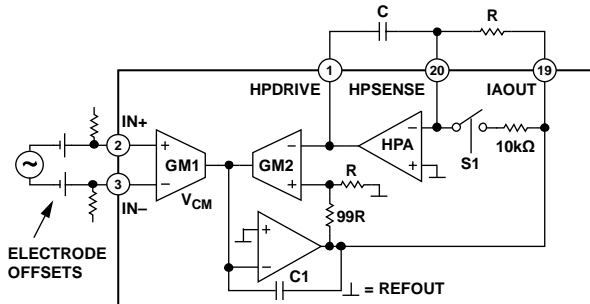

Figure 53. Eliminating Electrode Offsets

This RC network forms an integrator that feeds any near dc signals back into the instrumentation amplifier, thus eliminating the offsets without saturating any node and maintaining high signal gain.

In addition to blocking offsets present across the inputs of the instrumentation amplifier, this integrator also works as a high-pass filter that minimizes the effect of slow moving signals, such as baseline wander. The cutoff frequency of the filter is given by the equation

$$f_{-3dB} = \frac{100}{2\pi RC}$$

where R is in ohms and C is in farads.

Note that the filter cutoff is 100 times higher than is typically expected from a single-pole filter. Because of the feedback architecture of the instrumentation amplifier, the typical filter cutoff equation is modified by the gain of 100 of the instrumentation amplifier.

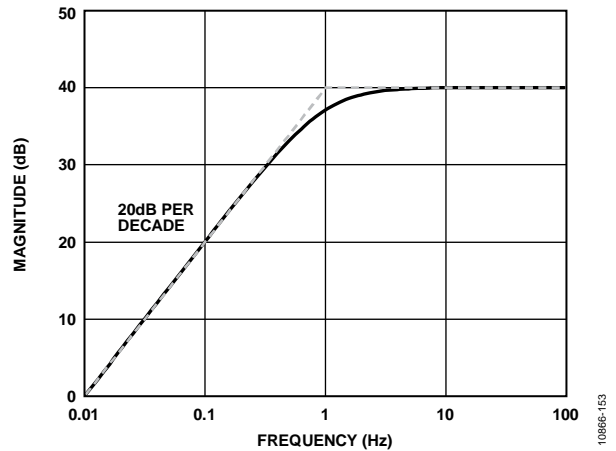

Figure 54. Frequency Response of Single-Pole DC Blocking Circuit

Just like with any high-pass filter with low frequency cutoff, any fast change in dc offset takes a long time to settle. If such change saturates the instrumentation amplifier output, the S1 switch briefly enables the 10 kΩ resistor path, thus moving the cutoff frequency to

$$f_{-3dB} = \frac{100(R + 10^4)}{2\pi RC(10^4)} \quad (1)$$

For values of R greater than 100 kΩ, the expression in Equation 1 can be approximated by

$$f_{-3dB} = \frac{1}{200\pi C}$$

This higher cutoff reduces the settling time and enables faster recovery of the ECG signal. For more information, see the Fast Restore Circuit section.

HIGH-PASS FILTERING

The AD8232 can implement higher order high-pass filters. A higher filter order yields better artifact rejection but at a cost of increased signal distortion and more passive components on the printed circuit board (PCB).

Two-Pole High-Pass Filter

A two-pole architecture can be implemented by adding a simple ac coupling RC at the output of the instrumentation amplifier, as shown in Figure 55.

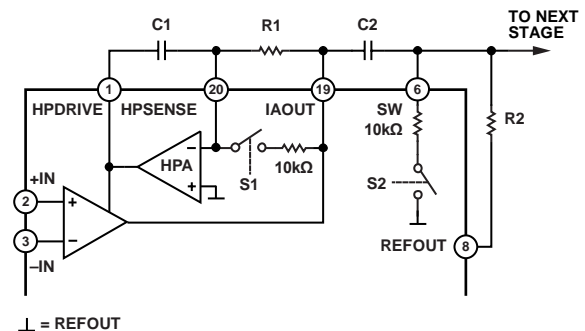

Figure 55. Schematic for a Two-Pole High-Pass Filter

Note that the right side of C2 connects to the SW terminal. Just like S1, S2 reduces the recovery time for this ac coupling network by placing 10 kΩ in parallel with R2. See the Fast Restore Circuit section for additional details on switch timing and trigger conditions.

Keep in mind that if this passive network is not buffered, it exhibits higher output impedance at the input of a subsequent low-pass filter, such as with Sallen-Key filter topologies. Careful component selection can yield good results without a buffer. See the Low-Pass Filtering and Gain section for additional information on component selection.

Additional High-Pass Filtering Options

In addition to the topologies explained in the previous sections, an additional pole may be added to the dc blocking circuit for additional rejection of low frequency signals. This configuration is shown in Figure 56.

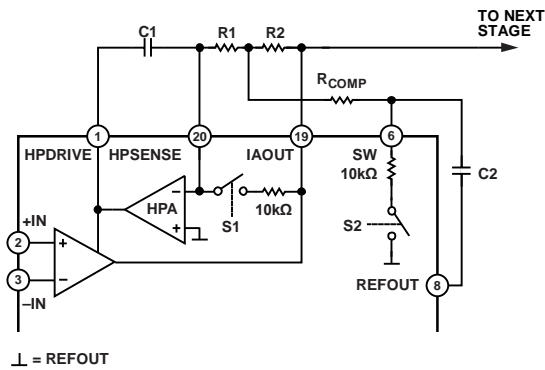

Figure 56. Schematic for an Alternative Two-Pole High-Pass Filter

An extra benefit of this circuit topology is that it allows lower cutoff frequency with lower R and C values and the resistor, R_{COMP}, can be used to control the Q of the filter to achieve narrow band-pass filters (for heart rate detection) or maximum pass-band flatness (for cardiac monitoring).

With this topology, the filter attenuation reverts to a single pole roll off at very low frequencies. Because the initial roll off was 40 dB per decade, this reversion to 20 dB per decade has little impact on the ability of the filter to reject out-of-band low frequency signals.

The designer may choose different values to achieve the desired filter performance. To simplify the design process, use the following recommendations as a starting point for component value selection.

$$R1 = R2 \geq 100 \text{ k}\Omega$$

$$C1 = C2$$

$$R_{COMP} = 0.14 \times R1$$

The cutoff frequency is located at

$$f_c = \frac{10}{2\pi \sqrt{R1 C1 R2 C2}}$$

The selection of R_{COMP} to be 0.14 times the value of the other two resistors optimizes the filter for a maximally flat pass band. Reduce its value to increase the Q and, consequently, the peaking of the filter. Keep in mind that a very low value of R_{COMP} can result in an unstable circuit. The selection of values based on these criteria result in a transfer function similar to the one shown in Figure 58. When additional low frequency rejection is desired, a high-order high-pass filter can be implemented by adding an ac coupling network at the output of the instrumentation amplifier, as shown in Figure 57. The SW terminal is connected to the ac coupling network to obtain the best settling time response when fast restore engages.

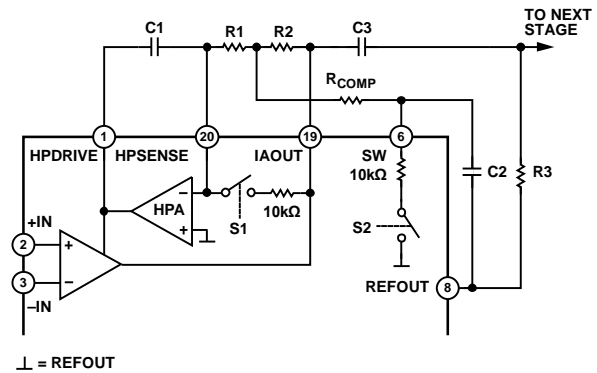

Figure 57. Schematic for a Three-Pole High-Pass Filter

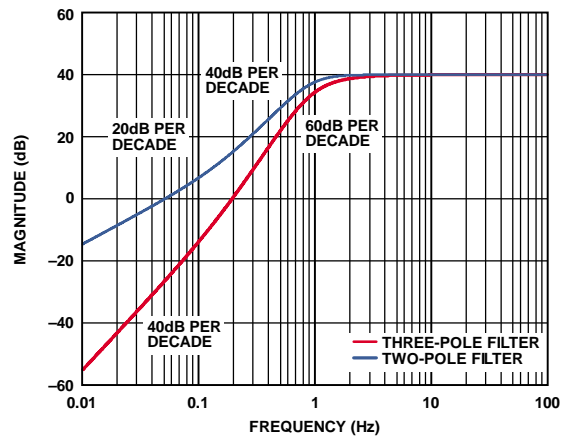

Figure 58. Frequency Response of Circuits in Figure 56 and Figure 57

Careful analysis and adjustment of all of the component values in practice is recommended to optimize the filter characteristics. A useful hint is to reduce the value of R_{COMP} to increase the peaking of the active filter to overcome the additional roll off introduced by the ac coupling network. Proper adjustment can yield the best pass-band flatness.

The design of the high-pass filter involves tradeoffs between signal distortion, component count, low frequency rejection, and component sizes. For example, a single-pole high-pass filter results in the least distortion to the signal, but its rejection of low-frequency artifacts is the lowest

Table 4 compares the recommended filtering options.

Table 4. Comparison of High-Pass Filtering Options

	Filter Order	Component Count	Low Frequency Rejection	Capacitor Sizes/Values	Signal Distortion¹	Output Impedance²
Figure 53	1	2	Good	Large	Low	Low
Figure 55	2	4	Better	Large	Medium	Higher
Figure 56	2	5	Better	Smaller	Medium	Low
Figure 57	3	7	Best	Smaller	Highest	Higher

¹For equivalent corner frequency location.

²Output impedance refers to the drive capability of the high-pass filter before the low-pass filter. Low output impedance is desirable to allow flexibility in the selection of values for a low-pass filter, as explained in the Low-Pass Filtering and Gain section.

LOW-PASS FILTERING AND GAIN

The AD8232 includes an uncommitted op amp that can be used for extra gain and filtering. For applications that do not require a high-order filter, a simple RC low-pass filter should suffice, and the op amp can buffer or further amplify the signal.

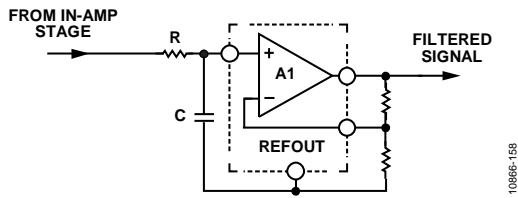

Figure 59. Schematic for a Single-Pole Low-Pass Filter and Additional Gain

Applications that require a steeper roll off or a sharper cut off, a Sallen-Key filter topology can be implemented, as shown in Figure 60.

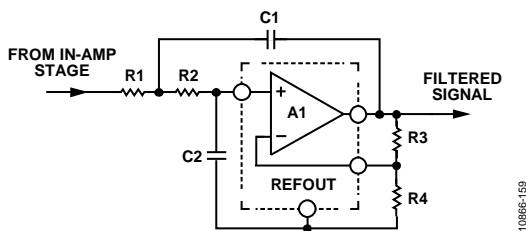

Figure 60. Schematic for a Two-Pole Low-Pass Filter

The following equations describe the low-pass cut off frequency, gain, and Q:

$$f_c = 1/(2\pi\sqrt{R1 C1 R2 C2})$$

$$\text{Gain} = 1 + R3/R4$$

$$Q = \frac{\sqrt{R1 \times C1 \times R2 \times C2}}{R1 \times C2 + R2 \times C2 + R1 \times C1(1 - \text{Gain})}$$

Note that changing the gain has an effect on Q and vice versa. Common values for Q are 0.5 to avoid peaking or 0.7 for maximum flatness and sharp cut off. A high value of Q can be used in narrow-band applications to increase peaking and the selectivity of the band-pass filter.

A common design procedure is to set $R1 = R2 = R$ and $C1 = C2 = C$, which simplifies the expressions for cutoff frequency and Q to

$$f_c = 1/(2\pi RC)$$

$$Q = \frac{1}{3 - \text{Gain}}$$

Note that Q can be controlled by setting the gain with R3 and R4; however, this limits the gain to be less than 3. For gain values equal to or greater than 3, the circuit becomes unstable. A simple modification that allows higher gains is to make the value of C2 at least four times larger than C1.

It is important to note that these design equations only hold true in the case that the output impedance of the previous stage is much lower than the input impedance of the Sallen-Key filter. This is not the case when using an ac coupling network

between the instrumentation amplifier output and the input of the low-pass filter without a buffer.

To connect these two filtering stages properly without a buffer, make the value of R1 at least ten times larger than the resistor of the ac coupling network (labeled as R2 in Figure 55).

DRIVING ANALOG-TO-DIGITAL CONVERTERS

The ability of AD8232 to drive capacitive loads makes it ideal to drive an ADC without the need for an additional buffer. However, depending on the input architecture of the ADC, a simple low-pass RC network may be required to decouple the transients from the switched-capacitor input typical of modern ADCs. This RC network also acts as an additional filter that can help reduce noise and aliasing. Follow the recommended guidelines from the ADC data sheet for the selection of proper R and C values.

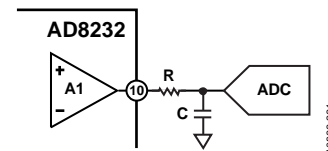

Figure 61. Driving an ADC

DRIVEN ELECTRODE

A driven lead (or reference electrode) is often used to minimize the effects of common-mode voltages induced by the power line and other interfering sources. The AD8232 extracts the common-mode voltage from the instrumentation amplifier inputs and makes it available through the RLD amplifier to drive an opposing signal into the patient. This functionality maintains the voltage between the patient and the AD8232 at a near constant, greatly improving the common-mode rejection ratio.

As a safety measure, place a resistor between the RLD pin and the electrode connected to the subject to ensure that current flow never exceeds 10 μA . Calculate the value of this resistor to be equal to the supply voltage across the AD8232 divided by 10 μA .

The AD8232 implements an integrator formed by an internal 150 k Ω resistor and an external capacitor to drive this electrode. Choice of the integrator capacitor is a tradeoff between line rejection capability and stability. The capacitor should be small to maintain as much loop gain as possible, around 50 Hz and 60 Hz, which are typical line frequencies. For stability, the gain of the integrator should be less than unity at the frequency of any other poles in the loop, such as those formed by the patient's capacitance and the safety resistors. The suggested application circuits use a 1 nF capacitor, which results in a loop gain of about 20 at line frequencies, with a crossover frequency of about 1 kHz.

In a two-lead configuration, the RLD amplifier can be used to drive the bias current resistors on the inputs. Although not as effective as a true driven electrode, this configuration can provide some common-mode rejection improvement if the sense electrode impedance is small and well matched.

PACKAGING AND ORDERING INFORMATION

OUTLINE DIMENSIONS

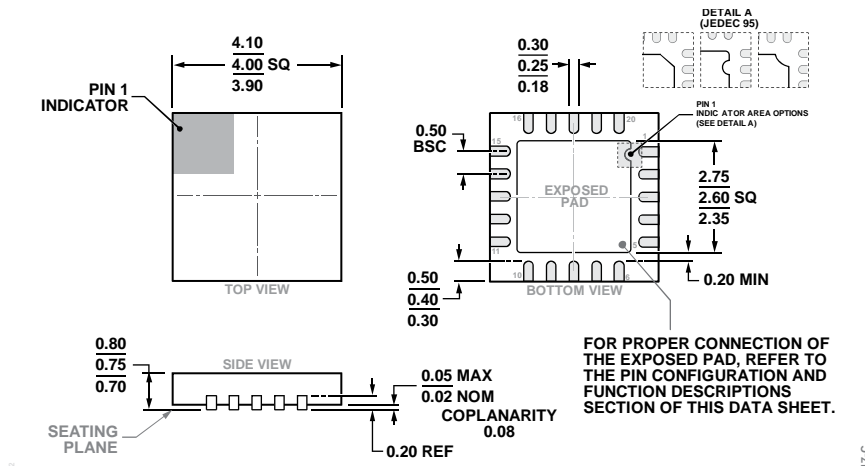

COMPLIANT TO JEDEC STANDARDS MO-220-WGGD-11.

Figure 69. 20-Lead Lead Frame Chip Scale Package [LFCSP]
4 mm × 4 mm Body and 0.75 mm Package Height
(CP-20-8)

Dimensions shown in millimeters

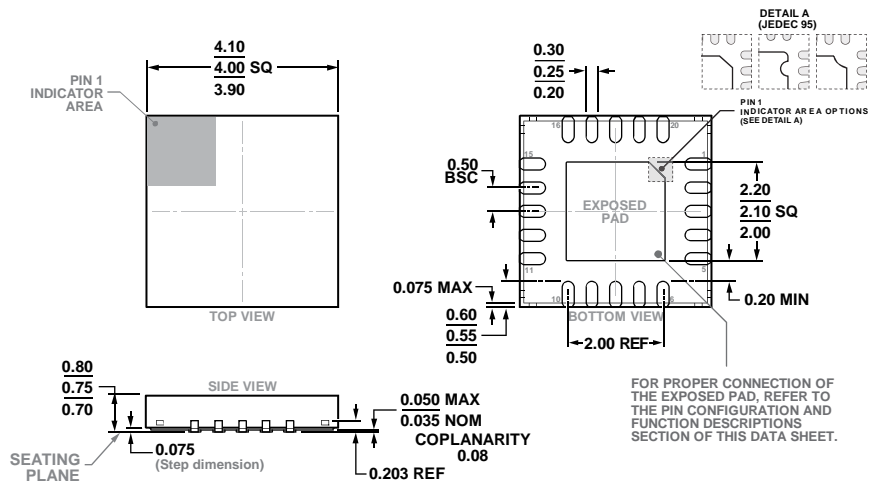

COMPLIANT TO JEDEC STANDARDS MO-220-WGGD-1

Figure 70. 20-Lead Lead Frame Chip Scale Package [LFCSP_SS]
4 mm × 4 mm Body, With Side Solderable Leads
(CS-20-1)

Dimensions shown in millimeters

ORDERING GUIDE

Model ¹	Temperature Range	Package Description	Package Option
AD8232ACPZ-R7	–40°C to +85°C	20-Lead Lead Frame Chip Scale Package [LFCSP]	CP-20-8
AD8232ACPZ-RL	–40°C to +85°C	20-Lead Lead Frame Chip Scale Package [LFCSP]	CP-20-8
AD8232ACPZ-WP	–40°C to +85°C	20-Lead Lead Frame Chip Scale Package [LFCSP]	CP-20-8
AD8232WACSZ	–40°C to +105°C	20-Lead Lead Frame Chip Scale Package [LFCSP_SS]	CS-20-1
AD8232WACSZ-RL	–40°C to +105°C	20-Lead Lead Frame Chip Scale Package [LFCSP_SS]	CS-20-1
AD8232WACSZ-R7	–40°C to +105°C	20-Lead Lead Frame Chip Scale Package [LFCSP_SS]	CS-20-1
AD8232-EVALZ		Evaluation Board	

¹ Z = RoHS Compliant Part.

NOTES