

Important notice

Dear Customer,

On 7 February 2017 the former NXP Standard Product business became a new company with the tradename **Nexperia**. Nexperia is an industry leading supplier of Discrete, Logic and PowerMOS semiconductors with its focus on the automotive, industrial, computing, consumer and wearable application markets

In data sheets and application notes which still contain NXP or Philips Semiconductors references, use the references to Nexperia, as shown below.

Instead of <http://www.nxp.com>, <http://www.philips.com/> or <http://www.semiconductors.philips.com/>, use <http://www.nexperia.com>

Instead of sales.addresses@www.nxp.com or sales.addresses@www.semiconductors.philips.com, use salesaddresses@nexperia.com (email)

Replace the copyright notice at the bottom of each page or elsewhere in the document, depending on the version, as shown below:

- © NXP N.V. (year). All rights reserved or © Koninklijke Philips Electronics N.V. (year). All rights reserved

Should be replaced with:

- © **Nexperia B.V. (year). All rights reserved.**

If you have any questions related to the data sheet, please contact our nearest sales office via e-mail or telephone (details via salesaddresses@nexperia.com). Thank you for your cooperation and understanding,

Kind regards,

Team Nexperia

DATA SHEET

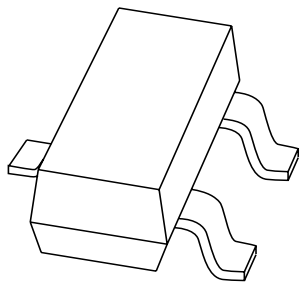

BC856; BC857; BC858 PNP general purpose transistors

Product data sheet
Supersedes data of 2003 Apr 09

2004 Jan 16

PNP general purpose transistors

BC856; BC857; BC858

FEATURES

- Low current (max. 100 mA)
- Low voltage (max. 65 V).

APPLICATIONS

- General purpose switching and amplification.

DESCRIPTION

PNP transistor in a SOT23 plastic package.
 NPN complements: BC846, BC847 and BC848.

MARKING

TYPE NUMBER	MARKING CODE ⁽¹⁾
BC856	3D*
BC856A	3A*
BC856B	3B*
BC857	3H*
BC857A	3E*
BC857B	3F*
BC857C	3G*
BC858B	3K*

Note

- * = p: made in Hong Kong.
 * = t: made in Malaysia.
 * = W: made in China.

PINNING

PIN	DESCRIPTION
1	base
2	emitter
3	collector

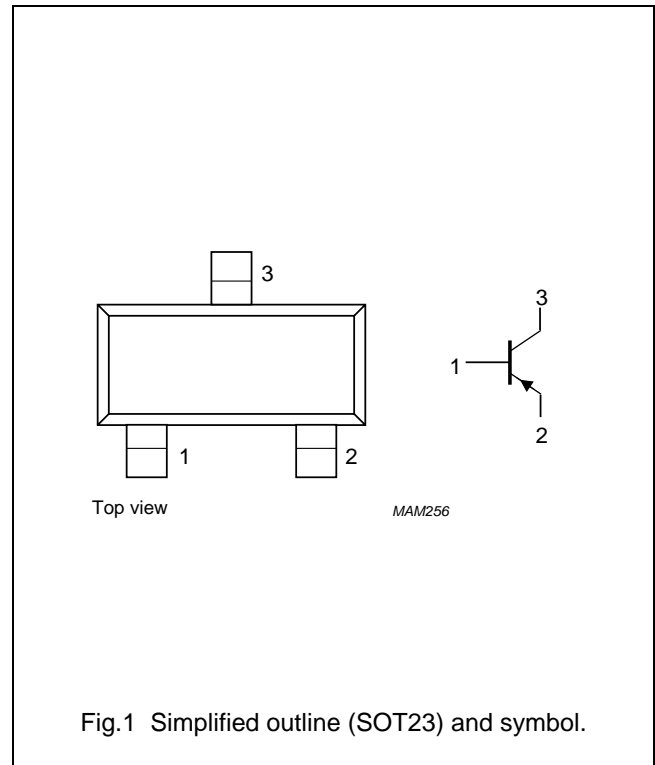

ORDERING INFORMATION

TYPE NUMBER	PACKAGE		
	NAME	DESCRIPTION	VERSION
BC856	–	plastic surface mounted package; 3 leads	SOT23
BC857	–	plastic surface mounted package; 3 leads	SOT23
BC858	–	plastic surface mounted package; 3 leads	SOT23

PNP general purpose transistors

BC856; BC857; BC858

LIMITING VALUES

In accordance with the Absolute Maximum System (IEC 60134).

SYMBOL	PARAMETER	CONDITIONS	MIN.	MAX.	UNIT
V _{CBO}	collector-base voltage	open emitter			
	BC856		–	–80	V
	BC857		–	–50	V
	BC858		–	–30	V
V _{CEO}	collector-emitter voltage	open base			
	BC856		–	–65	V
	BC857		–	–45	V
	BC858		–	–30	V
V _{EBO}	emitter-base voltage	open collector	–	–5	V
I _C	collector current (DC)		–	–100	mA
I _{CM}	peak collector current		–	–200	mA
I _{BM}	peak base current		–	–200	mA
P _{tot}	total power dissipation	T _{amb} ≤ 25 °C; note 1	–	250	mW
T _{stg}	storage temperature		–65	+150	°C
T _j	junction temperature		–	150	°C
T _{amb}	operating ambient temperature		–65	+150	°C

Note

1. Transistor mounted on an FR4 printed-circuit board, standard footprint.

THERMAL CHARACTERISTICS

SYMBOL	PARAMETER	CONDITIONS	TYPICAL	UNIT
R _{th(j-a)}	thermal resistance from junction to ambient	in free air; note 1	500	K/W

Note

1. Transistor mounted on an FR4 printed-circuit board, standard footprint.

PNP general purpose transistors

BC856; BC857; BC858

CHARACTERISTICS

$T_{amb} = 25\text{ °C}$ unless otherwise specified.

SYMBOL	PARAMETER	CONDITIONS	MIN.	TYP.	MAX.	UNIT				
I_{CBO}	collector-base cut-off current	$V_{CB} = -30\text{ V}; I_E = 0$	–	–1	–15	nA				
		$V_{CB} = -30\text{ V}; I_E = 0;$ $T_j = 150\text{ °C}$	–	–	–4	μA				
I_{EBO}	emitter-base cut-off current	$V_{EB} = -5\text{ V}; I_C = 0$	–	–	–100	nA				
h_{FE}	DC current gain	$I_C = -2\text{ mA}; V_{CE} = -5\text{ V}$								
							BC856	125	–	475
							BC857	125	–	800
							BC856A; BC857A	125	–	250
							BC856B; BC857B; BC858B	220	–	475
BC857C	420	–	800							
V_{CEsat}	collector-emitter saturation voltage	$I_C = -10\text{ mA}; I_B = -0.5\text{ mA}$	–	–75	–300	mV				
		$I_C = -100\text{ mA}; I_B = -5\text{ mA};$ note 1	–	–250	–650	mV				
V_{BEsat}	base-emitter saturation voltage	$I_C = -10\text{ mA}; I_B = -0.5\text{ mA}$	–	–700	–	mV				
		$I_C = -100\text{ mA}; I_B = -5\text{ mA};$ note 1	–	–850	–	mV				
V_{BE}	base-emitter voltage	$I_C = -2\text{ mA}; V_{CE} = -5\text{ V}$	–600	–650	–750	mV				
		$I_C = -10\text{ mA}; V_{CE} = -5\text{ V}$	–	–	–820	mV				
C_c	collector capacitance	$V_{CB} = -10\text{ V}; I_E = I_e = 0;$ $f = 1\text{ MHz}$	–	4.5	–	pF				
f_T	transition frequency	$V_{CE} = -5\text{ V}; I_C = -10\text{ mA};$ $f = 100\text{ MHz}$	100	–	–	MHz				
F	noise figure	$I_C = -200\text{ }\mu\text{A}; V_{CE} = -5\text{ V};$ $R_S = 2\text{ k}\Omega; f = 1\text{ kHz};$ $B = 200\text{ Hz}$	–	2	10	dB				

Note

1. Pulse test: $t_p \leq 300\text{ }\mu\text{s}; \delta \leq 0.02$.

PNP general purpose transistors

BC856; BC857; BC858

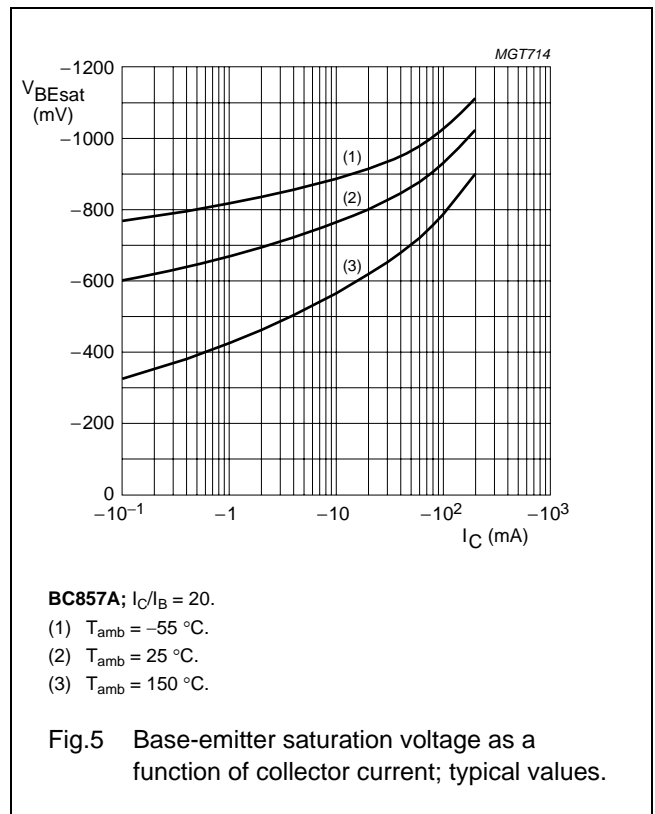
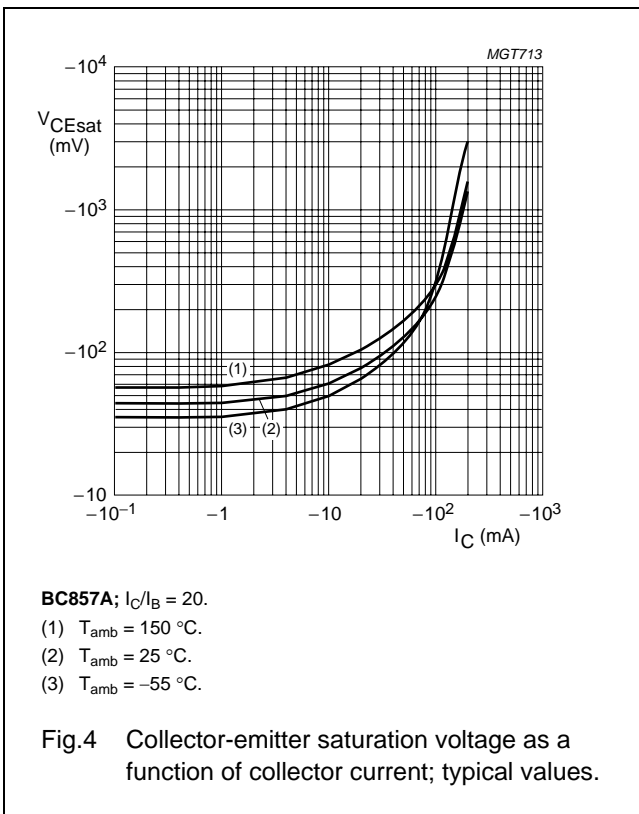
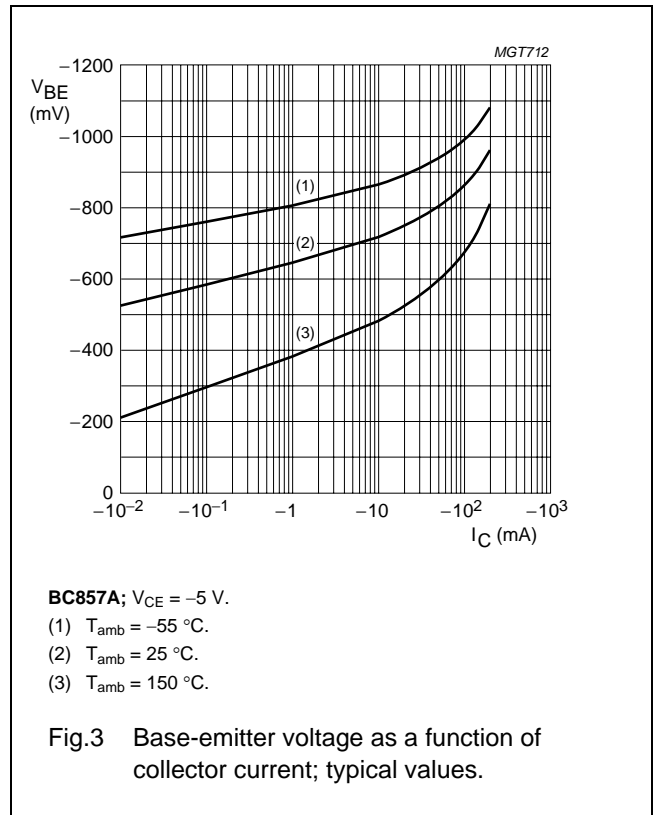
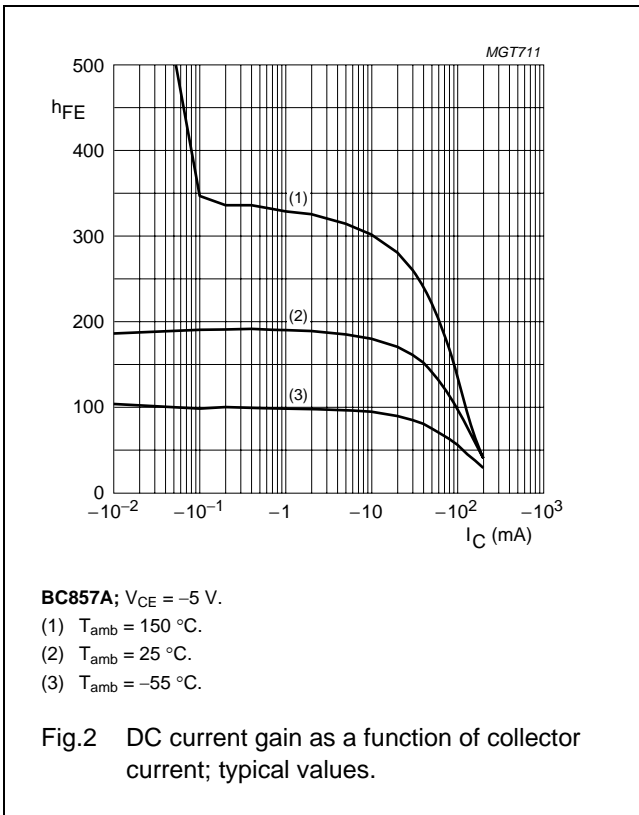

PNP general purpose transistors

BC856; BC857; BC858

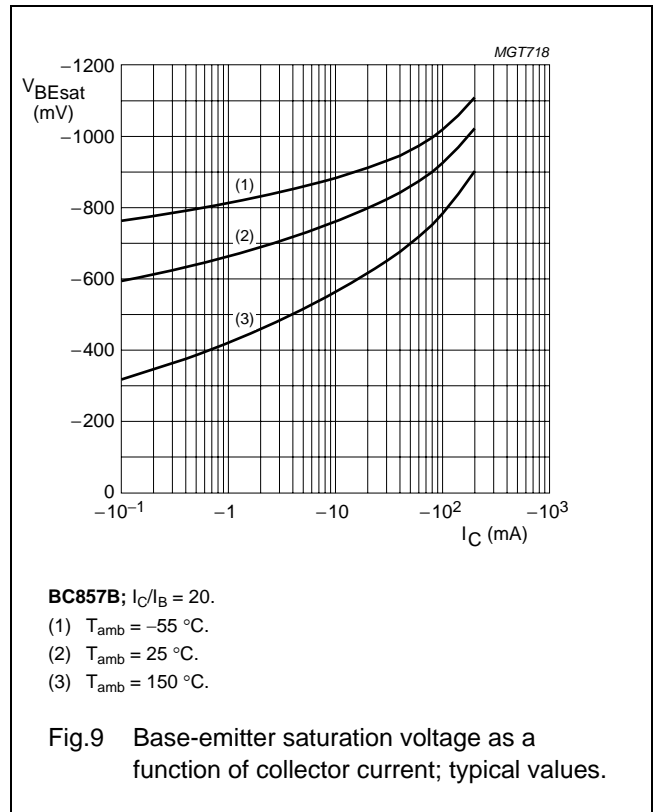
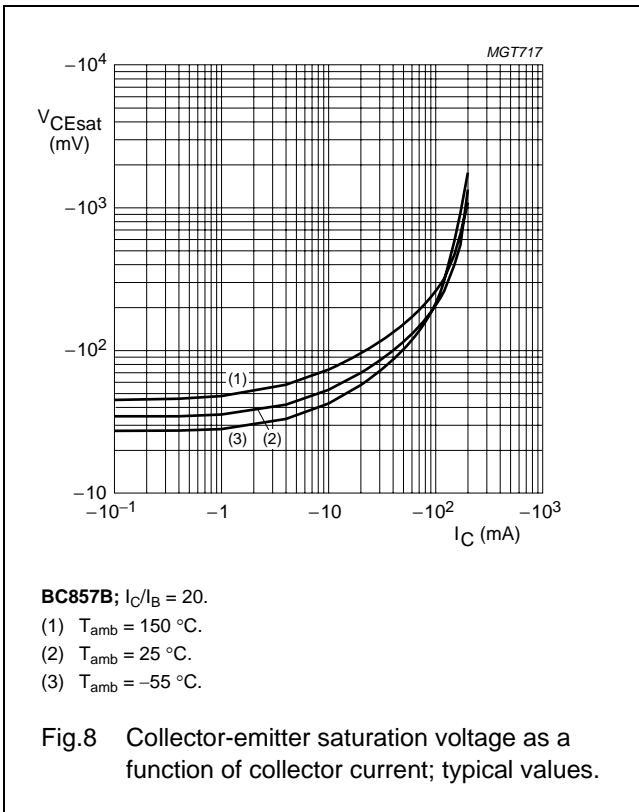
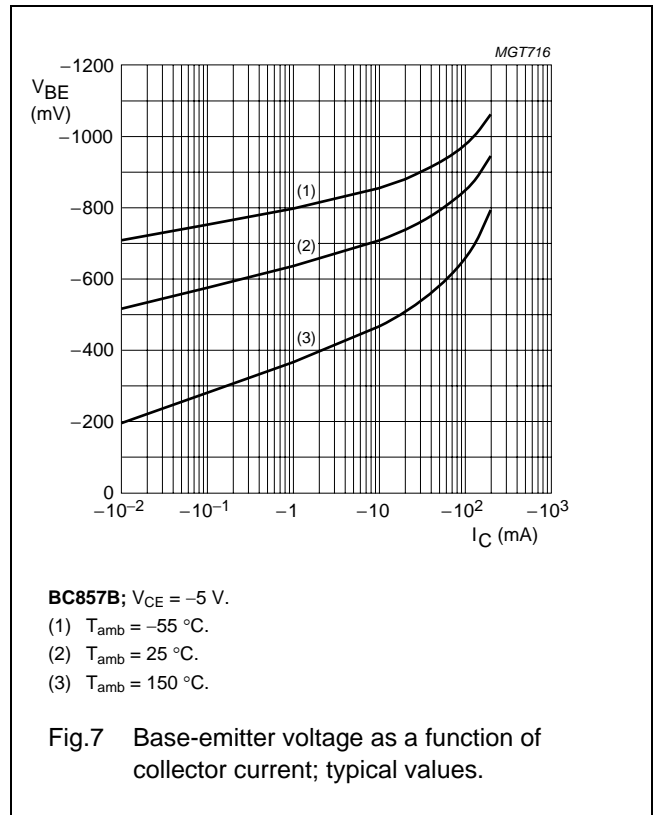
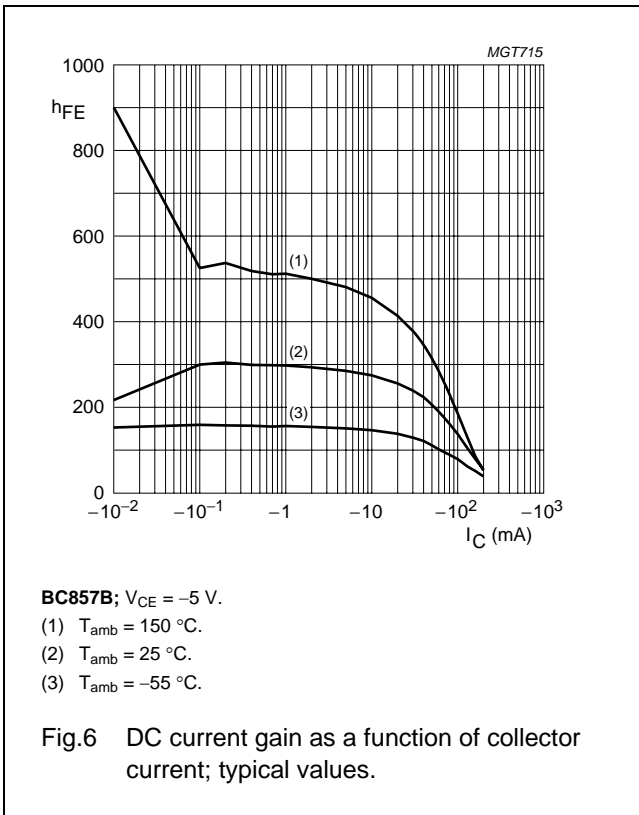

PNP general purpose transistors

BC856; BC857; BC858

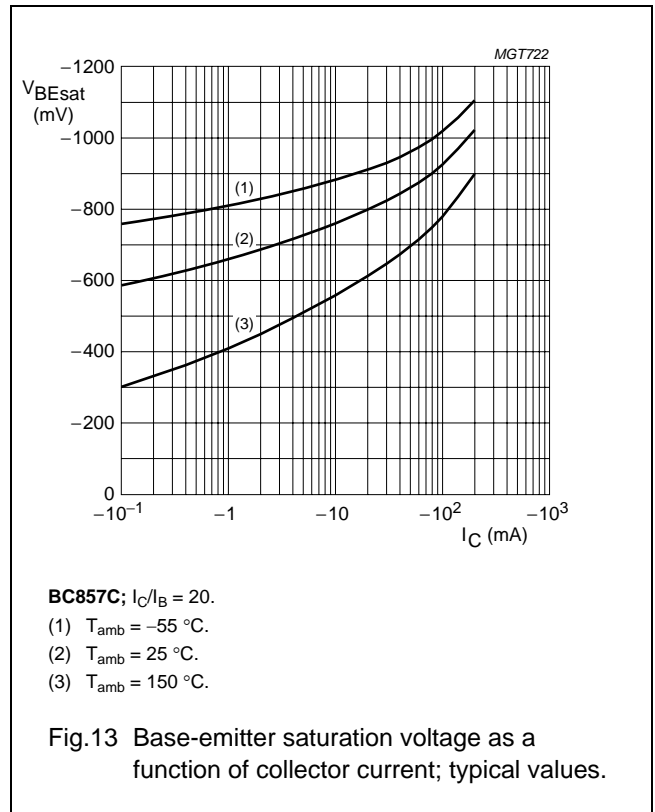
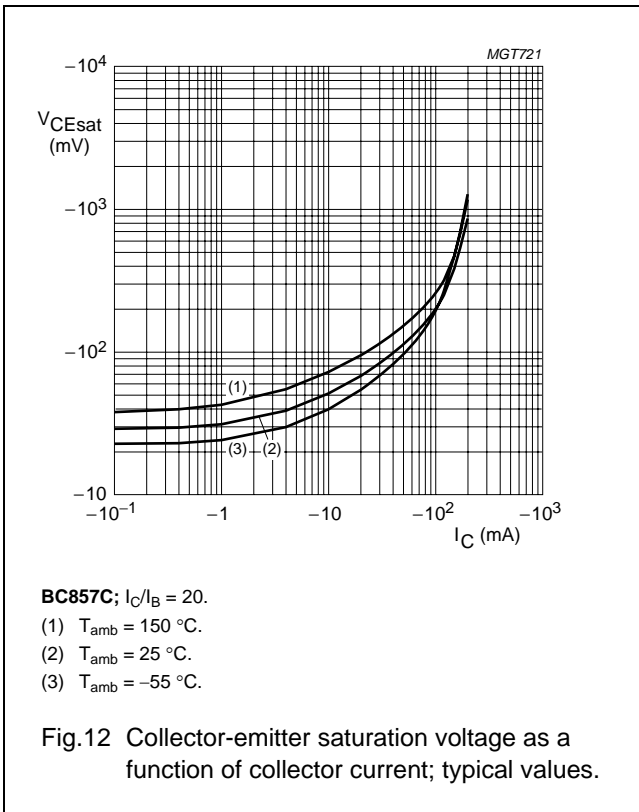
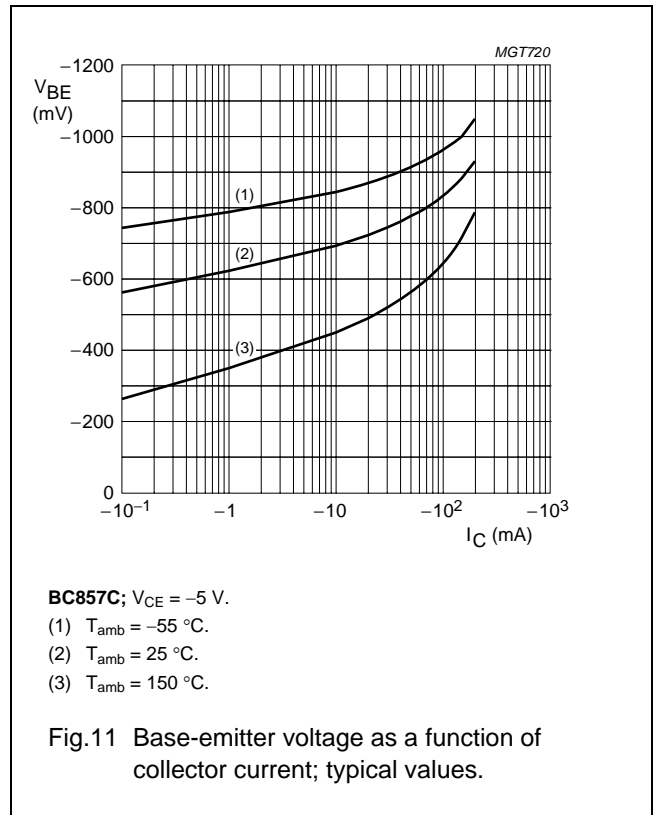
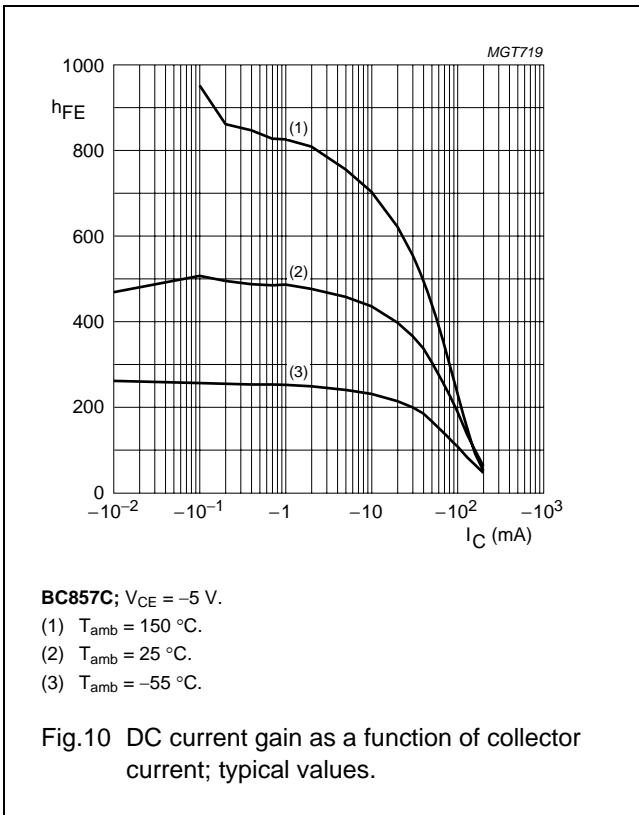

PNP general purpose transistors

BC856; BC857; BC858

PACKAGE OUTLINE

Plastic surface-mounted package; 3 leads

SOT23

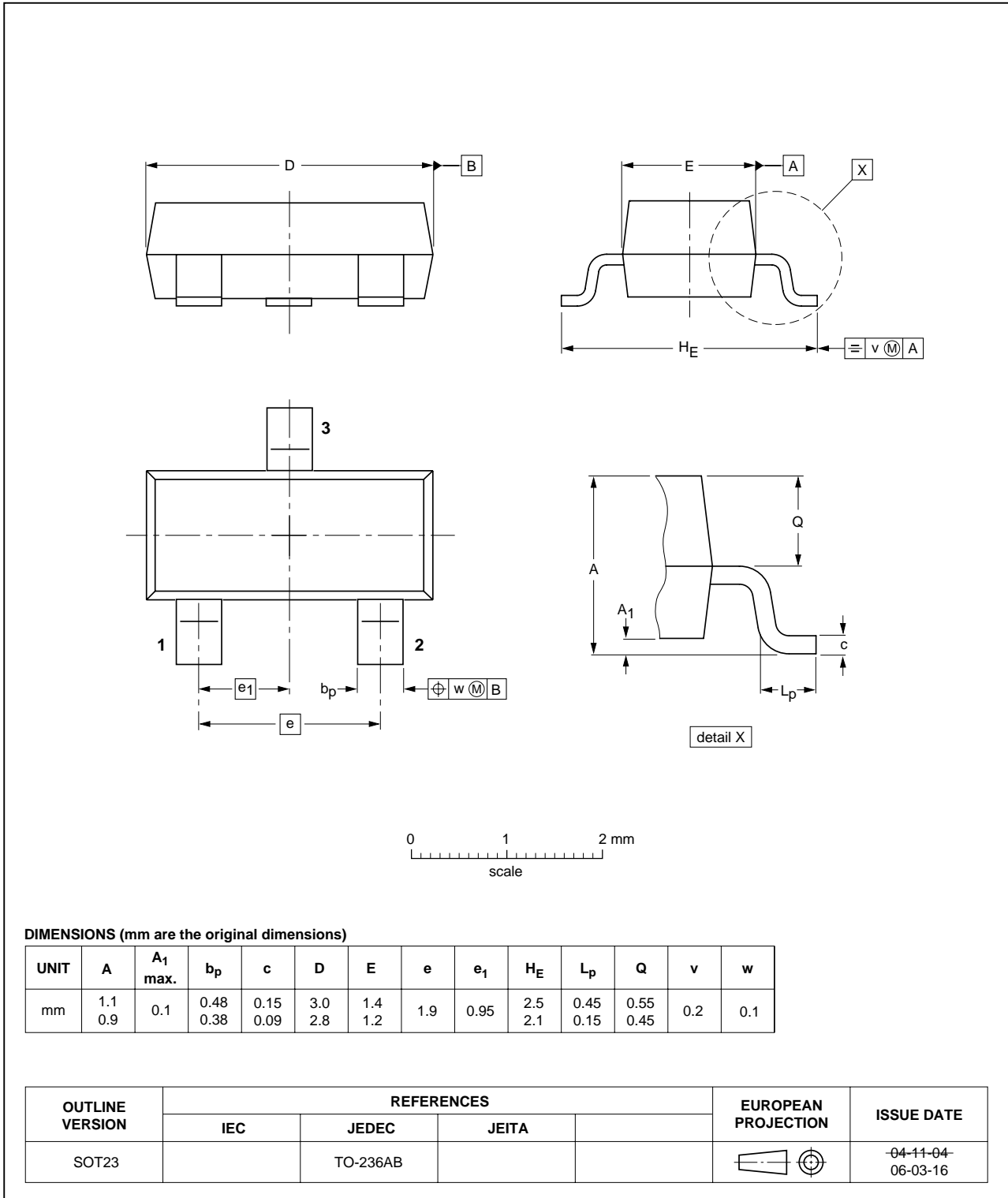

PNP general purpose transistors

BC856; BC857; BC858

DATA SHEET STATUS

DOCUMENT STATUS ⁽¹⁾	PRODUCT STATUS ⁽²⁾	DEFINITION
Objective data sheet	Development	This document contains data from the objective specification for product development.
Preliminary data sheet	Qualification	This document contains data from the preliminary specification.
Product data sheet	Production	This document contains the product specification.

Notes

1. Please consult the most recently issued document before initiating or completing a design.
2. The product status of device(s) described in this document may have changed since this document was published and may differ in case of multiple devices. The latest product status information is available on the Internet at URL <http://www.nxp.com>.

DISCLAIMERS

General — Information in this document is believed to be accurate and reliable. However, NXP Semiconductors does not give any representations or warranties, expressed or implied, as to the accuracy or completeness of such information and shall have no liability for the consequences of use of such information.

Right to make changes — NXP Semiconductors reserves the right to make changes to information published in this document, including without limitation specifications and product descriptions, at any time and without notice. This document supersedes and replaces all information supplied prior to the publication hereof.

Suitability for use — NXP Semiconductors products are not designed, authorized or warranted to be suitable for use in medical, military, aircraft, space or life support equipment, nor in applications where failure or malfunction of an NXP Semiconductors product can reasonably be expected to result in personal injury, death or severe property or environmental damage. NXP Semiconductors accepts no liability for inclusion and/or use of NXP Semiconductors products in such equipment or applications and therefore such inclusion and/or use is at the customer's own risk.

Applications — Applications that are described herein for any of these products are for illustrative purposes only. NXP Semiconductors makes no representation or warranty that such applications will be suitable for the specified use without further testing or modification.

Limiting values — Stress above one or more limiting values (as defined in the Absolute Maximum Ratings System of IEC 60134) may cause permanent damage to

the device. Limiting values are stress ratings only and operation of the device at these or any other conditions above those given in the Characteristics sections of this document is not implied. Exposure to limiting values for extended periods may affect device reliability.

Terms and conditions of sale — NXP Semiconductors products are sold subject to the general terms and conditions of commercial sale, as published at <http://www.nxp.com/profile/terms>, including those pertaining to warranty, intellectual property rights infringement and limitation of liability, unless explicitly otherwise agreed to in writing by NXP Semiconductors. In case of any inconsistency or conflict between information in this document and such terms and conditions, the latter will prevail.

No offer to sell or license — Nothing in this document may be interpreted or construed as an offer to sell products that is open for acceptance or the grant, conveyance or implication of any license under any copyrights, patents or other industrial or intellectual property rights.

Export control — This document as well as the item(s) described herein may be subject to export control regulations. Export might require a prior authorization from national authorities.

Quick reference data — The Quick reference data is an extract of the product data given in the Limiting values and Characteristics sections of this document, and as such is not complete, exhaustive or legally binding.

NXP Semiconductors

Customer notification

This data sheet was changed to reflect the new company name NXP Semiconductors, including new legal definitions and disclaimers. No changes were made to the technical content, except for package outline drawings which were updated to the latest version.

Contact information

For additional information please visit: <http://www.nxp.com>

For sales offices addresses send e-mail to: salesaddresses@nxp.com

© NXP B.V. 2009

All rights are reserved. Reproduction in whole or in part is prohibited without the prior written consent of the copyright owner.

The information presented in this document does not form part of any quotation or contract, is believed to be accurate and reliable and may be changed without notice. No liability will be accepted by the publisher for any consequence of its use. Publication thereof does not convey nor imply any license under patent- or other industrial or intellectual property rights.

Printed in The Netherlands

R75/06/pp10

Date of release: 2004 Jan 16

Document order number: 9397 750 12397



Mouser Electronics

Authorized Distributor

Click to View Pricing, Inventory, Delivery & Lifecycle Information:

Nexperia:

[BC856B /T3](#) [BC857 T/R](#) [BC857A T/R](#) [BC857B /T3](#) [BC857C /T3](#) [BC858B /T3](#) [BC858B T/R](#) [BC856A,215](#)
[BC856B,235](#) [BC856B,215](#) [BC856,215](#) [BC857,235](#) [BC857A,215](#) [BC857B,235](#) [BC857B,215](#) [BC857C,235](#)
[BC857C,215](#) [BC857,215](#) [BC858B,235](#) [BC858B,215](#) [BC856BMYL](#) [BC856BMBYL](#)