

SCHOTTKY BARRIER RECTIFIER

VOLTAGE RANGE 20 to 200 Volts CURRENT 3.0 Amperes

FEATURES

- * High reliability
- * Low switching loss
- * Low forward voltage drop
- * High current capability
- * High switching capability

MECHANICAL DATA

- * Epoxy: Device has UL flammability classification 94V-O
- * Case: Molded plastic
- * Lead: MIL-STD-202E method 208C guaranteed
- * Mounting: position: Any
- * Weight: 1.18 grams

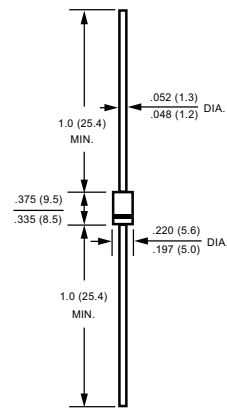

MAXIMUM RATINGS AND ELECTRICAL CHARACTERISTICS

Ratings at 25 °C ambient temperature unless otherwise specified.
resistive or inductive load.

MAXIMUM RATINGS (@ TA=25 °C unless otherwise noted)

RATINGS	SYMBOL	SR320	SR330	SR340	SR350	SR360	SR380	SR3100	SR3150	SR3200	UNITS	
Maximum Recurrent Peak Reverse Voltage	V _{RRM}	20	30	40	50	60	80	100	150	200	Volts	
Maximum RMS Voltage	V _{RMS}	14	21	28	35	42	56	70	105	140	Volts	
Maximum DC Blocking Voltage	V _{DC}	20	30	40	50	60	80	100	150	200	Volts	
Maximum Average Forward Rectified Current at Derating Lead Temperature	I _O	3.0										Amps
Peak Forward Surge Current 8.3 ms single half sine-wave superimposed on rated load (JEDEC method)	I _{FSM}	80										Amps
Typical Current Squared Time	I ² T	26.5										A ² S
Typical Thermal Resistance (Note 1)	R _{θJA}	40										°C/W
	R _{θJL}	10										
Typical Junction Capacitance (Note 3)	C _J	200										pF
Operating Temperature Range	T _J	150										°C
Storage Temperature Range	T _{STG}	-55 to + 150										°C

ELECTRICAL CHARACTERISTICS (@TA=25 °C unless otherwise noted)

CHARACTERISTICS	SYMBOL	SR320	SR330	SR340	SR350	SR360	SR380	SR3100	SR3150	SR3200	UNITS	
Maximum Instantaneous Forward Voltage at 3.0A DC	V _F	.55			.75		.85				Volts	
Maximum Average Reverse Current at Rated DC Blocking Voltage	I _R	@T _A = 25°C						0.2				mA
		@T _A = 100°C						2				mA

- NOTES : 1. Thermal Resistance : At 9.5mm lead lengths, PCB mounted.
2. Measured at 1 MHz and applied reverse voltage of 4.0 volts.
3. "Fully ROHS compliant", "100% Sn plating (Pb-free)".

RATING AND CHARACTERISTICS CURVES (SR320 THRU SR3200)

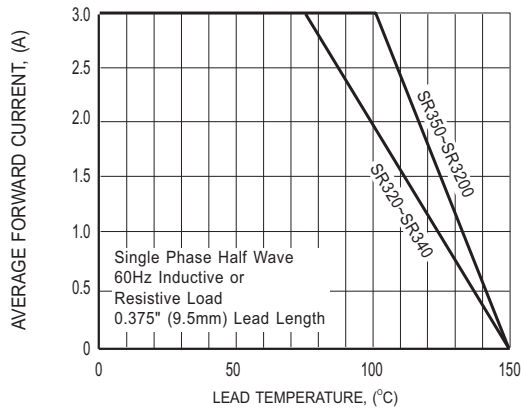

FIG.1 TYPICAL FORWARD CURRENT DERATING CURVE

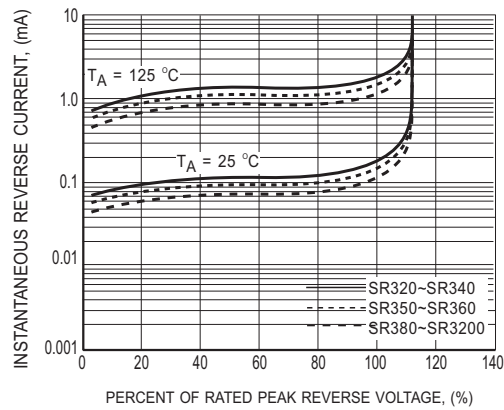

FIG.2 TYPICAL REVERSE CHARACTERISTICS

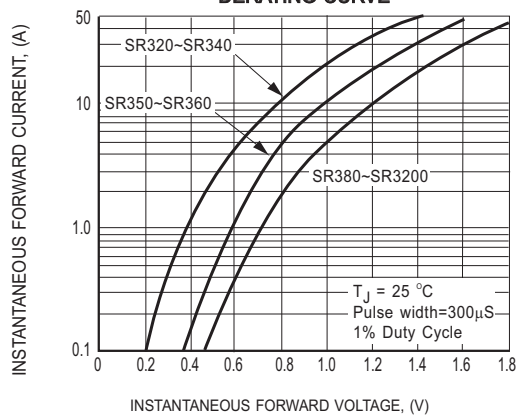

FIG.3 TYPICAL INSTANTANEOUS FORWARD CHARACTERISTICS

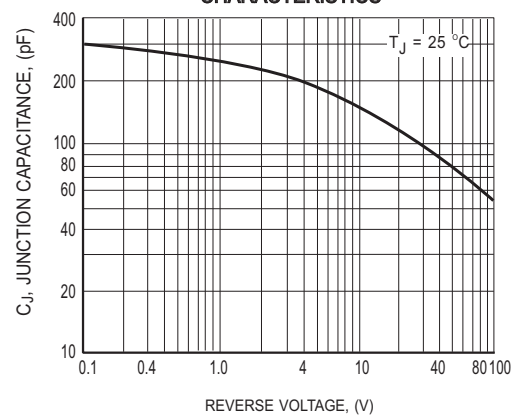

FIG.4 TYPICAL JUNCTION CAPACITANCE

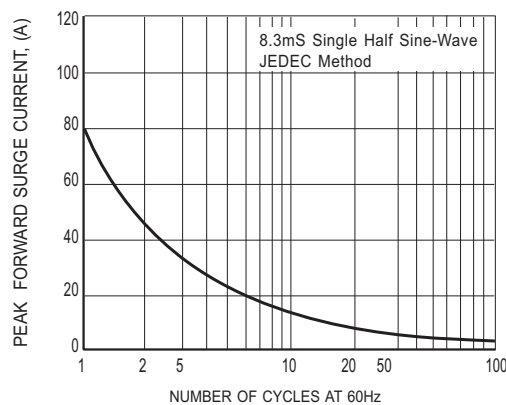
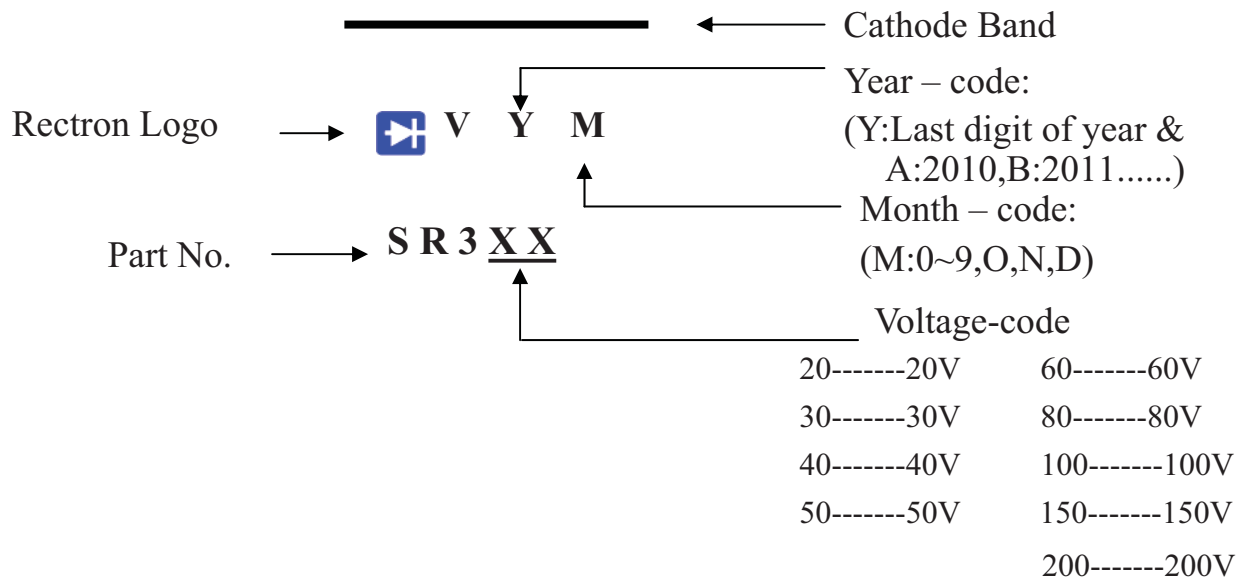

FIG.5 MAXIMUM NON-REPETITIVE FORWARD SURGE CURRENT

Marking Description



PACKAGING OF DIODE AND BRIDGE RECTIFIERS

BULK PACK

PACKAGE	PACKING CODE	EA PER BOX	INNER BOX SIZE (mm)	CARTON SIZE (mm)	EA PER CARTON	GROSS WEIGHT(Kg)
DO-201	-B	500	300*73*40	347*320*271	12,000	15.9

REEL PACK

PACKAGE	PACKING CODE	EA PER REEL	EA PER INNER BOX	COMPONENT SPACE (mm)	TAPE SPACE (mm)	REEL DIA (mm)	CARTON SIZE (mm)	EA PER CARTON	GROSS WEIGHT(Kg)
DO-201	-T	1,200	1,200	5.0	52	330	355*350*335	4,800	9.10

AMMO PACK

PACKAGE	PACKING CODE	REEL (EA)	COMPONENT SPACE(mm)	TAPE SPACE (mm)	BOX SIZE (mm)	CARTON SIZE(mm)	CARTON (EA)	GROSS WEIGHT (Kg)
DO-201	-F	600	9.5	52	255*73*100	400*268*225	6,000	9.9

DISCLAIMER NOTICE

Rectron Inc reserves the right to make changes without notice to any product specification herein, to make corrections, modifications, enhancements or other changes. Rectron Inc or anyone on its behalf assumes no responsibility or liability for any errors or inaccuracies. Data sheet specifications and its information contained are intended to provide a product description only. "Typical" parameters which may be included on RECTRON data sheets and/ or specifications can and do vary in different applications and actual performance may vary over time. Rectron Inc does not assume any liability arising out of the application or use of any product or circuit.

Rectron products are not designed, intended or authorized for use in medical, life-saving implant or other applications intended for life-sustaining or other related applications where a failure or malfunction of component or circuitry may directly or indirectly cause injury or threaten a life without expressed written approval of Rectron Inc. Customers using or selling Rectron components for use in such applications do so at their own risk and shall agree to fully indemnify Rectron Inc and its subsidiaries harmless against all claims, damages and expenditures.